

ÉCOLE DE TECHNOLOGIE SUPÉRIEURE
UNIVERSITÉ DU QUÉBEC

THESIS PRESENTED TO
ÉCOLE DE TECHNOLOGIE SUPÉRIEURE

IN PARTIAL FULFILLMENT OF THE REQUIREMENTS FOR
THE DEGREE OF MASTER CONSTRUCTION ENGINEERING
M. Eng.

BY
BALTUCH, Edmund George

A MULTI TIER BARCODE BASED SYSTEM FOR THE CONSTRUCTION
MANAGEMENT OF INDUSTRIAL GRAVITY VENTILATION EQUIPMENT

MONTRÉAL, MAY 12, 2008

THIS THESIS HAS BEEN EVALUATED

BY THE FOLLOWING BOARD OF EXAMINERS

Dr. Edmond T. Miresco Thesis Supervisor
Département de génie de la construction à l'École de technologie supérieure

Prof. Dominique Bauer President of the Board of Examiners
Département de génie de la construction à l'École de technologie supérieure

Prof. Hughes Rivard Jury
Département de génie de la construction à l'École de technologie supérieure

ACKNOWLEDGEMENTS

I would like to thank my thesis advisor and academic mentor Dr. Edmond T. Miresco ing. PhD. who did more than shepherd me through this academic process. Dr. Miresco was a guiding force in my pursuit of knowledge, thought and academic understanding. I am truly grateful.

I would like to thank the members of my Jury for the time and effort on reviewing my research work. I would like to thank all the professors who taught the courses that were part of the requirements for this course. Their knowledge and wisdom were shared in a spirit of collaboration and openness. I would like to thank l'École de Technologie Supérieure and its direction for providing me with an irreplaceable academic experience and opportunity.

I would like to thank my wife Renee and son Philip, who gave up many evenings and weekends with me so I could pursue my academic research.

I would like to thank my parents Siegmar Baltuch ing. Mech Eng. McGill 1956, and my mother Charlene Baltuch.

I would like to thank Air-Therm inc. and their staff for their corporate partnership and their access to key parts of their corporate and engineering data. To the in-house engineering staff, factory workers and site engineers, thank you.

I thank all the researchers whose words and work my research required as a foundation and all my ancestors whose lives, experiences and genes are who I am. A carbon offset has been made by me for the trees utilized in the writing of this research paper.

A MULTI TIER BARCODE BASED SYSTEM FOR THE CONSTRUCTION MANAGEMENT OF INDUSTRIAL GRAVITY VENTILATION EQUIPMENT

BALTUCH, Edmund George

RESUME

Un système de code à barre, d'architecture multi niveau, a été conçu et implanté pour la gestion de la construction des équipements d'aération industriels. Le but de l'étude a été de déterminer la possibilité d'implémenter un système de gestion d'inventaire mené par des codes symboliques pour donner un meilleur niveau de contrôle à la direction du projet et un niveau d'information plus accru pour les intervenants décideurs avec le but d'être plus vite, moins dispendieux et respectant les devis du projet. Un plan en trois phases a été exécuté (audit, pilot, déploiement) avec un groupe de contrôle quantitatif, pour examiner la viabilité et la capacité pratique de l'hypothèse qui est: est-ce qu'un système de code à barre, d'architecture multi niveau, va optimiser la gestion de la construction des équipements d'aération industriels. Le projet a démontré que l'hypothèse est valide. Les résultats du projet peuvent être appliqués sur des projets semblables et ont le potentiel pour l'optimisation sur un groupe de projets large et varié.

Mots clés : Gestion de construction, Code à barre, gestion d'inventaire, gestion de la chaîne logistique

A MULTI TIER BARCODE BASED SYSTEM FOR THE CONSTRUCTION MANAGEMENT OF INDUSTRIAL GRAVITY VENTILATION EQUIPMENT

BALTUCH, Edmund George

ABSTRACT

A Multi tier barcode based system was designed and implemented for the construction management of industrial ventilation equipment. The purpose of the study was to ascertain if it was possible to implement a symbology based inventory control system that would allow both project direction to control and team members at all levels to have access to better information with the goals of faster, less expensive, better quality project completion. A three phase audit, pilot project and full project roll out was implemented with a quantitative control grouping to examine the viability and practicality of the hypothesis which was, would a multi tier barcode based system optimize construction management of industrial gravity ventilation equipment. The project demonstrated that the hypothesis was valid. The findings of this project can be applied to further similar projects and have widespread potential for the optimization of a large and varied group of construction projects.

Keywords: Construction Management, bar code driven inventory control, supply chain management

TABLE OF CONTENTS

	Page
INTRODUCTION.....	10
CHAPTER 1 REVIEW OF THE LITERATURE.....	18
1.1 Historical Background of Barcode Driven Systems.....	18
1.2 Current state of the Art for construction inventory control	21
1.3 Summary of Review of Literature.....	26
CHAPTER 2 DESCRIPTION OF PROCESS.....	27
2.1 Historical Background of Process Building Ventilation.....	27
2.2 Evolution of Gravity Ventilators.....	29
2.2.1 Components.....	30
2.2.2 Documents.....	31
2.2.3 Specifications.....	36
2.3 Globalization of Ventilation Marketplace.....	40
2.4 Summary of Description of Process.....	44
CHAPTER 3 SYSTEM AND INNOVATIONS.....	46
3.1 Systems and Innovations Required to Implement.....	46
3.2 Summary Systems and Innovations.....	51
CHAPTER 4 METHOD AND PROJECT IMPLEMENTATION.....	52
4.1 Declaration of Experimental Research Methodology.....	52
4.2 Proposed Methodology of Implementation.....	53
4.3 Proposed Methodology of Comparing System.....	55
4.4 Summary of Introduction of Methodology.....	56
4.5 Audit.....	56
4.5.1 2 Suggested Systems: Passive and Active.....	57
4.6 Pilot Project.....	67
4.7 Summary of Pilot Project.....	73
4.8 Roll Out.....	73
4.9 Summary Method and Project Implementation.....	88
CHAPTER 5 OBSERVATIONS OF IMPLEMENTATION.....	89
5.1 Observations.....	89

5.2	Summary of Observations.....	98
CHAPTER 6 CONCLUSION AND DISCUSSION.....		100
6.1	Conclusion.....	100
6.2	Strategic Positioning and Viability.....	100
6.3	Industrial Implications.....	104
6.4	Future Research.....	104
APPENDIX I PHOTOS OF AIR-THERM GRAVITY.....		106
VENTILATOR PROJECTS		
APPENDIX II SAMPLE DRAWINGS AND INVENTORY.....		128
CONTROL SHEETS		
APPENDIX III DEMONSTRATOR READ-OUTS OF.....		139
MONITOR RESULTS		
APPENDIX IV AIR-THERM VENTILATOR TECHNICAL.....		154
DATA SHEET		
APPENDIX V PHOTOS OF QR CODES SCANNED.....		167
REFERENCES.....		174

TABLE OF CHARTS AND FIGURES

	Page
Figure 1.1 Tzeng et al Diagram 1 of Mobile Barcode System.....	22
Figure 1.2 Tzeng et al Entity and Relationship Diagram of Mobile Barcode System	23
Figure 1.3 Tzeng et al Process Diagram of Mobile Barcode System.....	24
Figure 1.4 Tzeng et al Diagram 4 of Mobile Barcode System.....	25
Figure 3.1 Photo 1 Dimensional and 2 Dimensional Barcodes.....	50
Figure 4.1 Project Challenges.....	52
Figure 4.2 Matrix of Project Rollout.....	53
Figure 4.3 Project Team Nexus.....	54
Figure 4.4 Steel Angles Awaiting Processing.....	60
Figure 4.5 Fabricated Components.....	61
Figure 4.6 Component Assembly.....	62
Figure 4.7 Evolution of Codification.....	65
Figure 4.8 Prototype.....	67
Figure 4.9 Pilot Re engineering Project 1	68
Figure 4.10 Pilot Re engineering Project 2.....	69
Figure 4.11 Pilot Re-engineering Project 3.....	70
Figure 4.12 Pilot Re-engineering Project 4.....	71
Figure 4.13 Information Process.....	72
Figure 4.14 QR Code.....	74

Figure 4.15	Evolution of Wireless Technology.....	76
Figure 4.16	Mobile Supply Chain.....	78
Figure 4.17	Project Lifecycle.....	79
Figure 4.18	Project Lifecycle Construction Components.....	80
Figure 4.19	3 Dimensional Model.....	83
Figure 4.20	Components Being Scanned.....	84
Figure 4.21	Status Monitor.....	85
Figure 4.22	Project Lifecycle Management Deliverables.....	86
Figure 4.23	Project Lifecycle Management Link to ERP.....	87
Figure 5.1	Timeline.....	89
Figure 5.2	Cost.....	90
Figure 5.3	Cost of time delay in data mining.....	92
Figure 5.4	Earned Value Analysis Data Mining.....	93
Figure 5.5	3D Modeling of Project Variables.....	96
Figure 5.6	4D Modeling of Project Variables.....	97
Figure 5.7	5D Modeling of Project Variables.....	98
Figure 6.1	Innovation Nexus.....	102
Figure 6.2	Forces of Change.....	103

INTRODUCTION

Statement of the problem

This Research project proposes to develop, utilize and evaluate a barcode based construction management system as a method of optimizing project control in the design, fabrication and construction of industrial gravity ventilation equipment.

The research project's hypothesis is that a convergence of technologies and availability in the market of innovations and technologies means the implementation of a mobile supply chain management system can effectively be utilized with a leaner schedule (less time/less man hours per project), higher quality outcome and lowered costs. By designating all documents and all parts with unique barcode designations, using PDAs, and having a central web portal to manage the information flow, could construction management dynamically control the entire supply chain management, from design through installation? (As seen in figure 4.16).

Traditional inventory and supply systems which continue to be in place in the local construction sector, have long served in markets that have been sheltered from technological improvements for a number of geographic and historical reasons, are now outmoded and have fallen far behind methods and approaches that have been adopted by many other industries, such as aerospace, automotive, and even the retailing industries, and other societies, such as Taiwan, Japan and others where there is less market fragmentation with in the construction industries and more investment in research and development . Traditional inventory control systems, compared to the efficiencies which will be demonstrated in more state of the art systems, are wasteful of time, money, and deliver a project which requires a higher level of re-engineering and quality defects.

Without a more reliable methodology to track deliverables within the project program the project engineer, project procurement team, project expeditor, and construction site engineer

are less able to control and assure the best outcome (within a framework of cost, quality and price) possible. In a globalizing marketplace, there is an increasing need to apply innovative construction engineering practices, in order to compete both in terms of construction firm to construction firm and technology-to-technology.

Purpose of the study

Many of the capacities once relegated to desktop personal computers are now available in mobile formats. The ability to acquire and send data directly from a location seemed immediately to hold promise in streamlining (faster, less expensive and with a lower rate of errors), the acquisition and communication of project data.

By 2006 and the beginning of this research, a convergence of technologies:

- Mobile Application Platforms
- Cellular technology
- Personal Digital Assistants (PDA)
- Improved bar code technology
- Increased bandwidth over cellular networks
- WiFi Technology
- Improved Java software solutions
- Integration middleware to move information between software packages
- Better and reasonable printing solutions for marking
- A greater understanding of Lean Construction techniques

Had led us to the question: could the application of supply chain management techniques and inventory control methods as used by the aerospace and automotive industry be utilized to improve the constructability of construction projects ?

Outside the scope of the project's contractual specifications a decision was made to attempt a pilot utilization of passive bar coding, to ascertain whether it would improve and streamline our supply process from design to installation of the equipment.

Research Question and Hypothesis

The objective of this research project is the development and implementation of a barcode based system using inventory technologies in order to improve the quality and constructability of industrial gravity ventilation equipment, while lowering the overall project costs and planned schedules.

Using bar code technology and inventory controls used in other industries for supply chain management, the quantitative research shall analyze whether these tools can be applied to uses in the construction sector.

The criteria used shall be quality, scheduling and cost savings.

As stated above, the Hypothesis is that a convergence of technologies and availability in the market of these tools means the implementation of a mobile supply chain management system can effectively be utilized with a leaner schedule (less time /less man hours per project), higher quality outcome and lowered costs.

The research project is cognizant that as oppose to a manufacturing process, construction projects are:

- One time singular events
- At a unique location and environment
- Assembling a team which does not generally work together

Due to these idiosyncrasies, the technologies and theoretical parameters of a supply chain management system must be engineered to apply to the construction sector and in the

design, engineering, fabrication, delivery, modular pre-assembly and installation of industrial gravity ventilation equipment.

Summary of content of the research paper

Chapter 1 is a review of related literature. Because this study is innovative, the body of knowledge for the application of barcode driven construction management is small. However, inventory control work carried out in other industries and other supply chain management applications can be seen to provide a predictive basis that the theorem is sound and is applicable to the construction sector.

Chapter 2 is a description of natural gravity ventilator design, fabrication and construction, the sector that they are a part of and some of the challenges, which a changing world has imposed on their construction management. The design, fabrication and construction of gravity ventilators provides insight into the challenges facing many others as well. Photos be found in Appendix 1.

Chapter 3 is a description of the systems and innovations required for a barcode driven construction management to work. Without the convergence and reasonable availability of particular technologies in conjunction with proprietary technology and innovative engineering it would be impossible to develop the presented system.

Chapter 4 is a description of the barcode-based system for the construction management of industrial gravity ventilation equipment. Three phases were conducted:

- An audit, where a specification was developed.
- A pilot project: where the process was tested to establish if it would work.
- A roll out: application of the barcode driven construction management system. on half a project with the other half acting as a comparative group.

A visual representation of this can be found in figure 4.2.

Chapter 5 described the implementation and observations. By utilizing the barcode based multi-tiered inventory control system a project that had a planned schedule of 10 working months (300 calendar days) (design, fabrication, jobsite work, rectification of deficiencies) was completed in 242 days. It should be noted that the team working with traditional methods completed their project in 270 days (design, fabrication, jobsite work, rectification of deficiencies), some of which can be explained due to the competitive nature of the experiment. The section of ventilators, designed, inventoried, expedited, transported, assembled and installed utilizing the described barcode based system, was constructed 22 % faster (man hours utilized) and with a cost that was 24% lower in terms of cost out side of material (material costs were essentially equal for both types of construction).

Chapter 6 is the conclusion and resultant discussions. Application of the experimental barcode based inventory control system saved the project in question time, money and produced a project with less remaining deficiencies. By automating certain tasks and allowing different teams to communicate, collaborate towards a common goal, optimized results are possible. By making an initial investment in time and capital, a significant gain in the end result was made. As has been demonstrated elsewhere, decisions made early on in a project are more likely to have a more significant effect on the final outcome of any project.

A number of derivative benefits were discovered, such as traceability, the potential to implement the basis of a computerized maintenance management system after the construction management phase is completed, and the widespread applicability of this technology to other industries.

Definition and Terms

Nature of Research

This research project has been carried out utilizing a quantitative research methodology.

After an audit of available resources and the creation of a pilot project (one shot experimental case study), which would give rapid prognosis, and observing the strong potential for a successful result, a pretest-post test control group design for a complete project roll out was executed.

By assuming that all tradesmen and engineers are equal we can declare that in equal groups the manpower required for the study were fully randomized. Due to the nature of the particular project, it was possible to have a control group working side by side with the group implementing the experimental system. It was immediately obvious to know who was part of the experimental group and who was not..

Basically one group used the supply chain management system and then other did not. Being on a jobsite together (in the field, in the lunch shack and after work hours) both teams immediately recognized that management was implementing a test system.

Workers were asked to refrain from discussing the system between the experimental and control groups.

From an engineering standpoint this meant assembling the required information and specification, designing a system specific to the proposed application, implementing the system and then verifying the performance, using empirical data.

Experimental group was given PDAs with barcode reading capacities. The data was transmitted via the web enabled cellular service to a web portal which collected and utilized the data. The experimental group could request and download information from the web portal which pertained to the work which they were executing.

The duration of the experiment from start to finish was the portion of a project life cycle from receipt of the Award of contract (about 14 months from initial client contact) for approximately 12 months to final installation of goods at jobsite.

Confidentiality

Due to the confidentiality agreement signed between Air-Therm, the client and a number of process equipment manufacturers involved on this project, the name and location of this project must remain confidential. This is typical in the field of Aluminium Smelter construction where any technical advantage that might render the smelter better performing allowing for the cheaper product of metal is closely guarded.

Repeatability

The findings of this research experiment are currently being repeated on other projects by this same sponsor therefore demonstrating that this integrated barcode driven construction management system will optimize project resources saving time and money.

A major American Metal and Mining group is currently investigating the potential of implementing this system on a complete project (not simply the ventilation systems).

Based on the findings on the succeeding pages, this same type of system (marginally customized for many different applications), could be repeated with a similar level of performance improvement found.

Importance of the Study

By developing, and demonstrating the validity of the proposed hypothesis, the research and applied experiment, gives the construction management a new tool by which significant savings can be made in time and money, and by doing so this should lead to other areas of innovation which should improve construction project results and the willingness of investors to risk their capital in other construction project ventures.

Summary of Introduction

The problem that this study attempts to resolve is that traditional inventory control has significant room for optimization. Can the new tools that are now reasonably available allow for the development and rollout of a bar code based construction management system? A review of the literature of such a system are presented, however the system in itself is new and therefore has not been attempted before. In order to ascertain an answer, the paper proposes to develop, and deploy a barcode based construction management system. The metrics to be used deciding the validity of the hypothesis are time, costs and ability to perform (quality and specification). The hypothesis will be found to be valid and have numerous other realistic and marketable applications as an engineered tool for construction management.

CHAPTER 1

REVIEW OF THE LITERATURE

Because this study is innovative, the body of knowledge for the application of barcode driven construction management is small. However, inventory control work carried out in other industries and other supply chain management applications can be seen to provide a predictive basis that the approach is sound and is applicable to the construction sector.

1.1 Historical background of barcode driven construction management systems

To this point no construction specification for a gravity ventilator has requested symbology based inventory control system. Most engineering, procurement, construction management consultant/engineers continue to follow specifications for markings, which rely on tagging systems which offer little value beyond a visual inventory control system. Therefore all experimentation with symbology based inventory control by this experimental project was carried out outside the scope of any project requirement or specification. It is believed by the author that this research is both original and innovative as it is the first of it's kind in this area of construction management. Therefore, there was little direct literary background for the experimentation undertaken.

The concept of machine-readable methods of information representation in a visual format for automatic identification and data collection was developed starting in 1948 by Silver and Woodland at Drexel Institute of Technology and protected by United States Patent 2 612 994.. The fundamentals of their work can be traced all the way back to the loom controllers of (Bouchon and Falcon 1725). As opposed to the punch cards of International Business Machine's Hollorith calculators of the late 1930s and early 1940s (Randell 1994), the barcode system developed by the Drexel team relied on the use of lasers and not physical contact. In the early 1960s further significant work was carried out at the laboratories of Sylvania electric corporation by Alexander and Stiem, however most of it remained in the

realm of theory and scientific research, being economically impractical. The concept, as stated, was far ahead of what was commercially and technologically feasible at the time. Although pilot projects were initiated in the late 1960s and early 1970s, initial commercialization of barcodes technology and inventory control methodologies in the mid 1970s had to wait for the convergence of two key industrial innovations to occur: Cheap lasers and integrated circuit boards. By the mid 1970s a milliwatt helium-neon laser could easily match the 500 watt beam utilized by the Drexel team. As will be demonstrated, in 2008 laser beam technology can be entirely replaced by digital cameras.

Once the convergence of AT and XT computers occurred in the late 1980s running early IBM OS2 and Microsoft DOS operating systems the potential for widespread application of retail barcode was truly possible (Seideman 1993).

A 1970 study by McKinsey and Company of New York evaluated that the grocery industry would save \$ 150 million per year (in 1970 dollars) by adopting a barcode inventory control system. On April 3, 1973 the grocery industry adopted the Universal Product Code, which standardized the look, application and coding of all grocery products. This meant that all UPC codes could be read by appropriately set up stores. (Seideman 1993 ; McKinsey & Co. 1970).

American Supermarket chains were the first practical applications of symbology based inventory control systems at their point of sales (check out counters). A check out clerk reading barcodes would be significantly faster and make significantly less data entry errors than utilizing the traditional method of checking out shoppers, speed up the check out process, reduce labour costs and to a degree improve customer service: (Clodfelter 1998).

As technologies further improved and convergences of technologies simplified applicability of systems, the distribution network (suppliers) were beginning to utilize the barcodes for distribution, and stocking.

The United States Post Office was a significant driver in the early stages of modern bar code development. However the early systems required specialized reflective material which limited system applicability.

Since then numerous applications have utilized symbology technologies to facilitate the tracking, readings, separation and indexing of particular items and documents:

- Airlines to control passengers and their luggage
- Document control in government and hospital applications
- Automotive and Aviation manufacturing industries

What all these application have in common is that they are essentially part of a closed supply/demand chain of production which differs from the construction sector where every project is unique in construction, location and affected by significant external elements.

It took only 15 years after Michael Porter's book "Competitive Advantage: Creating and Sustaining Superior Performance", for the requirement of understanding and implementing value chain analysis to the construction of aluminium smelters. Essentially the hypothesis proposed by Porter is that every area of a business process needs to bring added value to the final product. Capturing this value allow for suppliers, projects and industries to become competitive and there successful, (Porter 1998).

By implementing a review of the current state of the art, the realistic technological potential for inbound logistics, operations and outbound logistics and understanding the potential for converging available technology to optimize project performance in these areas, the basic conclusion to explain the rationale behind this experiment was clear.

The work of Henry Gantt (1910) forms one of the cornerstones of any construction management system. This research is based on the fundamental understanding and precepts of this work. The goal of this study is based in the tradition of cost engineering, to optimize and limit the use of the resources at hand in terms of manpower, technology, material and capital.

Prior to applying barcodes to a barcode code based construction management system, the basics of how to design, utilize, implement and roll out barcodes was sought by reading and following the methodology as presented in the general guide by Bushnell (1998) "Getting Started with Barcode".

Bell and McCollough (1988), Bernold (1990) and Rasdorf (1990) have attempted to test and develop bar code applications and technology for the construction environment. However their work was carried out in the late 1980s and the technology has changed completely since then therefore the only areas of their study which remain significant was the premise of applicability of such systems.

1.2 Current state of the Art for Construction Inventory Control

Tseng and Dzung (2005) developed a theoretical model for a mobile construction supply chain management system, which was a useful guide to developing and applying a theoretical model to a real world condition. The Taiwanese construction industry is significantly more integrated than the Canadian model and therefore there were particular changes which had to be instituted for these system to be implemented. They can be seen in figures 1.1, 1.2 , 1.3, and 1.4. A recent study was published by Shehab (2005) by the Canadian Society for Civil Engineering also builds on the same areas.

Tseng and Dzeng (2005) had important sequence diagrams, which were studied and followed.

Mobile construction supply chain management

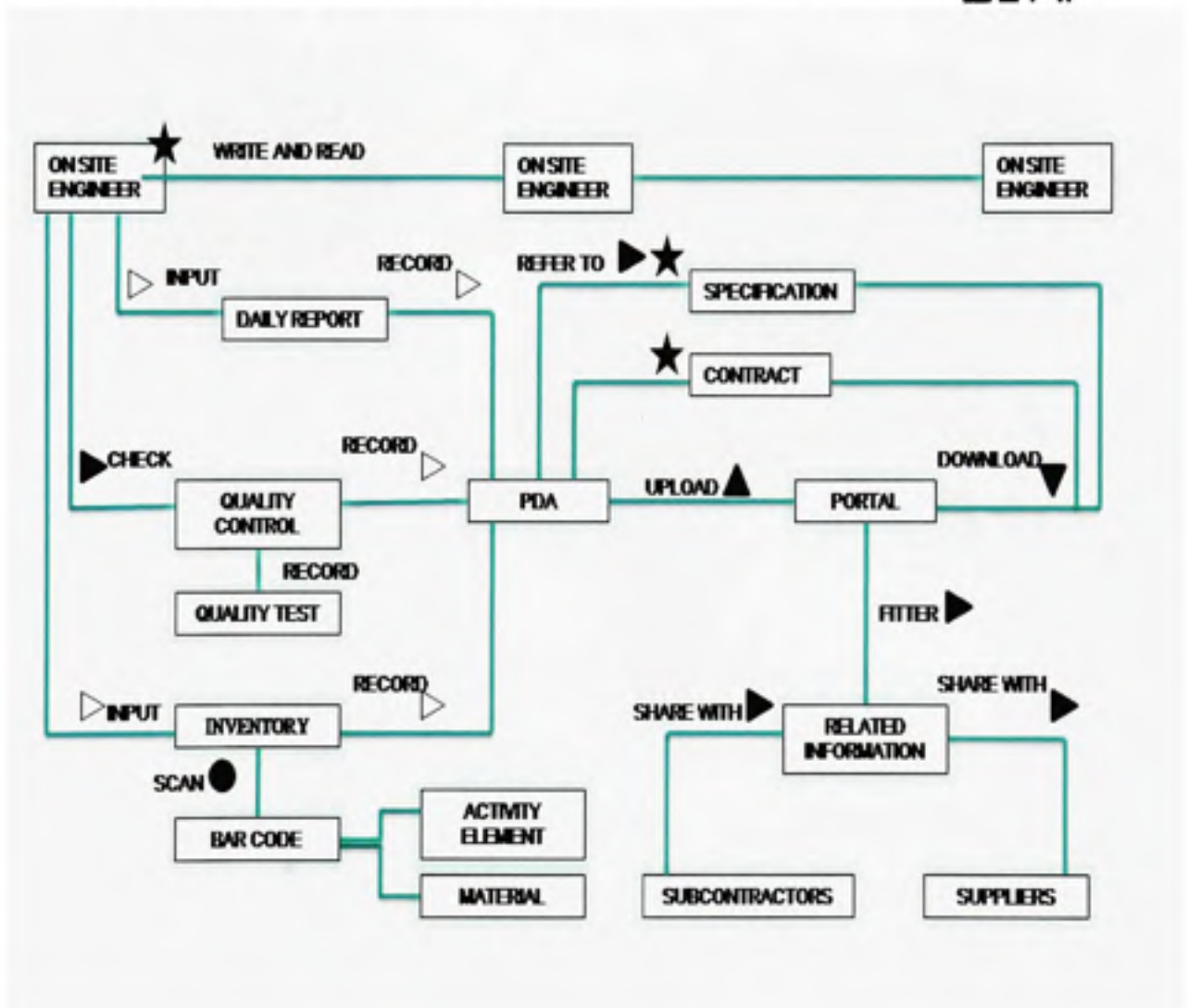

Figure 1.1 Diagram 1 of Mobile Barcode System
(from Tseng and Dzeng, 2005)

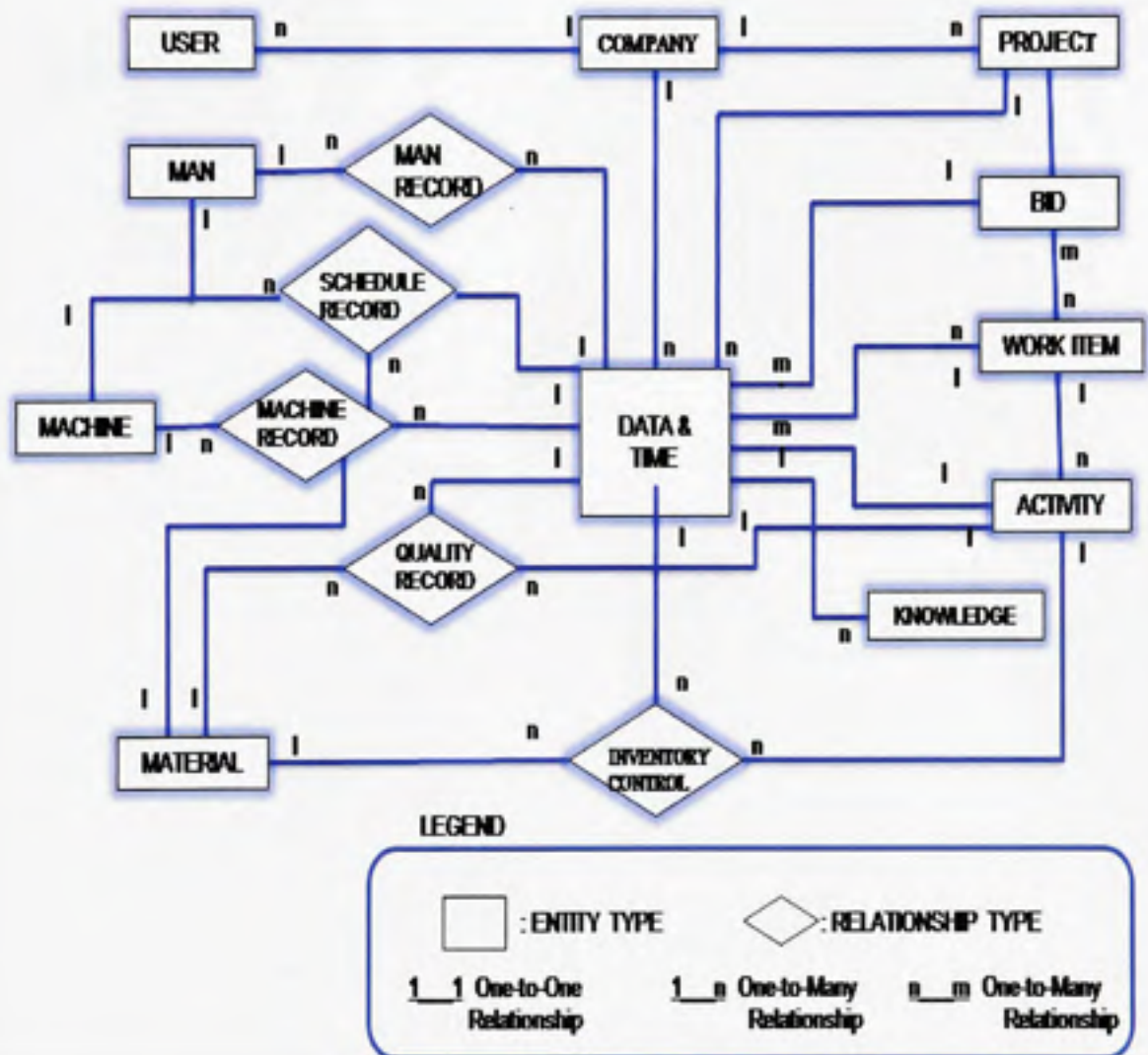

Figure 1.2 Entity and Relationship Diagram of Mobile Barcode System
(from Tseng and Dzeng, 2005)

MOBILE CONSTRUCTION SUPPLY CHAIN MANAGEMENT

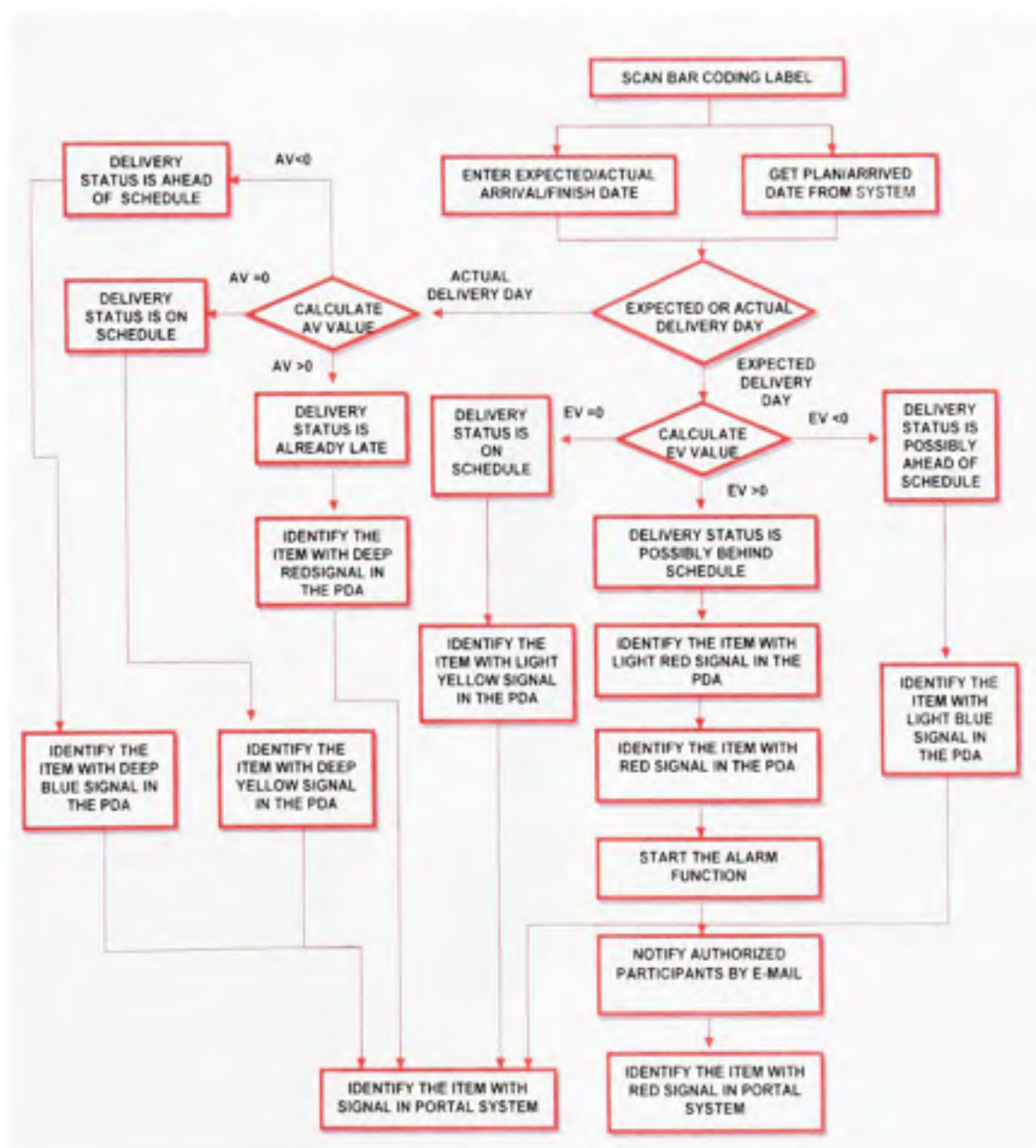

Figure 1.3 Process Diagram of Mobile Barcode System
(from Tseng and Dzeng, 2005)

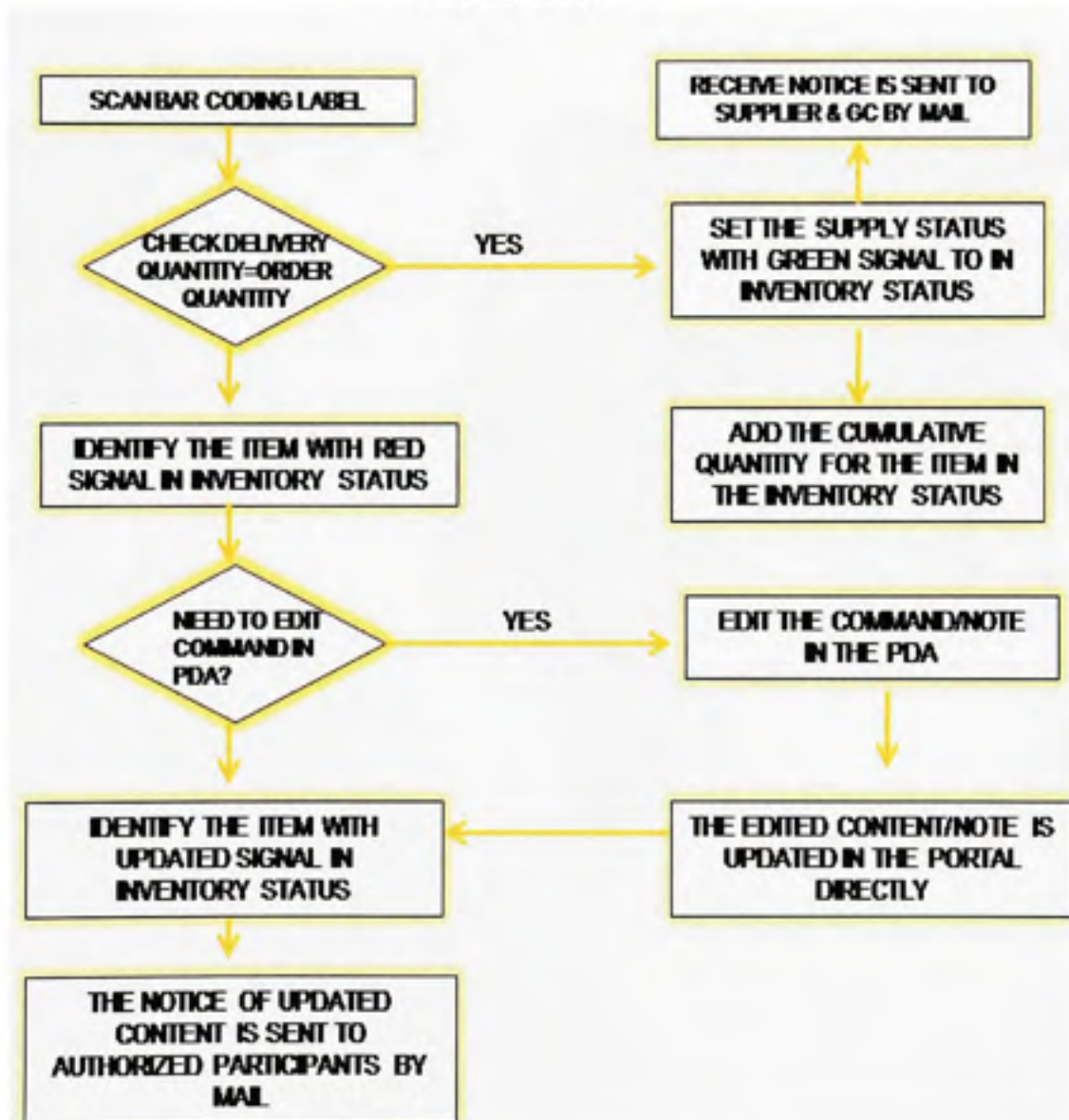

Figure 1.4 Diagram 4 of Mobile Barcode System
(from Tseng and Dzeng, 2005)

However these logic boards did not assist in developing some of the more practical and basic parts of the construction management system. Based on this literature survey, the question was asked: Would it be possible to converge technologies applied in other sectors, and theories proposed for the construction sector to plan, develop and implement a working barcode based construction management system for the construction of industrial gravity ventilators?

1.3 Summary of Literary Review

Because this experimental research project is innovative and utilizes a convergence of technologies that have only recently been available, the body of knowledge for the application of barcode driven construction management is small. However, inventory control work carried out in other industries and other supply chain management applications can be seen to provide a predictive basis that the approach is sound and is applicable to the construction sector.

CHAPTER 2

DESCRIPTION OF PROCESS

The scope of this research project is the implementation of a multi tier supply chain management system utilizing bar codes in the construction of gravity ventilators. Even though the gravity ventilators themselves are a backdrop for the implementation of a Mobile Supply Chain Management system, some knowledge and understanding of these systems is essential in following and understanding the research project. Photos of this process can be found in Appendix 1.

2.1 Historical background of process building ventilation

In process type buildings such as Steel Mills, Glass Plants and Aluminium Smelters there is a need to allow heat to be removed from the plant environment, allow a regular number of air changes per hour within the plant environments and to ensure that the process environment remains weather resistant under process operating conditions.

This process, has been understood from the time King Charles I of England decreed in 1600 that ceilings should have 10 foot ceilings and that windows should be taller than wider to allow better smoke extraction.

In 1914 the American Society of Heating and Ventilation Engineers (the predecessor of ASHRAE) published that 50 cubic meters of air per hour per human was a minimal standard. This amount was reduced in 1989 by ASHRAE /ANSI standard 621989 to 27 cubic meters of air per hour per human.

According to Ventilation of Potrooms in Aluminium Production (Holt, 1999) “Potrooms for the production of aluminium are preferably naturally ventilated” (as opposed to being ventilated by power exhaust systems: power ventilators)

The article demonstrates that if one compares the two main ventilation principles, on many different level, natural ventilation is by far the better of the options.

Natural Ventilation occurs by two different means:

Wind driven natural ventilation, where the topography of the building is studied to create a building shape where either by pressure or suction, the warm air within the building is drawn to the exterior. This system is reliant on a particular constant minimal wind factor (C_w) which can generally not be assumed for most industrial building applications

Stack effect natural ventilation, where the differential of temperature and pressure between two bodies of air creates a buoyancy in the air stream of the air body within the process building. This sort of system must work in all wind conditions including zero wind conditions.

Within the building there exist a Neutral Plane. Below this line air is drawn into the building, above this line air is exhausted the larger the distance between the ingress and egress, the greater the chimney effect (therefore the velocity of air and therefore the total quantity of heat that can be extracted from the inside of the process building.

Gravity Ventilation is a form of Stack Effect Ventilation.

Process Building is a building within which a heat producing transformation of materials is taking place, such as the smelting of non ferrous metals, hot rolling process of creating steel, or the production of glass products.

Within the buildings a very high quantity of heat (as described in kilowatts or British thermal units) is produced and must be exhausted to conform to nation building stands and in a number of cases national hygiene standards.

The buildings are designed to have inlet air ingress at the lowest point possible, with simple opening, adjustable inlet louvres or inlet air panels and ventilators at the zenith of the building roof. The reason for this is to maximize the potential chimney effect which is the driver for moving air in and then out of the process building.

For the purpose of general engineering, the natural ventilation flow rate can be estimated with this equation: (ASHRAE 2001, p.26.11)

$$Q_S = C_d A \sqrt{2 g H_d \frac{T_I - T_O}{T_I}}$$

where:

Q_S = Stack vent airflow rate, m^3/s

A = cross-sectional area of opening, m^2 (assumes equal area for inlet and outlet)

C_d = Discharge coefficient for opening

g = gravitational acceleration, 9.807 m/s^2

H_d = Height from midpoint of lower opening to neutral pressure level (NPL), m

NPL = Location/s in the building envelope with no pressure difference between inside and outside

T_I = Average indoor temperature between the inlet and outlet, K

T_O = Outdoor temperature, K

2.2 Evolution of Gravity Ventilators

Gravity ventilators have evolved from being doghouses or penthouses, which were simply raised sections of the top parts of the process building's peaked roof, with the two side of the raised section left open to allow from heat and fume exhaust to a specialized engineering design feature which allows a calculated flow of air, and heat exhaust while insuring that the building remain weather resistant under positive operating conditions.

Attached to the annex section of this research project is a brief photographic archive of Steel mills and Aluminium smelter buildings from the late 19th and early 20th century to compare to the photos of Gravity Ventilators installed on modern steel mills and aluminium smelters.

2.2.1 Modern Gravity Ventilators are defined using of up to 7 different elements

- A. Documentation
 - Drawings
 - Specifications
 - Assembly Manuals
- B. Structural Framing
 - Frames
 - Bolts
- C. Roll Profiled Cladding
 - Cladding
 - Fastener Systems
- D. Fabricated Sheet Metal Components
 - Components
 - Fasteners
 - Mastic products
- E. Airflow/Heatflow Control registers
 - Frames
 - Sheeting

- Bolts and Fasteners
- Mechanical Components
- Electrical Components
- F. Integrated Laser system / optical devices (confidential systems)
 - Laser systems
 - Structural Supports Systems
- G. Integrated Submicronic Capture Magnetic pulse Filters
 - (confidential systems)
 - Mechanical components
 - Electrical Components
 - Framing Material

The equipment is installed on buildings that range from 200 linear metres in length to over 4000 linear metres in length with a structural frames on 1.5 to 3.3 metres centerlines.

Documentation for the ventilators can be broken down into:

2.2.2 Drawings

Approval drawings: After the receipt of an order (contract or purchase order) from a client or their agents, there is a specified obligation to submit shop drawings or approval prints. These drawing will include all material and specifications for the proposed supply. It is during this phase that the client and the vendor will further clarify the precise supply.

Required during this phase may be the supply of the results of finite element testing (such as P-frame) specific to the ordered design, computer generated CFD (computational fluid dynamic) modeling of heat flows and the building and inspection of sample ventilator sections to be inspected and approved by the project's civil, mechanical and architectural teams.

Samples of particular materials proposed to be used may be required so that they may be examined and a project review may be conducted.

It is standard for a project to use a grading system for these submitted documents. Once project approval is granted: the next phases of engineering may commence.

Fabrication drawings

Fabrication drawings of structural, mechanical, electrical and architectural elements must follow the agreed specification of the approval drawings.

It is during this process that engineers will designate symbology codes for each and every component. (see chapter 3: detailed description of barcode system and its requirements). Codes will also be designated for all documents to be utilized during the project (drawings, purchase orders, project specifications, inspection reports, and expediting reports).

A certain logic must be utilized in the fabrication of components to best utilize structural materials with the least amount of waste. Example if a length of steel angle is 40'0" in length, and therefore can be cut into 4 lengths of approximately 10'0" (minus loss due to cutting), it would be uneconomical to design a structural member that is 10'3" in length unless the other approximately 9'3" is being used for some other element with a ratio of 1 component for every 3 longer components.

From the fabrication drawings, cutting lists are derived which allow the procurement department to order the appropriate materials to both complete the project specifications and the required quantities. Due to the remote nature of most projects, the limitations of shipping and the size of most assembled gravity ventilators (8 metres wide, 5 metres high, by 2 to 4000 metres in length) ventilators are transported to jobsite in knockdown form.

Assembly and Installation drawings (See Appendix 2)

Based on the approval drawings (which were based on client received drawings of the project buildings), and fabrication drawings, detailed assembly and installation drawings and written instruction manuals are created specific to every project.

These drawings and instructions will allow site personnel to open containers, initiate and carry out and complete the assembly and installation of the gravity ventilators.

Even though submittal drawings and assembly plans will agree on all features shown, the assembly/installation manuals will have significantly greater detail, either not required by the project's engineering team or confidential: such as the symbology based inventory control system (not part of the project's specification) however allowing the Air-Therm team a significant technological and commercial advantage.

As will be shown later, utilization of the symbology based system will greatly enhance and improve this entire process and will create a much easier and closer relationship between the design engineers, fabricating team and the jobsite crews responsible for the final product.

Cutting lists (documentary support of fabrication drawings)

Efficient utilization of material and raw material inventory control are key components to any well organized supply chain management system.

During the design phase, design engineers, in consultation with the engineering team which will lead the fabrication effort will agree on the minimum quantities of lengths of structural steel and sheet metal which will be required to optimally complete the project.

The most efficient cutting list will have the highest percentage of material utilization with the lowest possible percentage of material wastage.

In the past a great deal of engineering experience went into designing cutting lists. A structural designer could easily pay for his annual salary or at the very least improve his annual bonus by his careful utilization of material cutting and reduced material wastage.

Recently a number of software packages have become available that will integrate into Autodesk CAD, Microstation and CATIA design packages, such as Rastervec SmartCut, SIATEC FurniCAD, Optimalon Software GNCutter. These will reduce a company's dependence on the particular skills of particular employees, therefore reducing the required training and experience to derive an acceptable result if the optimal result arrived at by more highly trained/skilled workers (read: better paid employees).

The utilization of these systems has been advanced by the Aerospace industry who are prime light metal sheet metal users and the residential pre-engineered building industry.

Compared to the most experienced sheet metal designer, these systems still are not as effective, however in general they allow a better level of material utilization. (Discussion of these software systems are outside the parameters of this paper, but some review and surveying was carried out).

Cutting of material and punching of material is a significant step in Air-Therm's fabrication process both in their structural steel works sheet metal shop and mechanical/motor works.

These are first places that Material is received from the suppliers is received and begins their fabrication process.

It is also a point where a \$ 24,000 coil of Aluminium, a bundle of 3" by 3" by ¼" ASTM 50W can easily go missing and have the highest value to any other user. Once the material passes this point it's only value added utilisation is as parts of an Air-Therm Gravity Ventilator. Other than that, it is only worth it's scrap value.

It is the first place where workers can make mistakes, lose material, and value.

If a coil of aluminium is incorrectly processed, example: 98" lengths of sheets are required, however the machine is set to 96" standard sheets, no corrections will be able to remediate the lost material.

In all three cases (structural works, sheet metal and motors works), the foremen leading these departments are longterm Air-Therm employees that are trusted annually with millions of dollars of inventory and their initial processing.

For the past 45 years of Air-Therm's fabrication processes, similar to the controls utilised in most Quebec fabricating facilities, the foremen received a cutting list, selected material, and cut the material length checking off drawings and keeping a record of works in small notepads.

This relies on highly experienced particular workers. Therefore the outcome of careful inventory control, discretionary selection of bulk/raw material to be processed and control of initial errors in production is not systemic in any way.

Introduction of symbology based inventory control: material traceability

These materials shall also be assigned symbologies to allow for their inventory control and traceability during building, operation and maintenance phases of the project's life. The relevance of this step is both for cost control and to allow material traceability back through to mill tests reports for all materials utilized in a particular project.

Within the symbology of all fabricated parts there will be a link to the coils of sheet metal, and/or bundles of structural steel lengths utilized.

By implementing a symbology based system, the decision making process and the recording of inventory controlled, coils selected for processing and material fabricated can be

managed in a more systemic manner and is less reliant on a small group of highly experienced workers rather are based on an engineered system which once implemented can deliver a minimum standard assured performance. The minimum standard for performance shall be set by the most stringent requirements and specifications of the systems and projects to be delivered and therefore all projects requirements and specifications shall be met.

2.2.3 Specifications

A large majority of greenfield (new construction projects) and brownfield (expansion project of existing primary process facilities) follow a similar process of specification development.

End users (single process facility clients or joint ventures that have pooled their resources to finance and then share the end product to develop new capacity) either utilise in house capacity or engage the services of an engineering firm to engineer, procure, construct and manage the facility for them.

These engineering firms work with equipment suppliers determine the project's equipment requirements, develop specifications for the design, supply and installation of the required systems.

This process will occur, initially when the engineering firms themselves are bidding to offer their services to the end user, they require an estimate of project scope and costs to be able to present to the end user.

As these orders can be worth in excess of 15 % of the total project scope, project management/engineering firms are keen to demonstrate their abilities to deliver on time, and under budget a process facility that will deliver the specified product .

Feasibility studies:

- Bankable feasibility when the client is seeking exterior financing (the demonstration is that there is a financial benefit to building the new capacity).
- Inclusion of innovative systems such as symbology based inventory control systems demonstrates to non technical financial partners that with minimal technical understanding, they will be able to have live project information and be aware of where their dollars currently are and that efficiencies are being put in place to streamline costs.
- Environmental Impact Assessments when the client is trying to sell the project to communities where a new neighbour will be spending 500 Million dollars to 5 billion dollars and changing their lives and their children's lives forever, inclusion of innovative systems such as symbology based inventory control systems demonstrates to non technical community partners that with minimal technical understanding that even if they do not have access to live detailed information that care is being taken to reduce the project footprint (by requiring less project personnel and shortening the construction phase of the project).

Both these types of documents will be massive in size and scope trying to convince bankers, politicians and then local communities to partner with these projects.

Specifications for Gravity Ventilators will specifically state criteria in the following areas:

HVAC specification: air hygiene requirements for environment conditions at work floor levels, weather resistance under positive operating conditions for the particular application and particular location (Sept-Iles Quebec is quite different than Tannum Sands Queensland even if the process is very similar).

STRUCTURAL REQUIREMENTS: Local Building codes to be followed. Note: physical properties are physical properties however each jurisdiction has it's own methodologies to demonstrate structural integrity.

ARCHITECTURAL REQUIREMENTS: This might deal with methods of sheet metal constructions, colors of material to be used and issues which might effect the building envelope. Note as aluminium smelters are generally steel structures with aluminium cladding, due to conductivity issues related to the electrolysis process, much concern must be given to the differential of expansion coefficients between steel and aluminium (almost double).

Also outlined in the specification there will be such areas as the relationship between project and supplier, inspection, expediting, shipping, documentation, billing, payment and guarantee related to the supply.

Once financing for the project is found (successful bankable feasibility) the local community is on board (successful environmental assessment) and the boards of the concerned companies give a green light, a project management team is selected.

There are many methods for this selection to occur, however this subject is outside the scope of this study. What is important is the understanding that even though a closed bid process will occur to award an order for the supply of the gravity ventilation equipment, being involved with the end user and the engineering groups carrying the initial design work means that the plant design and specification will include elements specific to Air-Therm's design and supply such as the symbology based inventory control system. The latter which might be a key selling point for both bankers and local communities and therefore critical components in both the financial proposal and the community's assent to the project.

Industrial gravity ventilators (continuous ridge ventilation), are engineered products designed, engineered, and supplied to the primary process heat type buildings namely: steel

mills, aluminium smelters, glass plants and other similar industries. In the past, regional suppliers supplied regional projects. This meant that projects were near at hand (local), the construction and engineering teams worked closely together and many of the same team worked repeatedly on the same projects.

In this way, hand written lists and chalk markings on components was sufficient for the skilled craftsman to understand the intent of veteran engineer. A set of assembly plans carefully sketched on a wooden drafting table were sufficient for the jobsite engineer to lead his team of men. If corrections were required, they were carried out in the field rarely with any comment or correction to drawings. Due to lack of competitiveness in the marketplace, there was less of a need to closely monitor cost controls. Lost components could be re-fabricated and replaced within days if not hours.

Due to technological advances in communication and transport logistics, primary material producers, are able to seek the lowest cost and most advantageous locations to situate their production facilities. In order to follow their customer base, as they have left their traditional fabricating locations and looked elsewhere, the construction industry related to the mining and metal sector has been forced to modernize and innovate.

As an example, when an aluminium producer is unable to arrive at an agreement for assured low cost energy from a traditional provider, they are now more able to negotiate and secure an alternative provider, who may have reasoned that providing a home to a primary industry in their location makes logical political and economics sense both in the short and long term. Discussion of this is outside the limitations of this project.

Since the mid 19th century industrialists have built both mining operations and metal transformation process operations in remote locations. Whether in Northern Canada or Siberia or Sub Saharan Africa, these efforts were carried out sometimes with great cost in capital and human lives. The advent of technological innovation has allowed these types of projects to be carried out in an efficient, planned and safe manner.

2.3 The beginning of a globalizing market place. The beginning of the challenge.

In 1993, the Aluminium company of South Africa (ALUSAF) engaged SNC-Lavalin of Montreal, Quebec to act as their engineering, procurement and construction managers for the Hillside Aluminium project in Richard's Bay Natal Republic of South Africa. SNC had been the engineers for a numbers of phases of the construction of Reynolds Metal's aluminium smelter in Baie Comeau Quebec and more importantly in 1990 to 1992 had assisted Bechtel Corporation in the construction and engineering management of both Alumax's Luralco smelter in Deschambault Quebec and the Alouette Aluminium's smelter in Sept-Iles Quebec. As South Africa looked to convert their excess coal in hard currency, the production of an aluminium smelter was a logical choice.

SNC-Lavalin nor Alusaf did not feel restricted in inviting only South Africa suppliers to bid, but opened their bidding process to pre qualified suppliers from anywhere in the world. Although the South African firms had the advantage of have less cartage costs indexed to their bid proposals and a cost of labour which was substantially lower to many other industrialized nations, they were also hampered by a lack of competitiveness due to decades of political isolation in terms of technology and the need for price competitiveness. If you are a monopoly or oligopoly there is little need to lower costs or become more innovative.

What occurred was suppliers were chosen from around the world, and had to find the logistical resources to deliver (supply and in some cases install) the goods as per price, quality and schedule. For South African firms that wished to be successful, they had to raise their quality bar and lower their pricing.

In 1993:

- It was still difficult to put in a telephone call to Apartheid South Africa.
- Microsoft bundled MS Word and MS Excel together to create Microsoft office.
- Autocad Release 11 was the most current version of this well used cad software.

- The internet was not still a number of years away from mass utilization,
- Email communication was not yet a normalized method of communicating
- Cellular technology was still in it's nascent stages.
- A video conference was an extremely expensive and complicated undertaking.
- The Advent of the global fiber optic network which was built from 1995-2000 allowing a significant reduction in the cost of sending and receiving information and collaborating on a global scale was still 2 years away.

However many lessons were learned regarding inventory control and the coming globalized marketplace.

In 1995, Rio Tinto, embarked on it's expansion of the Boyne Smelter in Tannum Sands (near Gladstone) Queensland Australia. By now:

- Cellular telephone were becoming much more common
- Most desks had a desktop computer operating a Microsoft Operating System
- Design was being carried out in 2 dimensions using Autocad systems
- Letters were generally still being faxed
- Drawings were sent via courier rather than emailed
- The internet was still mainly DOS based

The engineers were Bechtel who had much experience with assembling a global team of experts. Many of these experts had suppliers from their home markets who were invited to offer proposal on this project. In the case of Air-Therm of Montréal, it's proposal was accepted over a competing Australian proposal on the provision that the equipment be fabricated in Australia of Australian materials. Air-Therm had proposed a superior technology, agreed to the project's fast track schedule and at a more competitive price. However due to distance between Canada and the project, shipping costs and logistics rendered the bid not as competitive. The answer for the project was to ask to supplier (at least in part) to move closer to the project.

In 1999-2000 Aluminium Company of Canada, built the Alma smelter project in Alma Quebec. Alcan (client) and Bechtel (engineers) attempted to bring a number of innovation to this project, in terms of construction modularization, and fast track scheduling. However, letters were still being sent via the fax, with original hard copies received by postal mail, document control was receiving and issuing drawing and documents in hard copies, weekly jobsite meetings still required having a representative on site or alternatively flying up to Alma for a weekly visit to the jobsite.

Inventory control in general was conducted with spray paint, grease markers, recorded by hand and then sent via fax.

The 2003 expansion of the Alouette Smelter, although with an increase in email correspondance, an increased utilisation of cellular telephones and digital cameras for transmitting photographs, inventory control was still carried out in the same fashion.

This project provided an interesting case to examine the challenges of sending equipment to a relatively distant project (850 km / 12 hour traveling), with a common language and culture. Due to winter weather conditions and the knowledge that Route 138 that connects Montréal to Sept-Îles can sometimes be closed for days at a time, it was critical to keep an adequate inventory of material for construction crew on jobsite. Further more, the leadership of the team on the jobsite was very familiar with the equipment being sent to them as many had over 30 years experience in assembling and installing the same equipment. Even with such an experienced team, there was a substantial degree of waste, loss, and downtime requesting further information to ensure that the correct equipment was being installed in the correct locations.

Weekly air trips from senior engineering personnel was required to resolve inventory, planning and logistic issues in order to ensure that the schedule and quality levels remained as per project contract specifications. These trips were expensive in terms of time and

money and created an additional environment burden to an already overburdened environment.

Here is a list of common questions on a construction site:

- Where was the material ?
- When is the next shipment arriving ?
- How can I tell part A1 from part A2 ?
- I used a part A1 instead of an A2: is it a problem ?
- How much inventory remains on site ?
- What has been installed ?
- What is currently in fabrication ?

In 2006 The Aluminium Company of America (Alcoa), finally moved forward on their greenfield smelter project in Eastern Iceland: Fjardaal.

Due to the extreme remoteness of this project, many innovations were brought to bear in order to attempt and ensure the total success of this project.

A camp was set up and workers imported on chartered planes. The engineering team was brought from around the world and encamped as well.

There was a push from the engineering firm to modularize as much as possible in order to reduce labour requirement and crantage at site.

Email fully took over from written letters, mobile telephones replaced land lines. However further technological improvements were necessary. Typically heavy industrial construction sites, tend to be spread out. A typical Aluminium Smelter project takes up 20 square kilometres. On site engineers and sector supervisors (typically lead tradesmen), often spend

much of their days traveling in order to find information, transmit information or attend meetings.

By reducing this misutilisation of time and resources, could decisions be taken more efficiently? With a lower rate of informational errors were strategic project decisions more likely to better focus project energies ?

This can be seen bi-directionally. The technology now available to permit the engineer on site to be able to capture the data and send the information to a web portal. This would mean faster data acquisition for the project. Further, by having a more "sure" method of capturing the information a clearer (having reduced human errors) picture could emerge for project direction.

The engineer on site is at the point of data utilization. Meaning he is accessing the required information at the location where the information is required and will be utilized to best serve the project. By bringing this information to the field, it will be studied whether there is a more efficient and surer form of implementation.

The use of passive one dimensional bar codes as keys to the project's web portal, have been shown by many studies to eliminate inventory recording errors, and is an easy call up system for information related to the document or parts in question.

Laptop computers are both cumbersome and fragile to be used in a construction environment. The advent of PDA using MS Mobile 5.0 and Pocket PC operating systems have allowed processes brought from the construction site office to a format more easily useable in the field and therefore requiring less duplication of tasks.

2.4 Summary of Description of Process

Ventilation has been required for heat and smoke producing buildings since metal has been smelt. Due to a convergence of technologies and world events the traditional local methods of smelter construction has changed to suit a global engineering, procurement and construction model. If Air-Therm is going to be able to continue to be competitive, it must now compete on a global scale, which will require innovation beyond what was required to compete in the local market.

CHAPTER 3

SYSTEMS AND INNOVATIONS

3.1 Systems and Innovations required to implement this project

Prior to the late 1990s, it would not have been commercially and technologically feasible to prototype and then implement a bar code based multi tiers system for project control. In the first place, there was no pressing need as the flattening convergences that have recently affected the construction of aluminium smelters had yet to occur and both suppliers and projects were sufficiently well served by the system, however archaic, that were in place.

The elements that allowed the implementation of this technology to occur have been easily available, lower costs web enabled mobile handsets, and stable configurable mobile application platform middleware. The concept is to take pre-existing assets, and to configure them in such a way that they can be used in a more efficient manner.

Example: Since the mid 1990s field engineers have been equipped with mobile telephones to allow to faster communication for both technical reasons and safety applications. Therefore as the mobile handsets are already being purchase implementing a further level of functionality does not require dramatically different equipment or training. Having the ability to extend additional applications to the same devices increases the rational for the cost involved in the initial purchase of equipment as well.

Prior to the late 1990s it was rare to see a desktop computer in the trailers of most contractors. Drawings and specifications were in paper form and communication was carried out in person, by telephone and by fax. In the past 10 years construction sites have seen a dramatic increase in the use of computer technology and Internet. As well workers have seen an increase penetration of personal computers in their own homes and therefore are significantly more receptive to using and dealing with computerized and automated

technology in the workplace. It will be noted in a later section of thesis that one of the big surprises of this experiment was how small the cultural barrier was to the introduction of this system. What was initially a big concern was solved through respect, communication and a feeling of team collaboration. Understanding a top down need for the acceptance of change, putting in place a system to reduce frustration when barriers required surmounting, understanding that every one had a part in all re-engineering and that refusing to collaborate was not going to be accepted at any level and that system recovery (which was not required) would be everyone's responsibility. By these efforts manpower involved in the process was brought on board with a comparatively low level of resistance.

As the drawings were already being codified and these codifications were already being prepared in a Microsoft Access environments (Microsoft database software, part of most Microsoft professional packages), adding an additional column of codification did not require significantly more time or training for the administrators conducting this work.

One initial barrier that required investigation and a solution was that wireless or mobile service in remote areas such as aluminium greenfield construction sites can be spotty at best (weak wireless connectivity). When service is available, it requires mobile handsets to operate in "roam" mode which can be significantly more expensive for voice utilization, and the sending and receiving of data bandwidth. The solution was the readily available acquisition and installation of wireless routers with powered antennas attached to the contractor's construction trailer.

Desktop computer, creating a secure, stable WiFi hotspot for the contractor's field construction

Another effect of this solution to a specific technical issue was the significant reduction in costs related to field voice and data transmission.

As the fabrication based team and field construction engineers were to carry out work conducting inventory control, expediting work, fabrication tagging, site inventory control and other tasks in a wireless application protocol environment on screens which are 75 mm x 75mm rather than a desktop based computer display screen, the information that was to be transmitted to these team members and the forms which they would be utilizing had to be configured for easy navigation on their handsets.

Therefore, all elements of the required convergence toward a barcode based inventory control system were already in place and most potential barriers were in effect easily surmountable.

As the goal of this research was to implement a prototype and then test the service on an actual construction project, there were certain budgetary constraints and observations made which recognized the limitation of the current architecture of the system engineered which could be overcome either by increasing the capital spent (more rugged field handsets) or allowing more time to pass (allow for further technological convergences). However the methodology utilized and experimentation carried out demonstrated the apparent and significant improvement to inventory control when a barcode system was put in place.

The current state of construction inventory control is the usage of chalk or grease marker and shipping lists or bills of lading. For those involved in fabrication control, expediting, transport, reception of goods at site, site inventory control, and many other construction processes it has meant significant paperwork. The ability to capture data utilizing a barcode based inventory control system means an immediate and significant reduction in the quantity of paperwork and data entry which they are required to complete. Many studies conducted by the retail commerce industry has demonstrated automated data entry has a significantly lower margin of error than manually entered data entry. In addition the data entry is conducted in a manner that is significantly faster, saving time and money in the execution of required tasks. (Clodfelter 1998).

Beyond a reliable methodology of applying symbology, this research project was reliant on a number of other technologies. Without these technologies the application of this project would have been impossible and although this research project may have used these technologies in a manner not used before, the technologies were provided by a list of other theoretical scientists and practical engineers far too long to enumerate.

Due to the rapidly evolving technology involved in this research project, different generations of technology were utilized. Web enabled mobile telephones are only beginning to penetrate the retail market and the potential for their application seems limitless. Since the early 1990s, Air-Therm has been providing key jobsite personnel with mobile telephones. The current generation of telephones allowed them to be used readily as part of this research project. The telephones are equipped with digital cameras that are capable of capturing and understanding the symbology utilized.

This research project was initiated utilizing commercial barcode readers in the fabricating facility and on jobsite and then attempting to utilize SDIO mounted barcode readers on web enable mobile handsets. These proved fragile and not conducive to the jobsite environment as they were affected by temperature and humidity. It was decided to utilize a 2 dimensional technology developed by Denso Wave a division of Toyota of Japan as part of their automotive just in time manufacturing process. The Java software patches required to allow a web enabled mobile handset were available at www.Kaywa.com and no cost was related to the utilization of QR code or the Java downloads.



Figure 3.1 *Photo 1 Dimensional and 2 Dimensional Barcodes*

During the course of this project, a leap ahead was made by utilizing WiFi (Wireless Fidelity, IEEE 802.11b wireless networking) hotspots, which saved a great deal of time and expense. Many scientists and engineers from many companies have been involved in the development and evolution of these technologies. However to the author's knowledge, this is the first application of utilizing these technologies in synchronous application for the construction management of the construction of gravity ventilators.

The advances in middleware which allows heterogeneous software languages to speak to each other was worked with. The research did not wholly develop this system, but instead utilized a Microsoft MySQL system to integrate information from different proprietary software packages. Similar, significantly more sophisticated middleware systems have been

recently developed by both Oracle and SAP, although not for the construction industry must be noted.

3.2 Summary of Systems and Innovations

For this research project to be feasible significant work had to be carried out and brought to market by thousands of other scientists and engineers. Without mobile telephony and computing as hardware, and without platform software, this research project would not have been possible.

CHAPTER 4

METHOD and PROJECT IMPLEMENTATION

This chapter describes the methodology utilized in the execution of the research experiment and then detail the experiment itself.

4.1 Declaration of Experimental Research Methodology

The methodology utilized to carry this experiment was a quantitative one, although some qualitative aspects could be derived from the data output.

The question posed was by replacing the traditional manual system of inventory control used by a supplier to the construction of primary aluminium by a barcode driven multi tier inventory control system could the work be carried out more effectively.

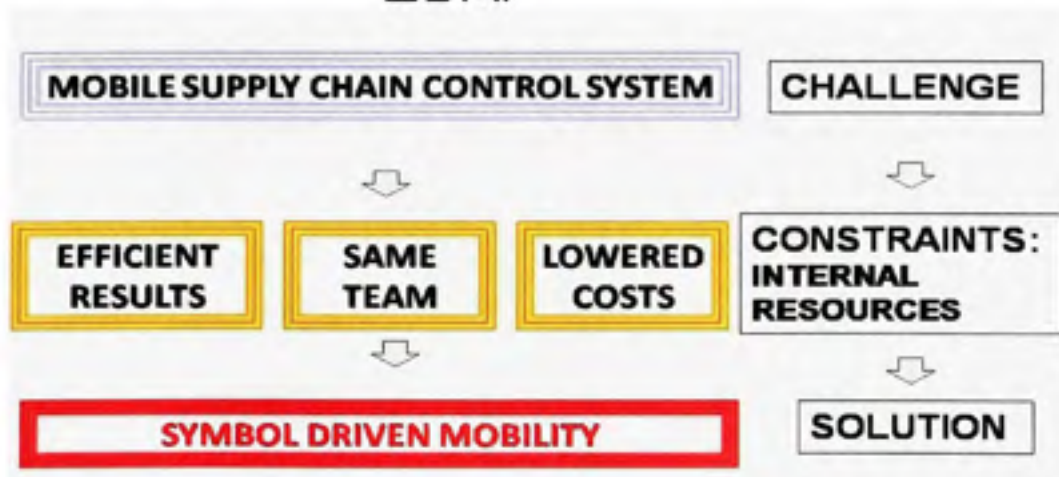

CE.G. BALZUCH 2008

Figure 4.1 *Project Challenges*

In order to determine this the criteria would be time, money and specification:

- Could the work be carried out for a lowered cost?
- Could the work be carried out in a shorter schedule?
- Were there fewer deficiencies at the end of the execution of each phase of the work conducted?

Qualitative standards were observed but are secondary to the most observable and quantifiable standard of time, money and specification. These qualitative items were:

- Was manpower quality of life improved?
- Was there a perception of increased project control?
- Were better strategic and tactical project decisions enabled?
- Was communication between engineering, fabrication and construction teams improved?
- Did the reduction in traveling reduce the carbon impact of the project?
- Did the reduction of paper used improve the project's ISO 14000 profile?

4.2 Proposed Methodology of Implementation

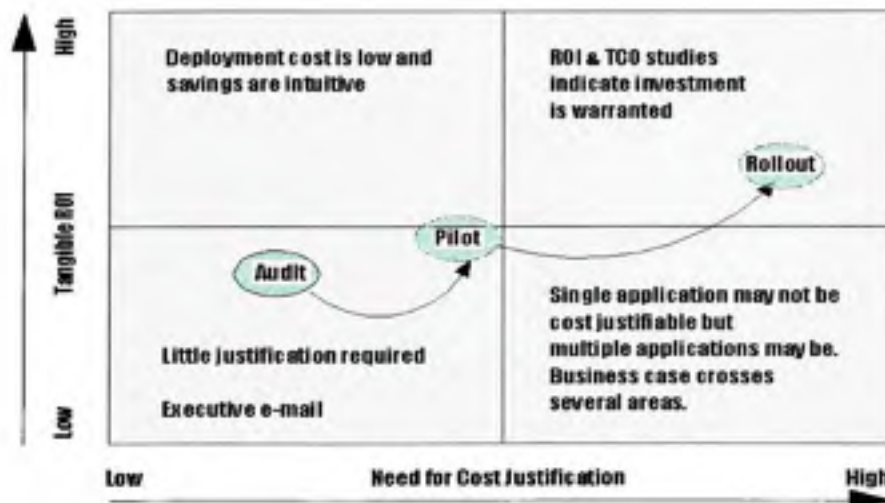
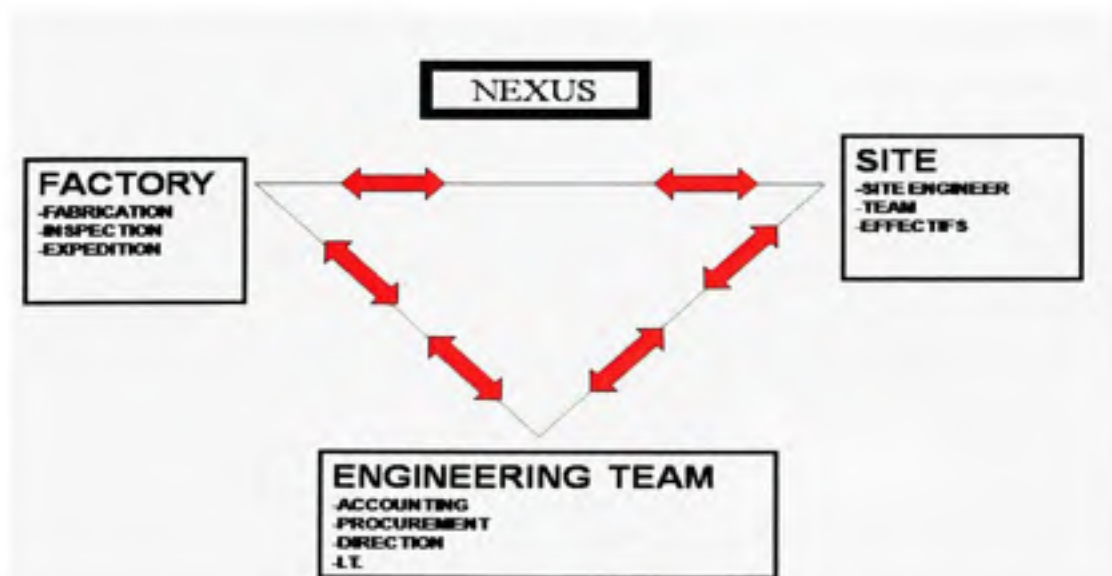

Figure 4.2 Matrix of Project Rollout

In order to properly implement and execute this experiment it was carried out in three distinct phase.

Audit: A complete audit was taken of the current state of supply chain management and inventory control system of Air-Therm Incorporated to understand what assets were available and what personnel were in place to carry out the current movement of goods and what parts they would be able to play in the implementation of a new system.

Prior to initiating a pilot project, key personnel at Air-Therm's engineering offices, fabricating plants and implicated jobsite were brought together to explain and discuss the planned experiment. Individuals were given the option to volunteer or opt out of the experiment. In order to validate the experiments hypothesis, it was important that all parties working diligently and understand the importance of the nexus between all areas of the company as shown in Figure 4.3.



CE.G. BALTUCH 2008

Figure 4.3 *Project Team Nexus*

Pilot: Prior to asking Air-Therm to commit to a new and untested system that could significantly affect the outcome of a multi million dollar project, a pilot project was put in place to familiarize key personnel with a proposed system and evaluate early on what technical barrier may require changing or optimizing. The study could be prepared to demonstrate that converging existing internal capacities with a barcode based system, could result in significantly improving project outcomes.

Roll Out: Taking the lessons learned during the pilot program, respecting the limitations, sensitivities and recommendations that decision makers with the client desired and applying the pilot process to an entire gravity ventilator project, or in this case half a gravity ventilator project.

4.3 Proposed method of comparing new system to traditional system

Control implemented during roll out: Because the smelter reduction cell potrooms of an aluminium smelter are traditionally built in tandem (one beside the other) it was possible to attempt to apply a barcode based inventory control system to only one of the potlines, while the other potline was constructed in the traditional manner. In this way it would be possible to study and understand the quantitative effects of the applied changes. This however was not a true control methodology as firstly the team that had the innovative experimental system was aware that their condition had changed and the team that was using the traditional methodology was equally aware that they did not. Therefore the concept of a placebo of any kind was not implemented.

Some of the differences can be attributed to a Hawthornian effect in that the teams working with the barcode based system were aware that they had something “new and special” and therefore this may have affected (improved) their performance.

However as the teams were divided in two from the outset of the roll out phase of the project, many competitive factor on both team may have come into play, improving or otherwise altering the outcome of the project.

4.4 Summary of introduction of Methodology

In the end, the goal was the engineered application of a scientific hypothesis where the criteria to demonstrate success or failure of the experiment was cost, time and specification which are in the end the three basis of the success or failure of all construction engineering projects.

4.5 Audit

Requirements

The need for using bar code technology is to reduce a point of friction in the manufacturing and installation phases of the project cycle and to further assist in the operating phase of the product as well. The goal is an improved supply chain from design phase through customer utilization.

The constraints of implementing bar code technology were

A. Cost

New system will require : time to implement the new system, bar code readers, the purchase of software and appropriate licenses, cost of training personnel to use the new systems

B. Management and Labour acceptance of new system

There will be a need to establish an awareness and positive outlook towards the new systems. Not simply for this technological innovation but for future innovations and opening the company to further proposals.

C. Training staff at different levels

There was a need to free up personnel to take the time to learn and train on the new system and accept a certain level of initial on the job errors and start up problems.

The objectives were to:

D. Improve inventory control

E. Lower cost of production, transport and installation

F. Improve product quality and utility

4.5.1 2 suggested barcode systems

Currently inventories were maintained using pen and paper methods.

Excel charts were created but the practical utilization had not progressed since it's inception. Management had been fragmented and disorganized. Losses and errors both in the manufacturing phases and on jobsites needed to be reduced if Air-Therm was to be able to compete in the long term.

Communication between engineering, fabrication and the jobsite were conducted via meetings, phone, fax, and the occasional email but there was no interactive means of creating a dynamic inventory control to streamline the entire process.

The goal was to re-engineer the inventory control process to create a dynamic live inventory control system.

As a proof of concept the research project suggested that a pilot project be implemented to demonstrate that inventory control using bar code readers would streamline this process. By implementing the project in a phased approach , both management and labour became more gradually invested in the project and because early successes were delivered, many were more willing to call the program their own.

Passive bar coding:

Equipment to buy: bar code readers, software, training .

As Air-Therm already kept material inventory lists, fabrication lists, material cutting lists, shipping lists, site inventory lists, installation lists, it was a matter of integrating this information into an automated and integrated solution.

The idea of integrating a bar codification system required from an initial engineering standpoint only an additional column line of information, but it will generate an entire level of information and control capacity.

The pilot process to be re-engineered is the barcoding of structural frames, stringer angles and bolts through reception of material through installation on site.

This process required a software package capable of creating barcode identification and interfacing with Microsoft Excel, and Industrial quality bar code readers.

Steel Angles are globally produced in 20, 40 and 60 foot lengths. 40 foot lengths are the Canadian standard.

Once the steel was received by Air-Therm individual lengths received a barcode (in the form of an adhesive sticker, printed on a standard laser printer, on a media designed for use on steel angles), which will inform the size, length and other information when read.

The steel angle is then considered in inventory. By reading the bar code it is known what the item is, when it was received, it will also be known when reading the bar code was scanned.

Inventory. (Important for further optimization of inventory control).

After the component is fabricated, a new bar code is put on the fabricated part with the part number. This is the part's permanent code, identifying its material, paint system, length, and date of fabrication, length, fabrication drawing, installation drawing, and potential location of installation.

The bar code is read again when the part is shipped, received on site, prepared for installation, installed and accepted by the client.

It was necessary to have bar code scanners (readers) in the fabrication facility, and on site. As a pilot we recommended two at each location to assure redundancy in case of equipment failure. There was also a need to have sufficient adhesive label to print the bar codes. As all locations already had PCs in use for other applications the only other requirement was installing the software.

This system allowed the engineering office, the fabrication shop, the jobsite engineer to have immediate information on what is in stock and where, allow for better planning and control of fabrication, transportation, inventory control at all locations and traceability of components even after installation.

Active bar coding (RFID)

A secondary solution considered was the use of Radio Frequency Identification Systems. These are essentially Bar Code systems that are operated by mini batteries that emit a frequency allowing for information gathering at a distance.

Rather than having to physically verify every part fabricated the parts would emit a message, which a reader would capture to know what parts were there.

A bundle of 50mm x 50 mm angle with a RFID tag could send an identifying signal while being inventoried. (Figures 4.4).



Figure 4.4 *Steel angles awaiting processing*

A bundle of parts fabricated and ready for transportation could send a message to the fabricating facility shop.



Figure 4.5 *Fabricated Components*

As the transport is received on site, rather than having to unload the truck and scan each and every part, the RFID bar code would immediately send their codes to the central system via a LAN which would make the information available to all that have system access to this information. If a truck has 5000 parts in a delivery, the work load of scanning these parts would be eliminated.



Figure 4.6 *Component Assembly*

In a 6 Sigma / Lean Construction environment a well organize RFID system may prove to significantly improve quality and reduce man hours.

This re-engineering pilot project would require RFID readers at two locations (therefore 4 scanners) a system capable of programming the RFID tags (not simply a printing operation) and software which is similar to the passive system

Disadvantages of RFID in an aluminium smelter environment is that if it is an expansion project with existing capacity, the magnetic field is very strong and the tag may not be able to correctly transmit their signal. Tags have some difficulty when used with metallic objects, however the tag manufacturer said that a remedy to this will come out on the market shortly. Our conclusion was not to use RFID tags for this application.

Cost benefit analysis in pilot project implementation.

For pricing of Bar code equipment the experiment found that online pricing for brand name products was very competitive.

The experiment used <http://idautomation.com/> for the purposes of estimation however would suggest that if a pilot project was successful and a complete re-engineering was decided upon that a reverse online auction event might be conducted to significantly reduce the procurement costs of these systems.

Passive bar code pilot project :

Bar code readers : Symbol Technologies MC1000 Batch Mobile Computer

$$\text{\$ } 735 \times 4 = \text{\$usd } 2\,940.00 \times 1.16 = \text{\$ } 3\,410.00$$

Labeling Software IDAutomation Barcode Label Software

$$\text{\$ } 139 \times 3 \text{ license} = \text{\$ usd } 417.00 \times 1.16 = \text{\$ } 483.00$$

Dedicated Label Printer Intermec C4 Barcode Printer Kit

$$\text{\$ } 479 \times 1 \text{ printer} = \text{\$ usd } 479.00 \times 1.16 = \text{\$ } 555.64$$

Training : 3 engineers (4 hours each) @ \\$ 62/ho = \\$ 744.00

2 factory workers (4 hrs ea) @ \\$ 24.00.hour = \\$ 192.00

2 jobsite workers (2 full days) @ 1000/day = \\$ 2 000.00

Pilot Project = \\$ 7 384.00

Active RFID coding system :

RFID readers [Symbol Technologies MC9000-G RFID Scanner Series](#)
 $\$3980 \times 4 = \$ \text{usd } 15\,920 \times 1.16 = \$ 18\,467.00$

RFID Software [IDAutomation RFID Label Software](#)
 $\$495 \times 3 \text{ license } \$ \text{usd } 1485 \times 1.16 = \$ 1\,722.00$

RFIF Printer from <http://www.scanplanet.com/RFIDprinters.asp>
 Zebra R110Xi RFID Printer $4,495.00 \times 1.16 = 5\,214.00$

Training : 3 engineers (4 hours each) @ \$ 62/hour	=	\$ 744.00
2 factory workers (4 hrs ea)@ \$ 24.00.hour	=	\$ 192.00
2 jobsite workers (2 full days) @ 1000/day	=	\$ 2 000.00
Pilot Project	=	\$ 28 339.00

Benefits of Barcode system:

Cost per manhour on jobsite is : \$70.00/manhour.

Cost per transport vary depending on location of project : however
 cost of a marine container Montreal to Fjardal Iceland is \$ 7 000.00.

Ton of fabricated steel is worth \$ 6 000.00.

Every day that a project is mobilised on site, cost Air-Therm \$ 4 000 of non personnel costs. (equipment, insurance, general administration)

Financing 500 tons of structural steel at a rate of 5 % per year is an important cost.

Observation of benefit:

If the passive system saves Air-Therm 2 days of construction, it has paid for itself.

If the RFID system saves Air-Therm 5 days on site it has paid for itself.

Client recommendation: client sensitivities.

Due to the low cost, if only one system is to be implemented as a pilot project, it would be a passive bar code system. This is for reason of initial cost to get client approval and for the problem of magnetic interference at Aluminium Smelters, mean this might be the more appropriate technological solution.

The figure 4.7 shows the evolution of barcode systems. This research project took an industrial partner from the traditional step up two innovations.

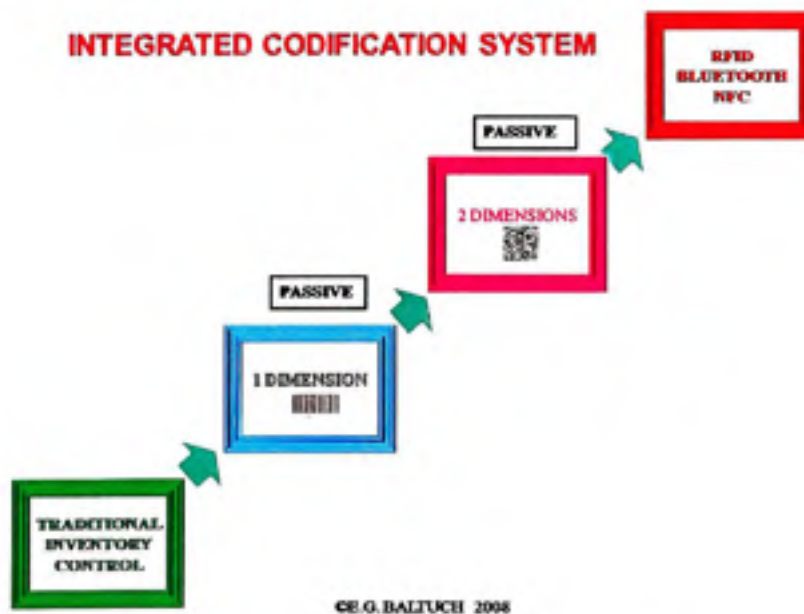

Figure 4.7 Evolution of Codifications

The implementation process recommended:

At first a recommendation was made to retain the hand written logs and grease marking on the steel while using the barcodes as well. If there were a problem with the barcodes or any misunderstandings both codes would be in place.

The idea for this came from when the Metric system was implemented in Quebec both miles per hour and kilometer per hour signs were posted by Transport Quebec in certain areas.

The three key players are the developing engineer , the engineer at the fabrication facility and the jobsite engineer. Having them informed and on board will champion the process. A sample of the new shipping list has been attached in Appendix 5.

We compared the Opticon and Symbol product ranges at a number of discount sellers <http://www.barcodediscount.com/cats/barcode-scanners/imager.htm> reviewed both company's websites <http://symbol.com/index.php> and www.opticonusa.com and found that in terms of pricing, canadian servicing and market reputation symbol seemed to be a safer decision for this pilot project.

4.6 Pilot Project



Figure 4.8 *Prototype*

The pilot project (figure 4.8) was carried out in 4 phases: planning, design, implementation and observation. The audit phase had given the pilot project most of the planning and conceptual basis. The work of Tzeng et al. of Taiwan was consulted to understand how they theoretically perceive such system should work and then it was integrated in the traditional methodology that had allowed Air-Therm to be profitable annually for the past 40 years. Implementation, described below was basically apply a computer readable standardized codification to every document and material to assist in the supply chain management of throughput goods. One of the great things about this construction engineering project is that the results were immediately seen and recognizable. This hypothesis was either going to be validated (and therefore supported) or be invalidated and not supported.

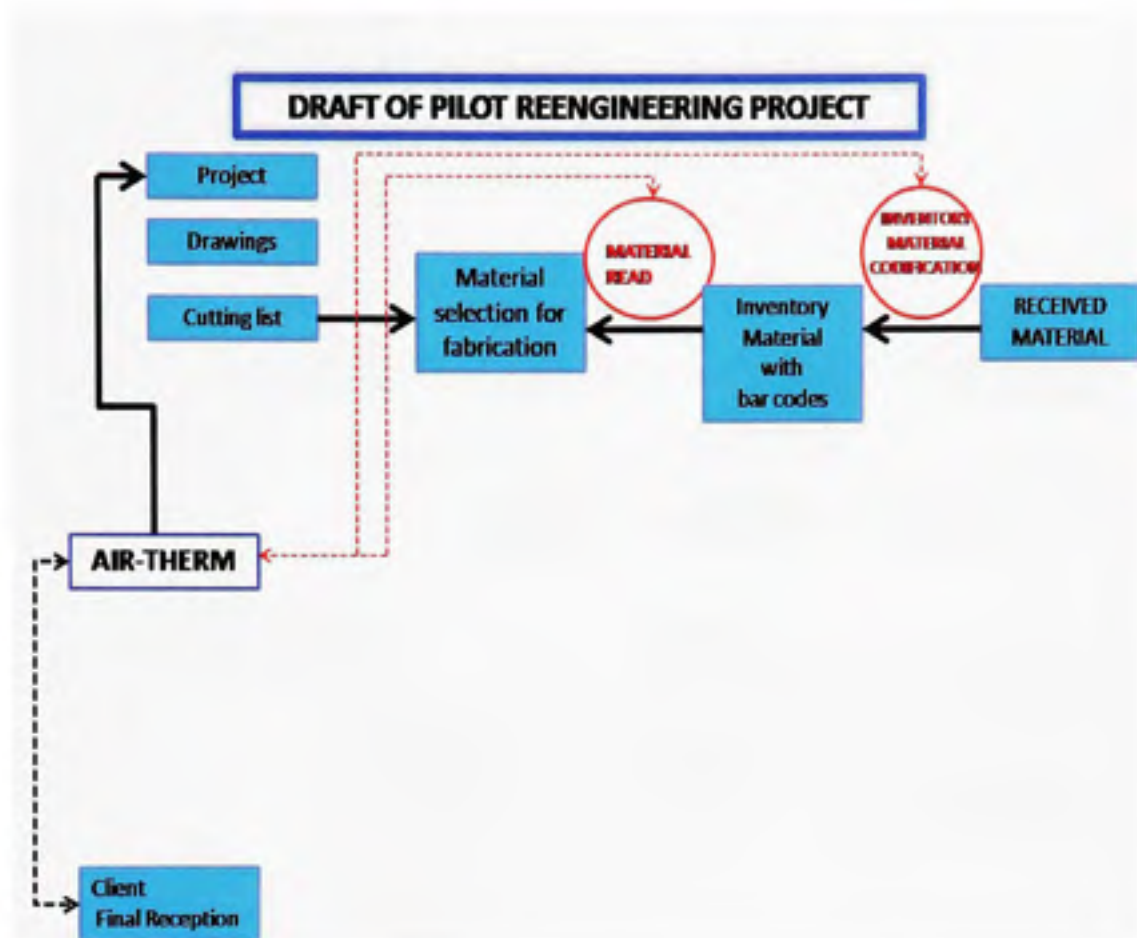

© P.L.G. BALI UC11 2008

Figure 4.9 Pilot Re-engineering Project 1

The figure 4.9 shows the traditional method in place with the location of where marking were verified and noted. Standard operating practice was to regularly fax inventory sheets to the engineering offices where accounting personnel were collecting the data, entering it in to an Excel format and transmitting to the project engineering team. The potential for input error and delays in issuing information were noted from the beginning of the pilot. Further because multiple projects are typical ongoing at the same time, the misallocation of goods was typical and prevalent.

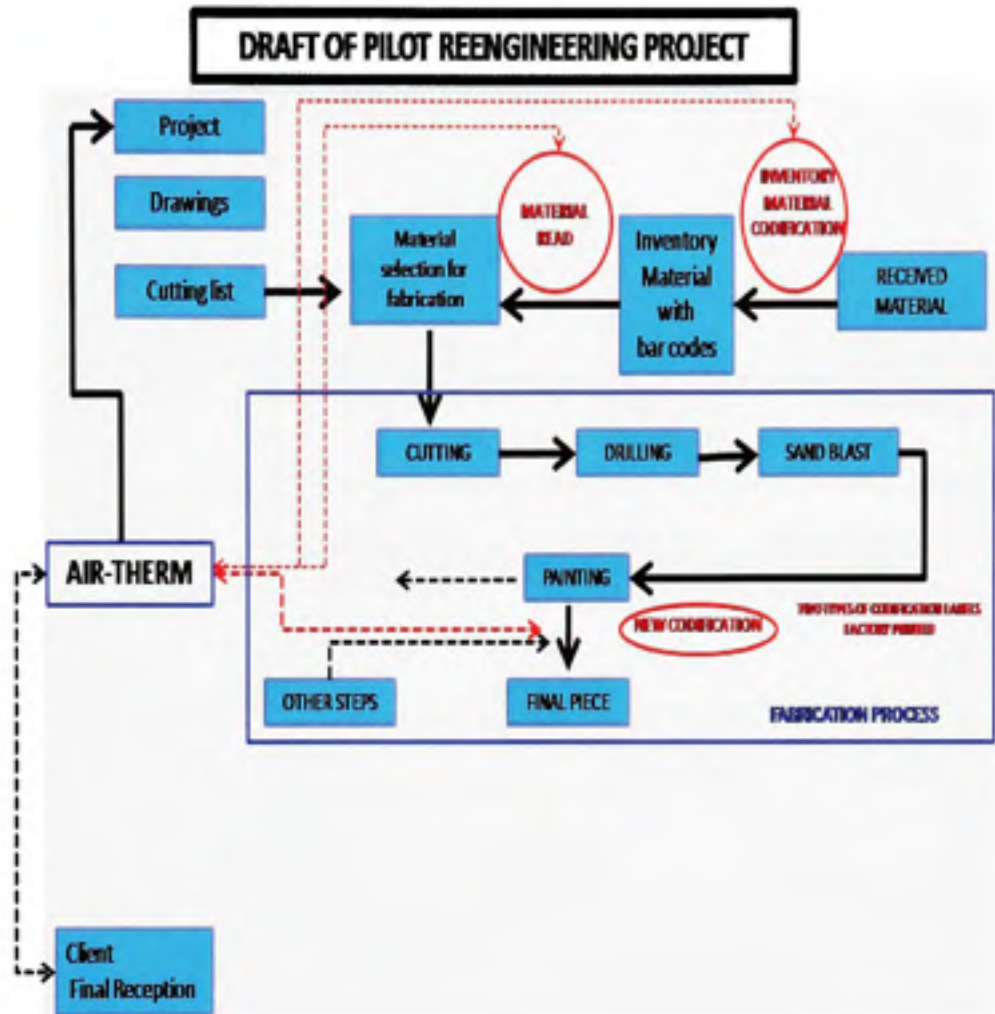

BY G. BAIKUNJI 2008

Figure 4.10 Pilot *Re-engineering Project 2*

The next step was to map out and design a new material flow for the structural steel and understand where the optimal points of codifying the parts would be easiest.

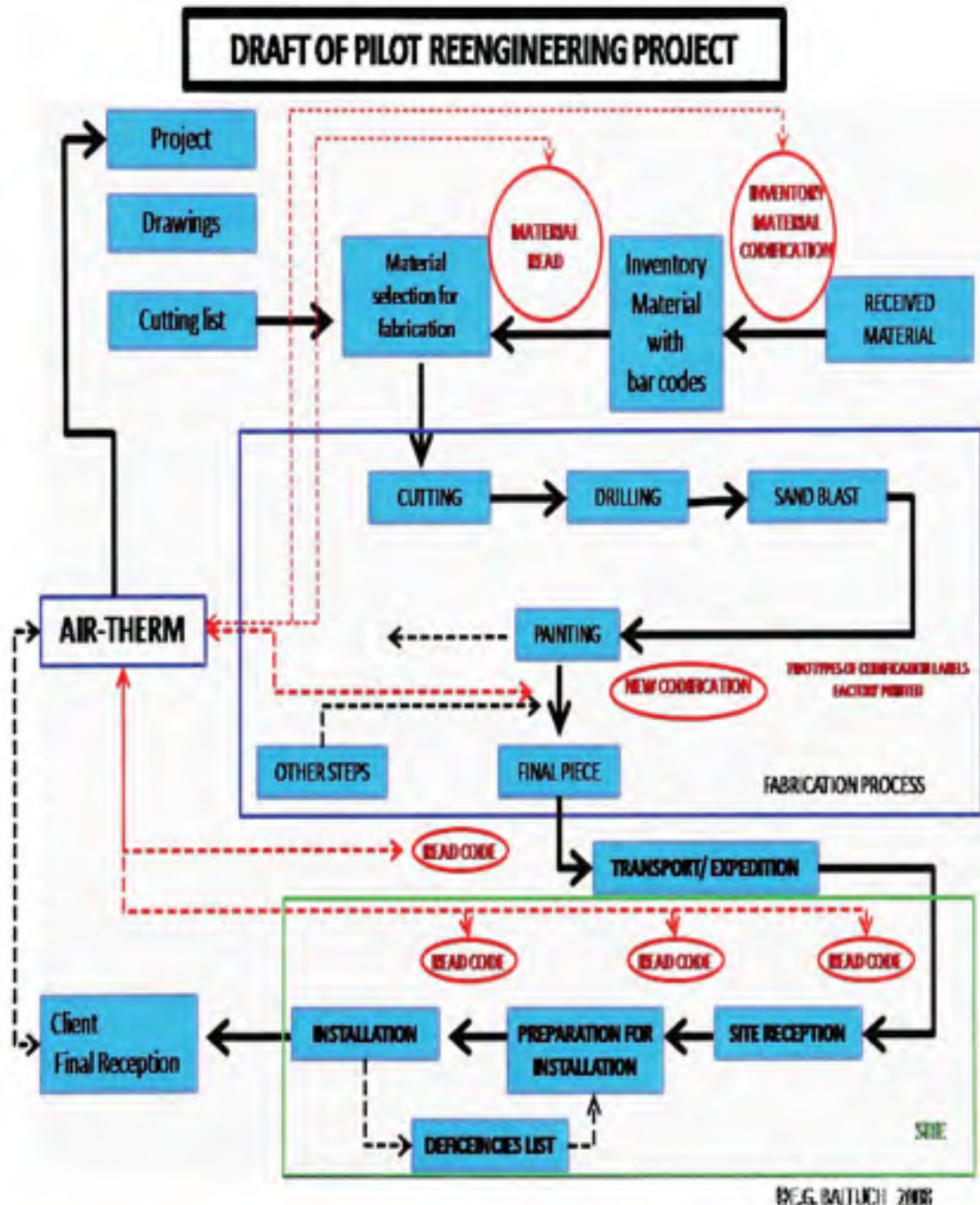

Figure 4.11 Pilot Re-engineering Project 3

Once a system of where the barcode would be read, the next goal was understanding the data flow requirements of the system. (Figure 4.11)



Figure 4.12 Pilot Re-engineering Project 4

Finally an integration of readings, marking and data flow was integrated into a single unitized data initiating, reading and relaying system. (Figure 4.12)

What was discovered was by applying a readable barcode, having established control points and having a simple system of information relaying in place, data mining was made possible

and all parties had live access to where the structural components were. The system proved relatively easy to establish and the results were immediately obvious.

The end goal can be seen on the following diagram (Figure 5.13)



Supply Chain Management: Process Engineering

- **Planning**
- **Implementing**
- **Controlling**

All Movement of:

- **Raw Materials: Goods, Documentation**
- **Work in Progress**
- **Inventory Control**
- **Installed Equipment**

Point of Origin  **Point Of Installation**

CE.G.BALTUCH 2008

Figure 5.13 Information Process

4.7 Summary of Pilot Program

The design engineer designated a barcode to each component and each drawing. When components were fabricated a printed decal was placed on the component and read. In that way all teams knew that the component was fabricated. When the part was to be expedited it was scanned. When the component was received, assembled, installed and inspected it was read. Examples of monitor readouts can be found in Appendix 3.

By assigning symbologies to all structural elements within the ventilators frames on all drawings and actual parts, engineering, fabrication and the construction team had a automated and transparent method of all knowing the identification, status and location of these parts. By bringing all three teams together to understand the specific needs of the other two teams, a higher level of remote collaboration was possible and obvious points of delay, friction and error were eliminated. The actual prototype was constructed only 300 metres from the fabricators which allowed all parties to be remote yet see and understand the purpose of the system and have the results immediately validated.

4.8 Roll Out

Due to the success of the pilot project and immediate realization of the potential earned value and process value to implementing a barcode inventory control system during the pilot phase, it was agreed to allow the experiment to be rolled out into a complete Gravity Ventilator project for a greenfield smelter.

Due to confidentiality agreements signed between Air-Therm, the consulting engineers involved in this project, the Aluminium company that paid for the systems and the process equipment technology providers, the place of this experiment must remain presented as company AA and country IS.

Due to the decision to conduct a pilot project prior to a full roll out it was easier to have a precise project definition, a more defined overall experiment design (including major component designs and defined subdivisions of responsibilities in project undertaking).

The basic barcode system would be rolled out in an identical manner with a number of discreet but important differences.

2 Dimensional Barcode



CE.G. BALTUCH 2008

Figure 4.14 *QR Code*

(Source: Denso Wave Corporation)

A decision was taken to evolve the experiment from 1 dimensional passive bar code to 2 dimensional passive barcode. The reason for this were:

2 dimensional barcode allowed for the use of mobile telephone's digital cameras to read the barcode (reducing the required equipment to be purchased) by the downloading of a java software patch that was available on line for no cost to the experiment.

2 dimensional codes would greatly increase the amount of data that could be held within the barcode itself. Therefore the barcode would not simply be a key to further information but could contain significantly more information as well to be used by an eventually enabled device that might not be connected to a web based database. As labeling methodology would remain that same there was in fact no need to purchase additional equipment other than more adhesive labeling material.

Significant work in the area of **Mobile Construction Supply Chain Management Using PDA and Barcodes** (2005) had been conducted by Tserng and Dzung in Taiwan and their logistical board and organigrams were studied and optimised in the implementation of this experiment. Like any experimental process, derivative effects and results become apparent. Because additional services could be implemented at basically the same cost, it was a rational decision to include them as part of the introduction of the barcode based inventory control system.

Project Portal

Once a system for inventory control was being developed for use on a full scale project it was immediately apparent that the inclusion of drawings, specifications, quality control, inspection reporting , expediting reporting could be made available to the field engineers and if fed back through the project organisation to corporate decision makers it would be

possible through this system to furnish live data mining capacity of all project characteristics. What this required was the creation of a middleware solution. Middleware is an application that provides services to support the communication between heterogeneous systems. In this case the least expensive and most efficient method of doing so was the utilisation of a MySQL database system and setting up the server system which would be web-based. Unquestionably for the implementation of a broader solution ERP solution providers such as Oracle and SAP offer much more evolved systems however at significantly greater cost and unnecessary for the scope of this experiment.

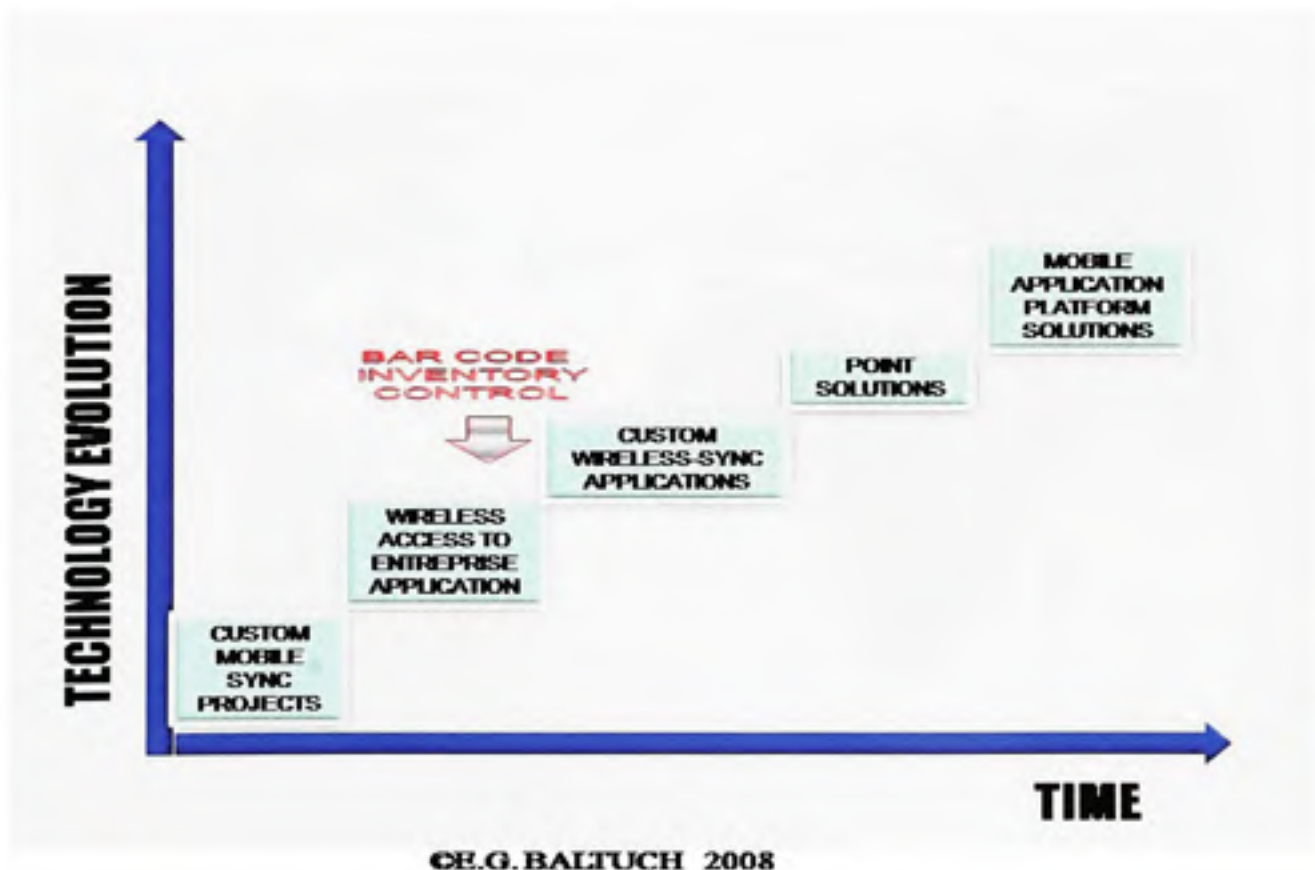

Figure 4.15 *Evolution of Wireless Technology*

This research project brought Air-Therm a solution that was the 2nd of a 5 step evolutionary process. In the construction sector, most enterprise have yet to consider the need for these steps which are prevalent in the aerospace, automotive and retail sectors.

This basic idea was driven by an understanding that once inventory control was being shared that many other information centers could be shared through a middleware system which would connect many different already existing corporate assets and allow an easier access to this information. The immediate discovery was that a freer sharing of information created a multi tier savings in time and money and that further innovations and optimization outside the scope of this study were produced simply by linking systems and allowing cross fields of collaboration. By sharing information it was easier to drive compliance and have teams adhere to the project's standards the accuracy of work carried out was increased and the deficiency lists were significantly reduced. Therefore reengineering costs were reduced at the design, fabrication and field levels.

MOBILE SUPPLY CHAIN CONTROL SYSTEM



DESIGN - BUILD - OPERATE - MAINTAIN

USPO PERFORM
 7750400J

GE.G. BALUCH 2008

Figure 4.16 Mobile Supply Chain

The goal of any engineered middleware solution should be to integrate knowledge, allow the orchestra of assets, allow for the potential analysis of data, and manage the information for the optimization of the project at hand. The key to utilizing a bar code based system is that all documents, and equipment carry a barcode therefore the entire work breakdown structure of the project can be entirely transparent from all conditions and authorized parties. Because the process occurs at the design phase and lives with the project (barcodes are not removed), during the entire lifecycle of the project the information can be utilized for process optimization (design, construct, operate, maintain).



Figure 4.17 *Project Lifecycle*

For the project's field engineers looking for a particular component or document is that they where more able to discover what was required and could more readily find it. They could see specifications (if there are revisions), drawings (if they were approved), knew where in production or transport a particular component is, and get this information without making six telephone calls across three continents and 14 time zones or having to search for paper

drawings. This will lead to the more rapid resolution of many time sapping technical and commercial micro issues best resolved in the field.



Figure 4.18 Project Lifecycle Construction Components

For the fabricating team, there was a more immediate understanding of what needed to be produced and when. If there were design changes for components there was a significant reduction in the wrong parts being fabricated potentially transported. This created savings in time and money at the plant level as well as an unstudied level of greater satisfaction and reduction of accusations generally directed at them.

For the engineering team it meant an easy methodology to transmit information to field and factory personnel and to receive a snapshot of the entire project that they could distill into executive summary for the project's decision makers. Because live information from macro to micro detail on a project can be delivered, business owners have the capacity to make better, more precise strategic decisions, thus saving time and money. The experiment when the additional capacities were added gave the potential to keep the entire project team on the same page 24/7 and in effect allow the entire supply chain to act in concert as a team.

Project execution: The additional task of designating a barcode (symbology) to every document and component and then applying these codes to each document and component proved almost seamless. As every drawing, specification and document is already registered both in paper form registers and in a MS Access database, adding a symbology simply meant that the document information could now be used and shared in a significantly more available and logical manner. Both the factory team and jobsite team could see what had been designed, approved, and authorised for fabrication.

All components were manufactured in the same manner, by the same personnel, however parts that might be in greater need or might not be needed could now be allotted a different priority, rather than being produced in order to follow a list made months before. Both engineering and jobsite could see what inventory was in house, what was being produced, and based on lead times could estimate when goods would be shipped.

Because goods were scanned after being fabricated, and then scanned when loaded into marine containers for shipping, the entire project team was aware what was shipped and when it was shipped. This meant that when goods were received, the jobsite already was aware what to expect. This greatly assisted them in the de-containerisation process. Part of the challenge of the control test was dealing with some of the frustration of the team that did not have this information and felt that this was a great handicap.

Better inventory control at the jobsite meant that parts were more easily found and worked could quickly determine what they were and where they were required. Significantly less calls from jobsite to engineering were logged as the jobsite team were more likely to have the inventory which they required and secondly could solve most queries through the automated system.

Air-Therm is paid by a progressive method (for milestones of work carried out). The client requests that 7 days prior to issuing their progressive billing that a provision statement of planned billing is issued with proof of the works carried out. The barcode system was a very

well targeted tool for immediately being able to demonstrate exactly what engineering had been approved, what raw material had been procured, exact quantities that had been fabricated and so on up to client hand over of sections of installed equipment.

From an accounting perspective, the barcode system allowed the accounting personnel at the head office to be much more aware of what was to be invoiced. This actually moved forward billing by at least 30 days, therefore allowing Air-Therm to be paid early, and improve their bottom line.

Because all project modeling by Air-Therm is now carried out in a 3 dimension model (as seen in figure 4.19) the information garnered through inventory control and live mobile reporting can potentially immediately be seen on the 3 dimensional model for 4 dimensional (time) and 5 dimensional (cost) modeling and earned value assessment of the project conditions.

3D MODELING



CE.G.BALUCH 2008

Figure 4.19 *3 Dimensional model*



Figure 4.20 *Component being scanned*

Once a component or a drawing of a component is scanned, the jobsite engineer's handset will indicate to him what the component is. He has live data as project engineering, specifications, whether the parts required have been procured, where the parts are in the drawing review process, whether (and where) they are in inventory, if they have been inspected and expedited, if they are on site and if so where.

STATUS MONITOR

HPM STATUS MONITOR			
STEP	N	Y	DATE
PROJECT ENG.			
PROJECT SPEC.			
LOT PROCURED			
ENG. REVIEW			
SUPPLIER PROC.			
SUPPLIER INVENT			
SUPPLIER FAB			
INSPECTED			
EXPORTED			
SITE INVENTORY			
SITE ASSEMBLY			
SITE INSTALLATION			
HP APPROVED			

GE.G. BALTUCH 2008

Figure 4.21 *Status Monitor*

This proved to save a great deal of time and money as the jobsite engineer is able to be significantly more autonomous and waste significantly less time searching for information and more time executing key engineering tasks. A significant reduction in jobsite traveling occurred as answers were more easily found. Because less fossil fuels were consumed (less gasoline) and paper printed costs were reduced and potentially the project was conducted in a more environmentally conscious manner.

PLM: Business Process Key Deliverable

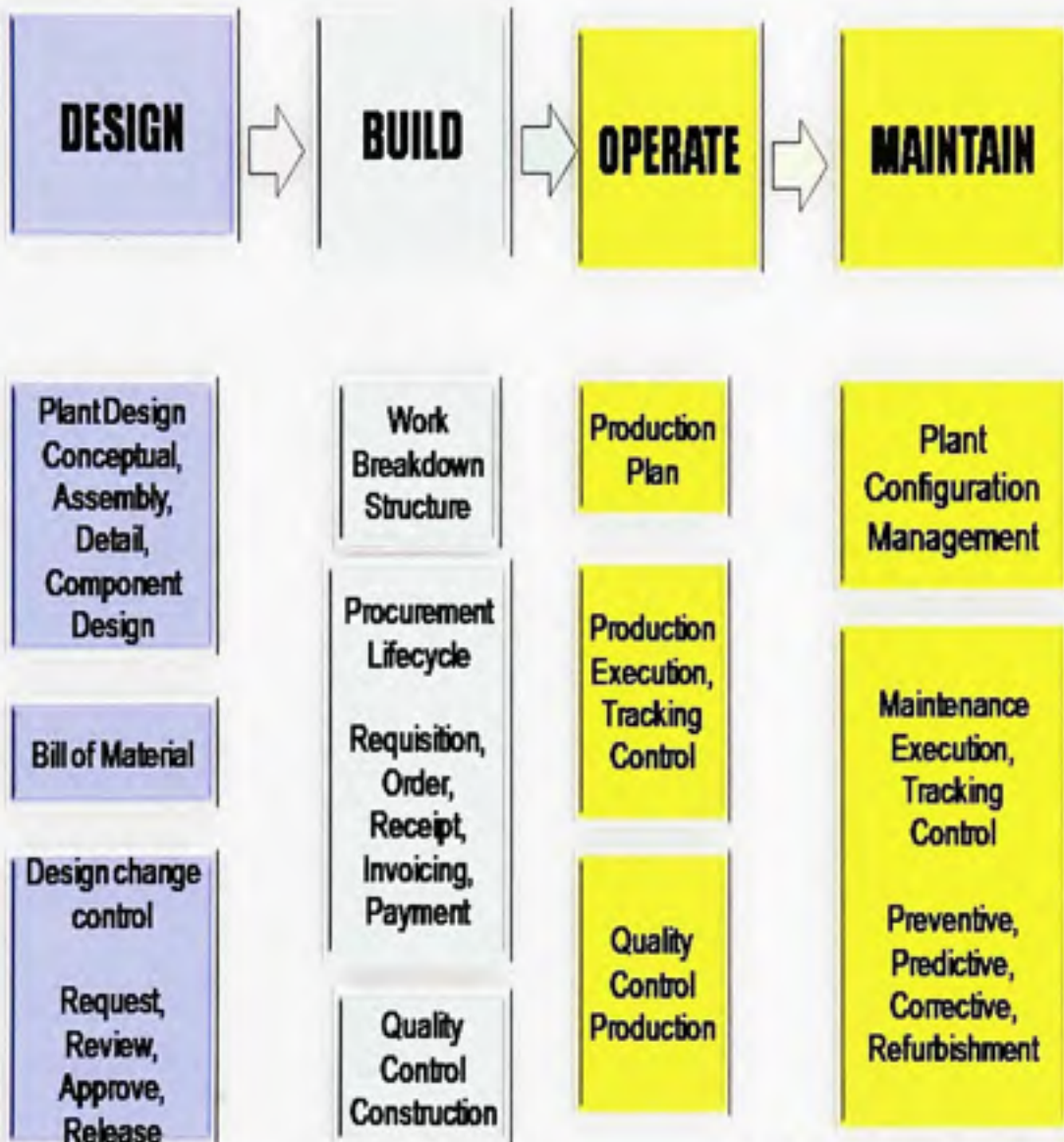

©E.G.BALTUCH 2008

Figure 4.22 Project lifecycle management deliverables

Once all key deliverables (documentation and material) are designated with a barcode symbology, which is readable and understood by the integrated system, the potential for this data to be utilized for different applications is present through a projects complete lifecycle (Figures 4.22).

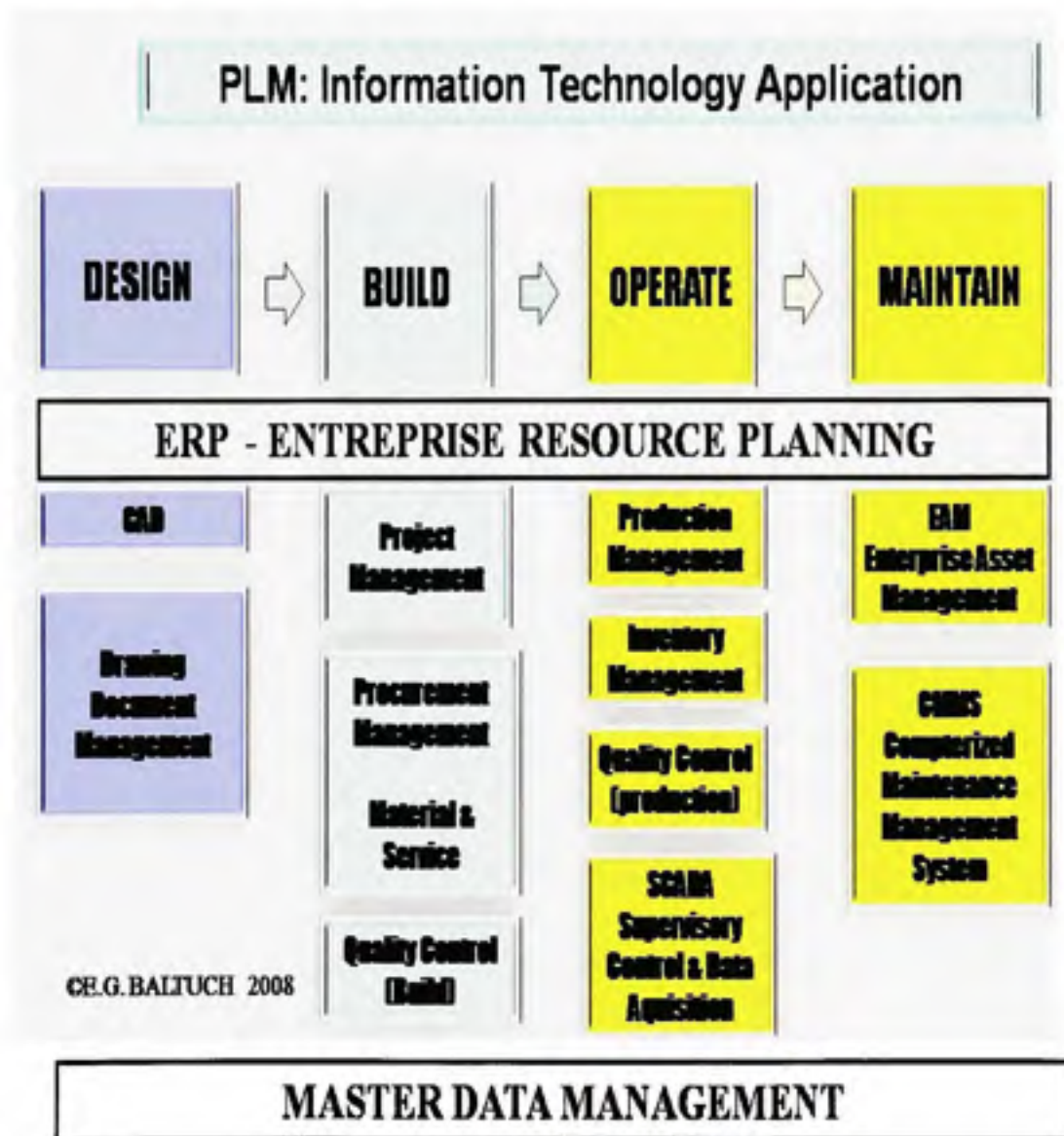

Figure 4.23 Project Lifecycle Management Link to ERP

Although initially this system was designed solely for the construction management of this research project, it became evident that by allowing design, project management, fabrication and construction to collaborate a complete project lifecycle management tool was being created that could be later integrated into the end users enterprise resource planning software (Figure 4.23).

4.9 Summary

The problem that this research project attempts to resolve is rendering inventory control system more efficient (could a more efficient inventory control method save time and money). The hypothesis is that developing and introducing a barcode construction management system will carry out that they work out faster at a lower cost while maintaining the same (or better) quality specification.

As a first step the project audited what was in place and found little else other than willing participant and a corporate partner willing to minimally invest in the required experiment. Details of the cost of this pilot project were described.

Secondly, a pilot project was conducted with only the structural steel elements being bar-coded and tested. Details of how this process took place are described. The pilot project proved successful, and clearly validated the hypothesis of the experimental applied research and however a roll out on a complete program was agreed to in order to further demonstrate the system. During the roll out the project was divided in half, to be able to compare the new system with the tradition methodology.

To make sure that redundancy was in place, during the pilot and roll out, all parts were marked in the traditional manner as well. The mobile handsets developed by this project and utilized by the jobsite team were explained.

CHAPTER 5

OBSERVATIONS OF IMPLEMENTATION

5.1 Observations

By utilizing the barcode based multi-tiered inventory control system a project that had a planned schedule of 10 working months (300 calendar days) (design, fabrication, jobsite work, rectification of deficiencies) was completed in 242 days. It should be noted that the team working with traditional methods completed their project in 270 days (design, fabrication, jobsite work, rectification of deficiencies). Some of the difference which can be explained in part due to the competitive nature of the experiment. The section of ventilators, designed, inventoried, expedited, transported, assembled and installed utilizing the described barcode based system, was constructed 22 % faster (man hours

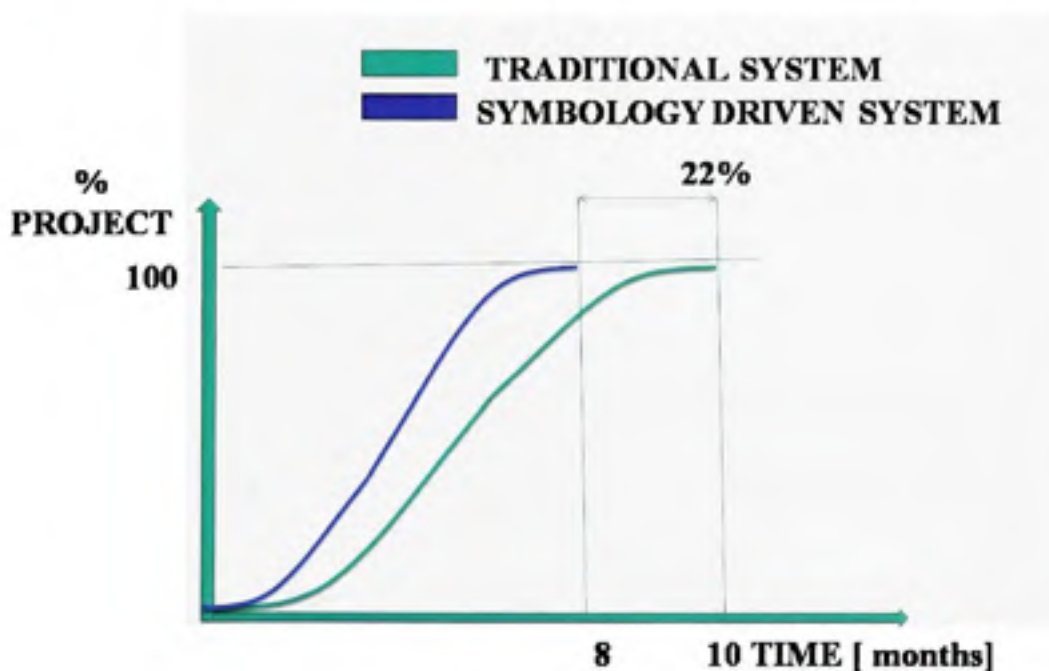

CE.G. BALZUCH 2008

Figure 5.1 *Timeline*

and with a cost that was 24% lower in terms of cost out side of material (material costs were essentially equal for both types of construction).

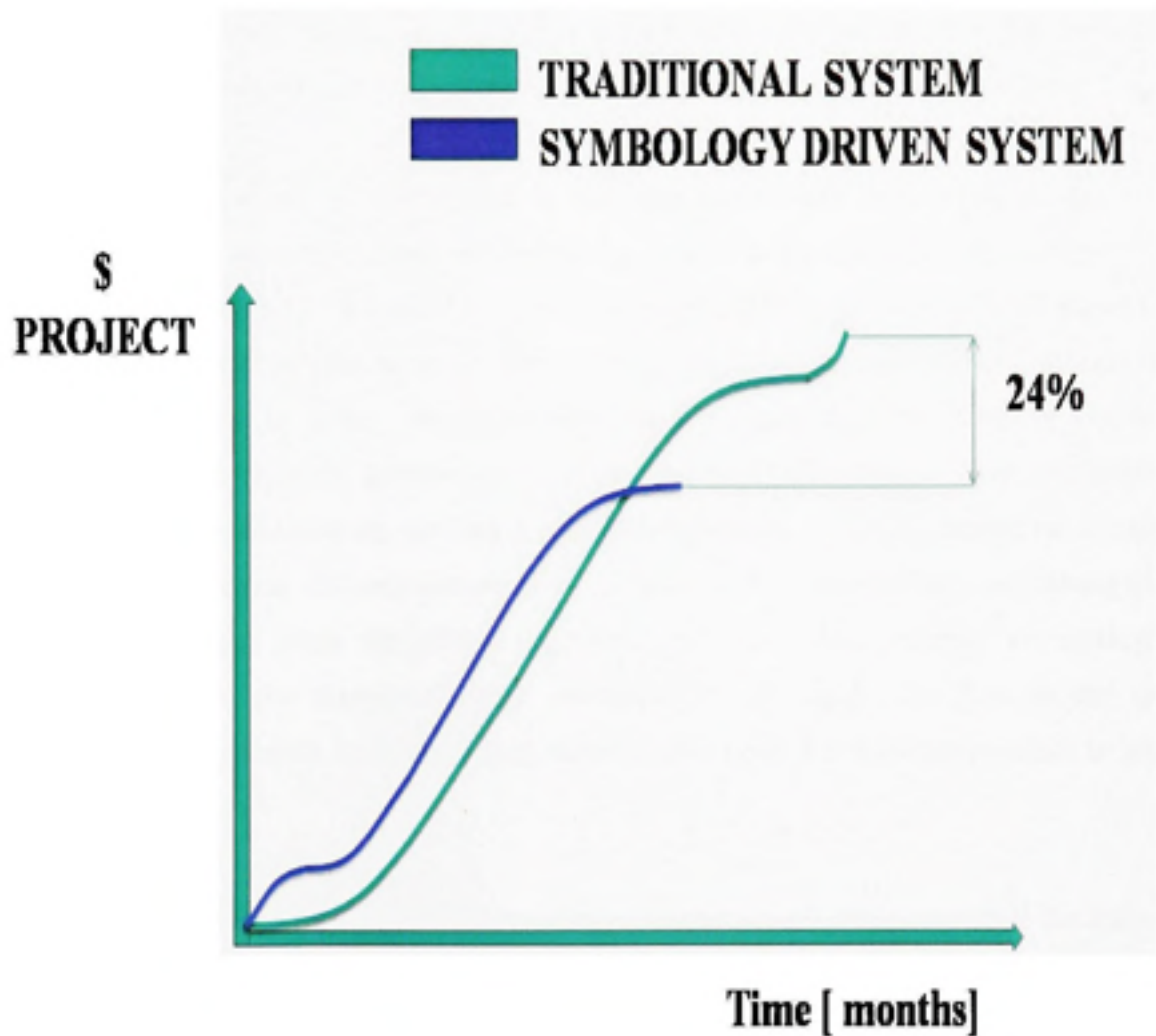

©E.G.BALTUCH 2008

Figure 5.2 *Cost Comparisons*

Engineering and fabrication occurred in the Montreal area while actual construction was executed at a remote location, which required 4 weeks of shipping to have any equipment arrive, 4 times away and 16 hours of difficult travel to physically get to.

The goal was to utilize the company's existing capacities (and constraints) in concert with the new system to see whether the half of a project where the process was applied would demonstrate that barcode would improve the performance in a quantifiable manner.

Based on the experiments carried out, it has been ascertained that a symbology based inventory control system is capable of allowing access to all specifications pertinent to a particular part through all phases of a project's life cycle (Design-Build-Operate-Maintain), and will allow both remote access to this information through a middleware system and direct information at point of symbology reading capture. This will, if correctly implemented and utilized, greatly improve the ability of the project field construction personnel, project engineering and eventually plant operation to readily access the required information. The more efficient data mining can have an influence on decision making at all levels of a project, from the jobsite engineer, the fabrication manager attempting to prioritize projects, the accounting team attempting to manage cash flow in the most efficient manner possible to the company director who needs the best data possible to make important decisions.

The time lost in data mining can be very costly and the project discovered that the barcode based construction management system allowed live data mining a new level of collaboration between all parties.

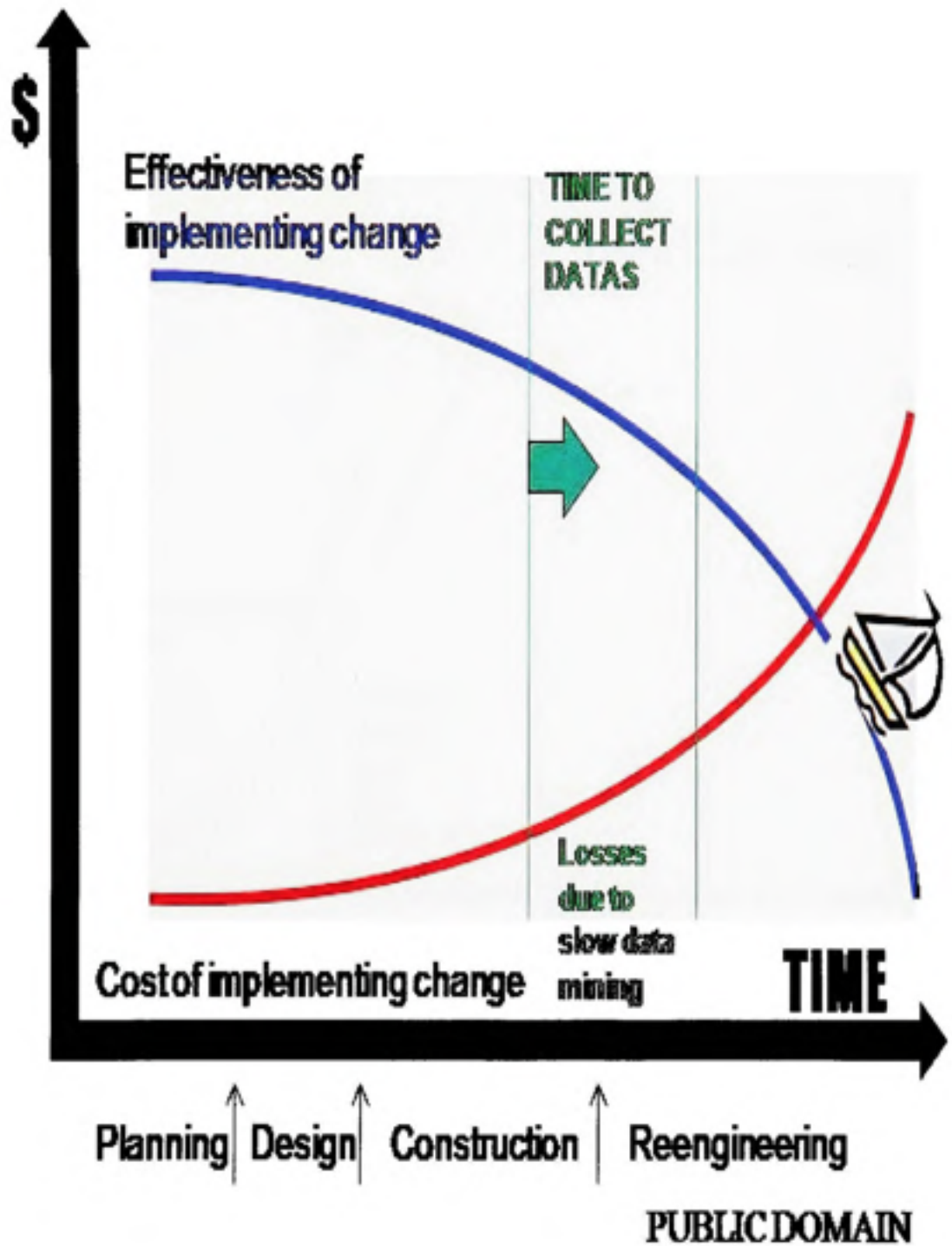
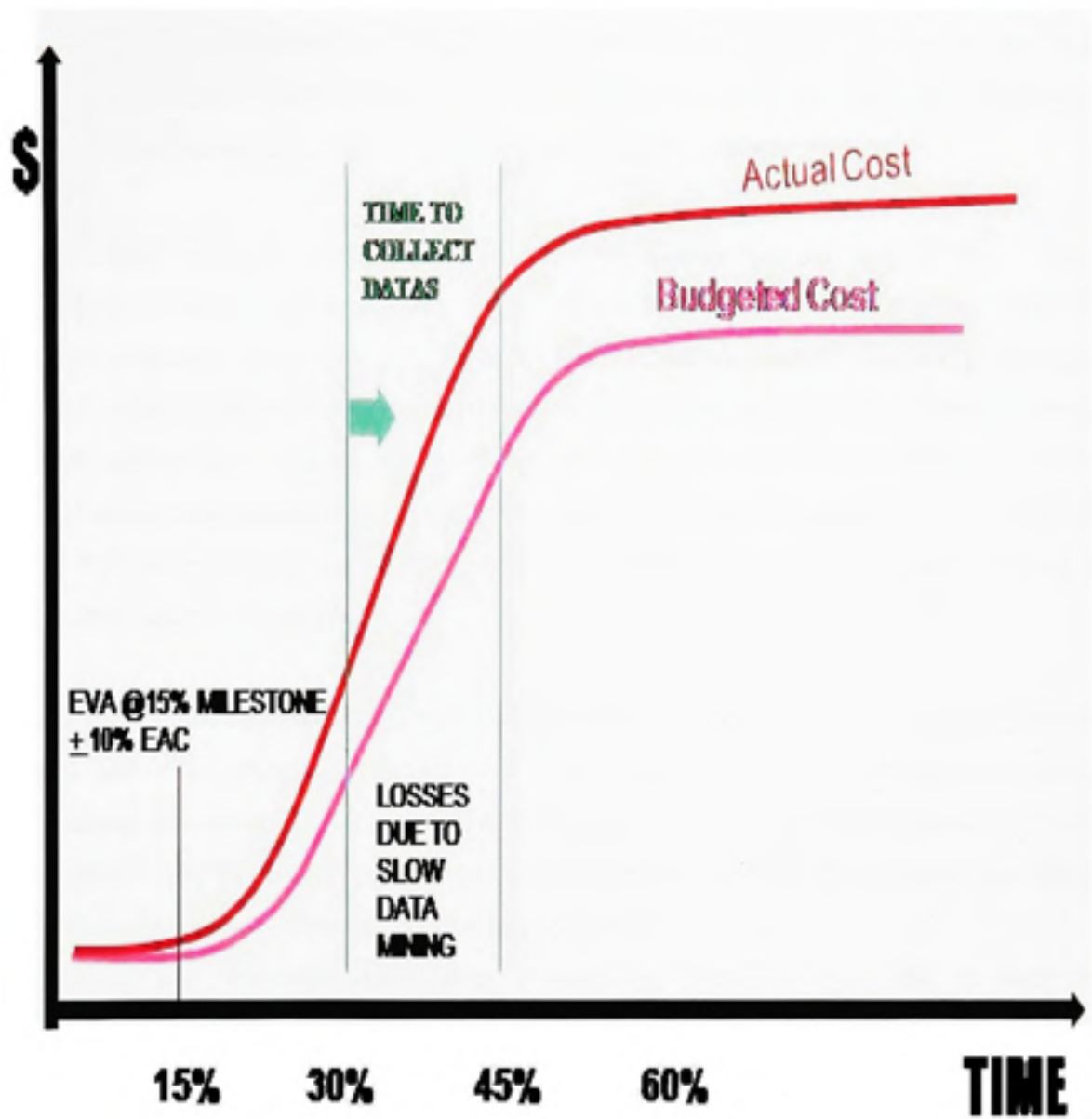

Figure 5.3 Cost of time delay in data mining



% PROJECT COMPLETION

PUBLIC DOMAIN

Figure 5.4 *Earned value analysis data mining*

The barcode based construction management system allowed direction to have a very clear picture early on as to what their project's earned value was and therefore was much more accurate at predicting the project outcome than a traditional model is.

Because Air-Therm is a privately held corporation that has no requirement to issue statements of income, profit or loss a statement of gain and has a number of collective bargaining agreements in place with a number of trade unions, system audit was pronounced in terms of percentages. In fact once there was a corporate realization of just how much wastage was present in the traditional system and an internal audit was conducted to verify that the saving demonstrated in time and money were accurate, there was a strong desire to make this entire project confidential and insist that further guidelines were in place to render the conclusions proprietary.

The section of ventilators which were assembled and installed utilizing the experimental system had a deficiency list which was 80% reduced from the other team. Because information was gathering more accurately during the project, this team was able to meet the project's quality control and inventory control manual specification much more easily and which significantly less required further corrections.

This meant that with this information at hand Air-Therm is more able to seek out international business and be prepared to be more competitive while still maintaining sufficient margins to remain competitive from their current based of operation.

The hypothesis that the use of a multi tier barcode system based on a convergence of now readily available technologies is possible and will allow for the better, faster and less costly design, supply and installation of industrial gravity ventilators was proven by this quantitative experiment.

Because of the application of this experiment Air-Therm was able to have actual costs arrive significantly below budgeted costs (based on traditional system) and therefore achieve significantly optimized earned value for the entire project.

The information from the barcode system could be inputted into the 3 dimension model which allowed for a rapid visual understanding of the progressive milestones of the project.



©E.G.BALTUCH 2008

Figure 5.5 3 D modeling of project variables

Because the time of every scan was recorded by the system, it is possible to create 4 dimension models based on this critical information.



CE.G.BALTUCH 2008

Figure 5.6 4 D modeling of project variables

The final element which Air-Therm was less interested in sharing and more interested in studying was the fact that once a complete 3 and 4 dimension model of the project existed and every element could have a cost subscribed to it, it became possible to model the entire project in 5 dimensions. Information from this model remains confidential.

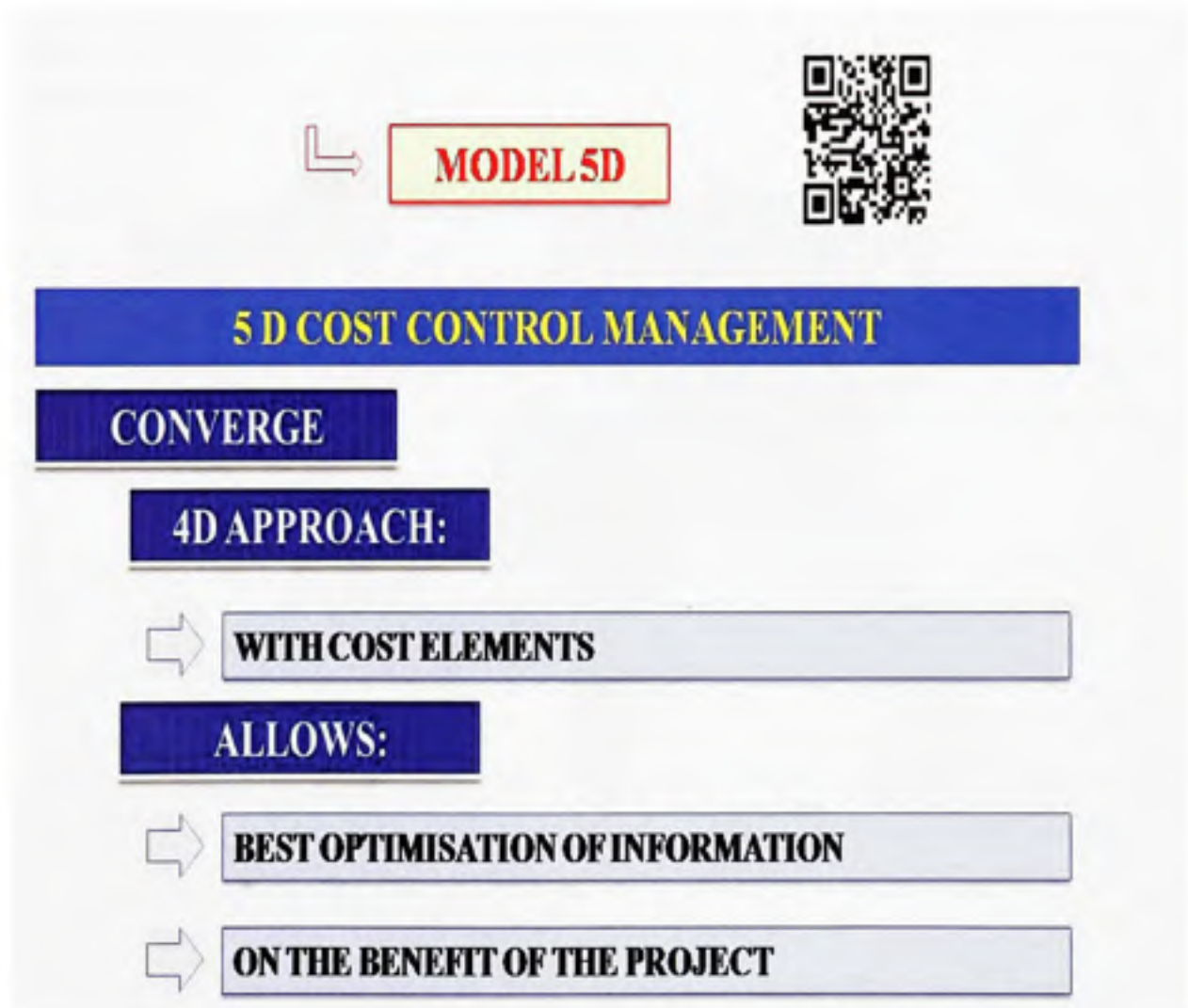

CE.G.BALTUCH 2008

Figure 5.7 5 D modeling of project variables

Results beyond the scope of this study.

By applying a barcode or symbology to every component of a gravity ventilator system, the ISO traceability standards would have been able to be implemented. Therefore any failure of material or equipment could be traced back to the base metal and the origins of the fabrication process. Even though this information may be less important in the construction of gravity ventilators, such information may be important if applied to the construction of a nuclear reactor or hydro electric facility where information about critical components may be more important.

Because the system selected for study was a passive system, which required manual scanning certain gains could not be realized, however if a fully automated, active symbology system, such as RFID, Bluetooth or NFC was implemented the potential for machine to machine (m2m) automation and decision making, and once in operation the ability of component to be able to communicate maintenance and repair needs could be foreseen quite easily.

5.2 Summary of observations

- The hypothesis was validated.
- By utilizing the barcode-based construction management tool substantial savings on time and money were realized, while maintain or improving the specified quality levels.
- A significantly higher level of project control was put in place with a live data-mining tool that assisted all levels of project management.
- Derivative to this process was the discovery that this convergence of technology allowed for a higher level of jobsite, engineering office, fabrication collaboration.

- The barcode based construction management system has utility beyond the design and construction phase and may prove to be of value to the operation and maintenance lifecycle phases as well.
- By using this innovative tool, the project proved to lessen their environmental impact and carry out there work in a 'greener' manner.

CHAPTER 6

CONCLUSION AND DISCUSSION

6.1 Conclusion

The application of the experimental barcode based inventory control system saved the project time, money and produced a project with less remaining deficiencies. By automating certain tasks and allowing different teams to communicate, collaborate towards a common goal, optimized results are possible. By making an initial investment in time and capital, a significant gain in the end result was made. As has been demonstrated elsewhere, decisions made early on in a project are more likely to have a more significant effect on the final outcome of any project.

A number of derivative benefits were discovered, such as traceability, the potential to implement the basis of a computerized maintenance management system after the construction management phase is completed, and the widespread applicability of this technology to other industries.

While the decision to implement planning and inventory controls is important, it is even more important to utilize these controls once they are in place. "Plan you project...Execute according to your plan."

6.2 Strategic positioning and viability of particular innovations.

The market reality of the aluminium smelter construction sector is that six major new aluminium smelter construction in the next 36 months major smelters are to built. The location of these smelter will be in low cost construction location where the convergence of available excess energy, deep water port facilities, and governments amenable to the importation of low cost labour and a goal of very low total installed costs. Appendix 4 is a

gravity ventilator that has now been developed with this barcode construction management system integrated into the design.

These projects all require Air-Therm to be innovative in their design and construction approach if they are to be globally competitive. The other competitors are aware of this fact as well and are hard at work establishing design and methods of construction that prove to be the successful model.

Air-Therm's strategy is to demonstrate to the market that it is primarily an engineering firm that fabricates ventilators, as opposed to our competition which tend to be metal fabricators with engineers. In general the adjudicators for contract award are engineers and our approach has been successful.

Air-Therm has been the market leader in the North American market since the early 1980s, due to winning a number of projects, which pushed out other players in the North American Market.

As of 2004 Air-Therm has emerged as the market leader in the global market.

Air-Therm is well placed to provide a superior level of innovation at a price level, which is as close as possible to the next cheapest price on the global market. Air-Therm innovates, out of interest more than it has to, to be competitive in this particular market (beyond "just in time technology").

A concerted effort should be made to further develop these technologies and find markets for these innovations with significantly wider applications.



Figure 6.1 *Innovation nexus*

In a competitive market the goal is to be the lowest price by the least amount possible amount, therefore hoping to have the highest possible profit margin.

Innovation, in and of itself, is a cost which must stand alone to demonstrate it's ability to sell the product (make it demonstrably better) and then make it cheaper to produce. Understandably, it only has to be better and cheaper than the competition. In the simple confines of Static Roof ventilators, with the introduction of the barcode driven inventory control system, Air-Therm has no need to further accelerate it's rate of innovation. This can be understood by the chart below.

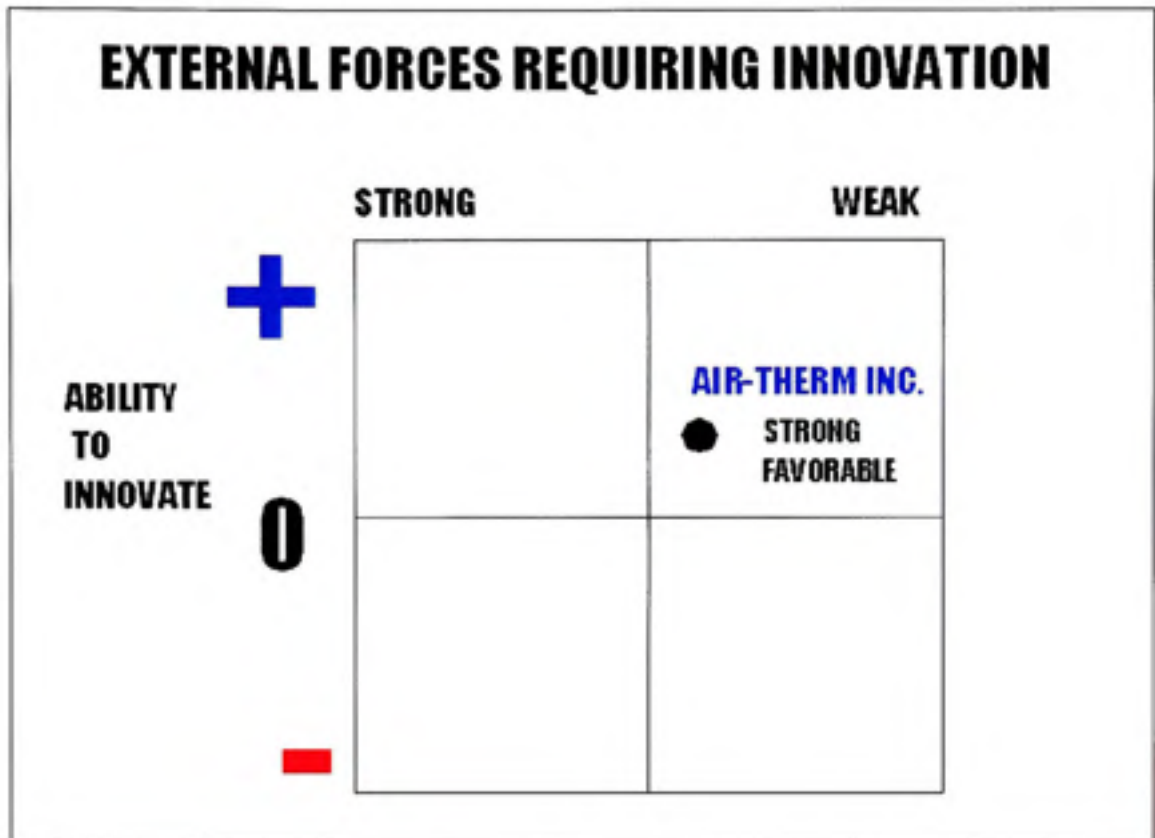

Figure 6.2 Forces of change

For Air-Therm to be motivated to continue research and development of a barcode driven inventory control system they may have promise to continue development toward a fully integrate mobile barcode driven supply chain management system there must be a strategy to apply this technology to other applications.

Due to time and capital constraints other symbology type technologies were not implemented: active technologies such as radio frequency identification and near field communication may have far reaching effects to further improve project performance.

6.3 Industrial Implications

This experiment's barcode based inventory control system if seen as a mobile supply chain control system has the potential to replace significant portions of the work being carried out by consulting groups by effectively allowing a significantly smaller group to control, leverage and direct project. Further because of the cost and time savings seen during this experiment, even if cost saving on other scope of work are not as significant, on a 2 or 3 billion dollar project the ramifications would be there.

6.4 Future Research

An area of future research would be to test this hypothesis on a larger scope project or converge it with other technologies such as VOiP and assess the effects. Significant advances in other fields of technologies will occur shortly and the converging of these new undiscovered technologies would make for dynamic and interesting discoveries in the years to come.

On a macro level, far reaching observations could be made about the reasons for such uses of technologically innovative systems and the uses of manpower in particular sectors of many industries. This will be left for others to consider and study. On a micro level, by utilizing PDA / pocket computers, which are both web and GPS enabled, and like many computer devices retain a utilization history that may have given the research project, deep and detailed insight into the personal work habits of all involved in the study.

This information has in no way been researched, observed, recorded, retained or utilized to the potential prejudice of engineers or workers involved in this project. However it should be noted from an engineering standpoint that this methodology could be utilized, once ethically vetted for a plethora of other remarkable studies.

The industrial gravity ventilator design as such is outside the parameter of this research. Even though substantial information about the design, transport, pre assembly modularization and installation of the gravity ventilators were derived from this study, this was outside the specification of the research study and therefore was given to the corporate sponsor outside the frame of this research.

APPENDIX I

PHOTOS OF AIR-THERM GRAVITY VENTILATOR PROJECTS

- Cross section of Air-Therm ventilator on smelter potline

- Aerial View of typical integrated aluminium smelter with Air-Therm gravity ventilator on roof. A portion of this project was part of the pilot study for this experiment.

- Cross section CFD of smelter with ventilator.

- 4 Photo montage detailing part of the steel fabrication process.

- Photo of the prototype utilized prior to the pilot study.

- 5 Photo montage of ventilator assembly process.

- Results of installation as seen from space.



Cross section of aluminium smelter
showing structural steel erection of
Air-Therm gravity ventilator



Arial View of aluminium smelter with
Air-Therm gravity ventilator installed

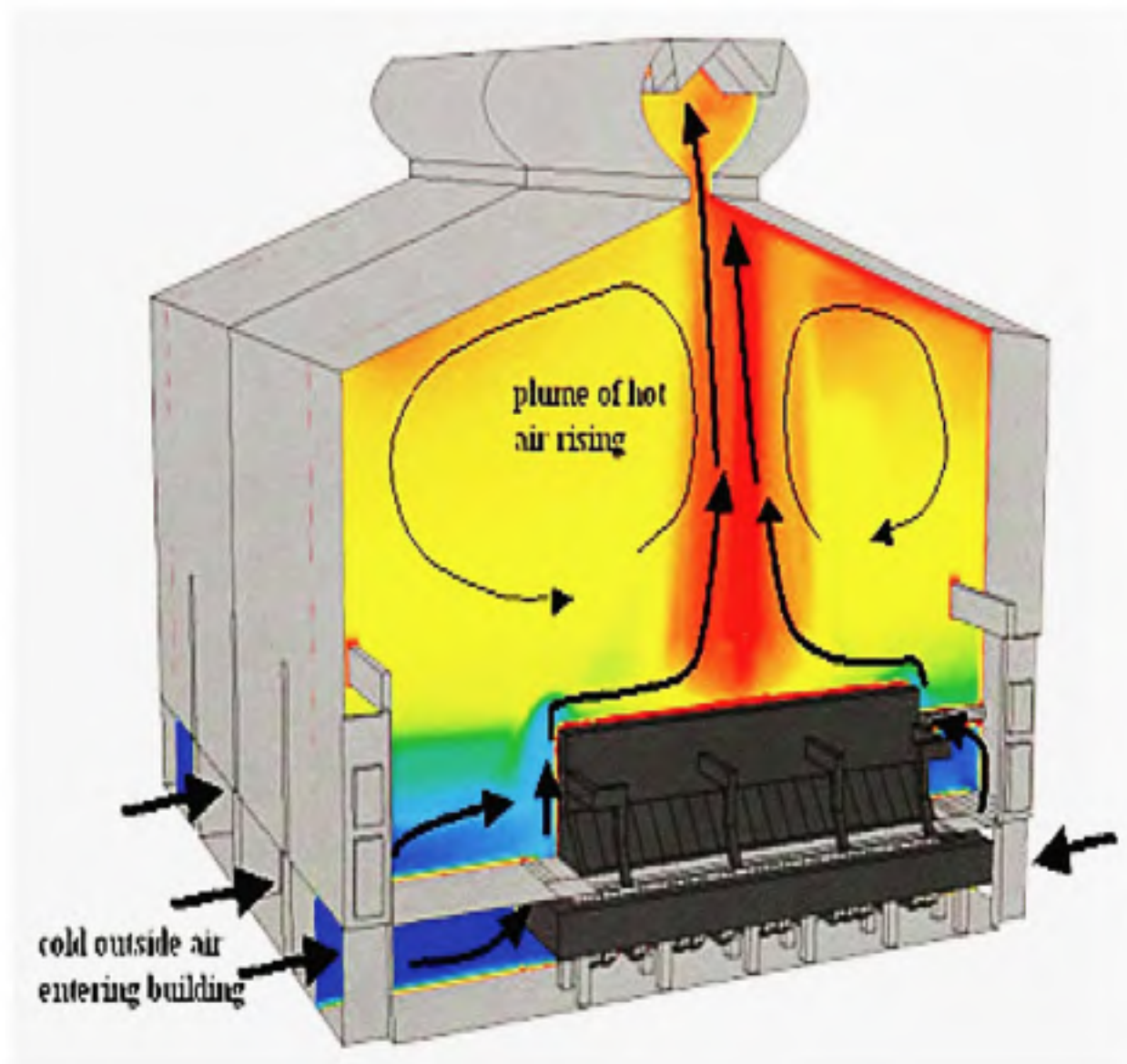

CFD cross section of aluminium smelter showing heat dispersion modeling of reduction cell potroom utilizing Air-Therm gravity ventilator



Air-Therm structural works 40 foot lengths of steel prior to cutting and punching process



Frame components at Air-Therm works



Frame components post fabrication at Air-Therm works
scanned and approved for transport to jobsite



Frame components post fabrication at Air-Therm works scanned and approved being loaded for transport to jobsite



Prototype unit utilized in the pilot program for this research project



Air-Therm ventilator installed
on potline building



Air-Therm ventilator module being installed on potline building



Air-Therm ventilator module being assembled on the ground: due to barcode system module utilizing this system were assembled faster and utilizing less labour



Air-Therm ventilator ground assembled module lifted into place: each module was designated with a macro symbology which would allow all other codes to be stored for that section of ventilator

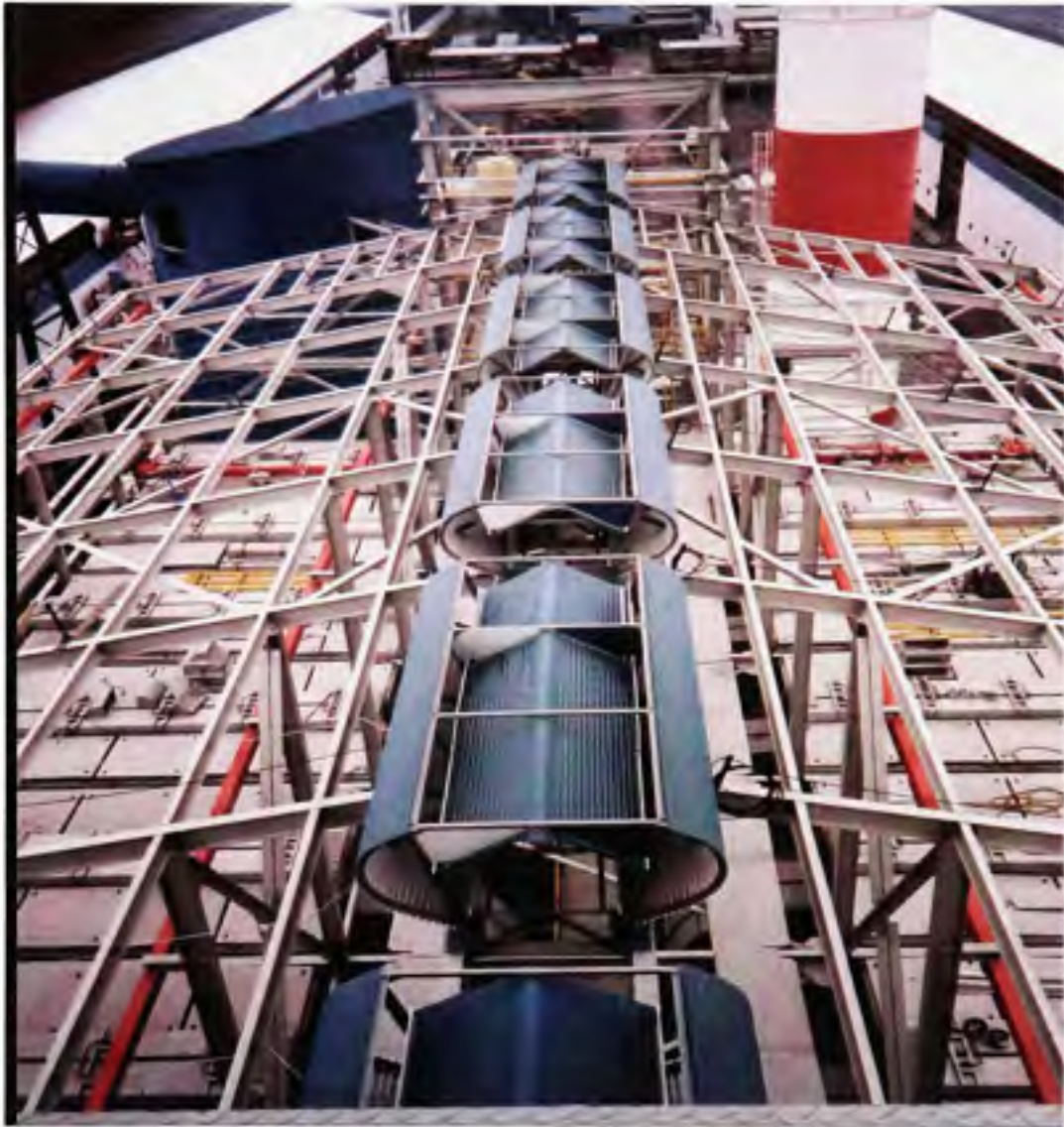

Air-Therm ventilator ground assembled module installed on building structure of smelter gas treatment center. Although module appear identical, due to variances in building steel structure each module has to be installed in a designated space. By utilising a code system both the engineering team and the erection crew had a basis for correct placement and not relying on more traditional methods a rapid component installation.

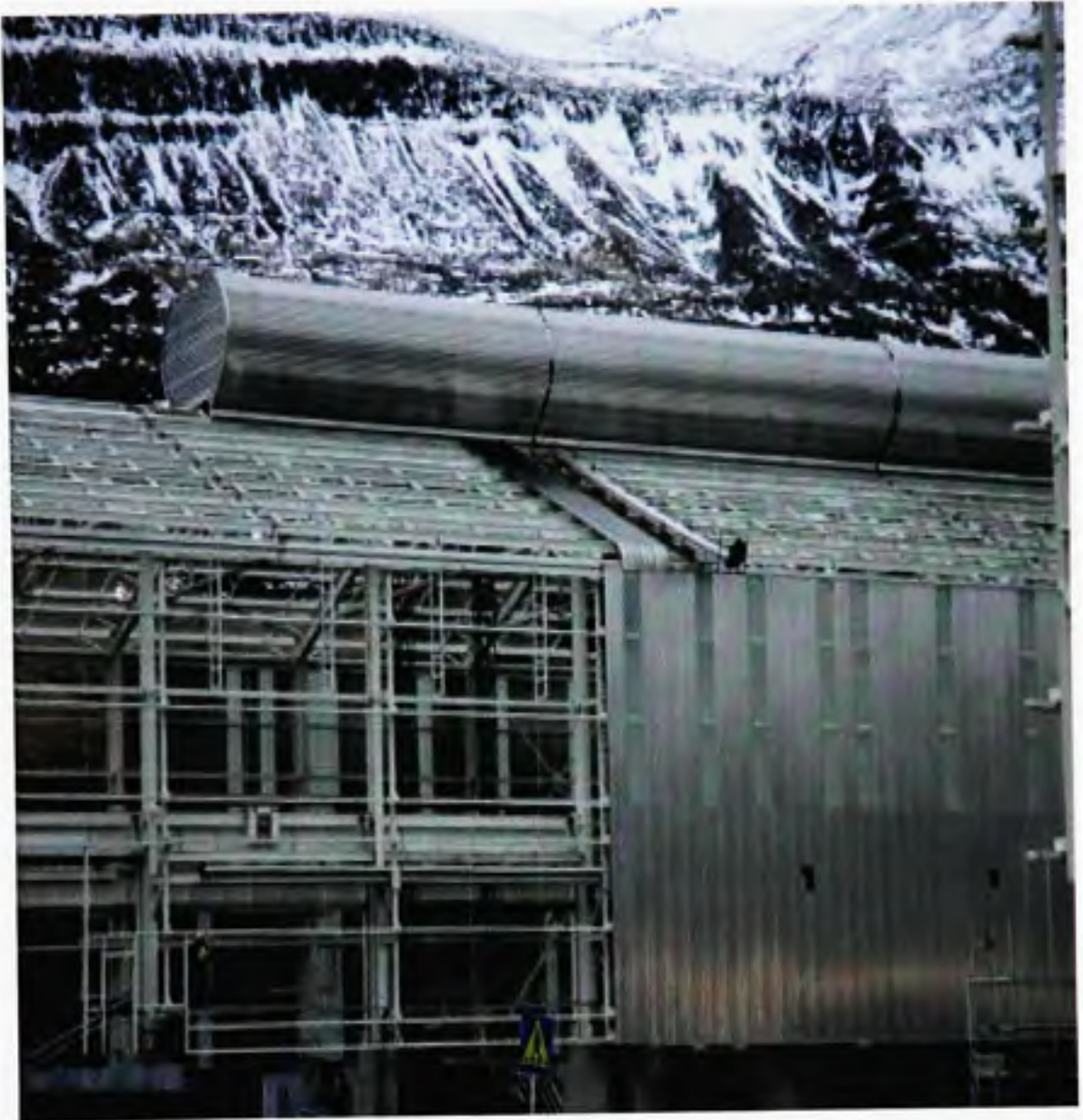

Air-Therm ventilator on potline building

Due to extreme location of the project construction crews were at a premium and the cost of labour was extremely high.



Air-Therm ventilator on potline building

Due to extreme weather conditions proper planning and inventory control allowed construction crews to optimize the effort which they were able to execute.

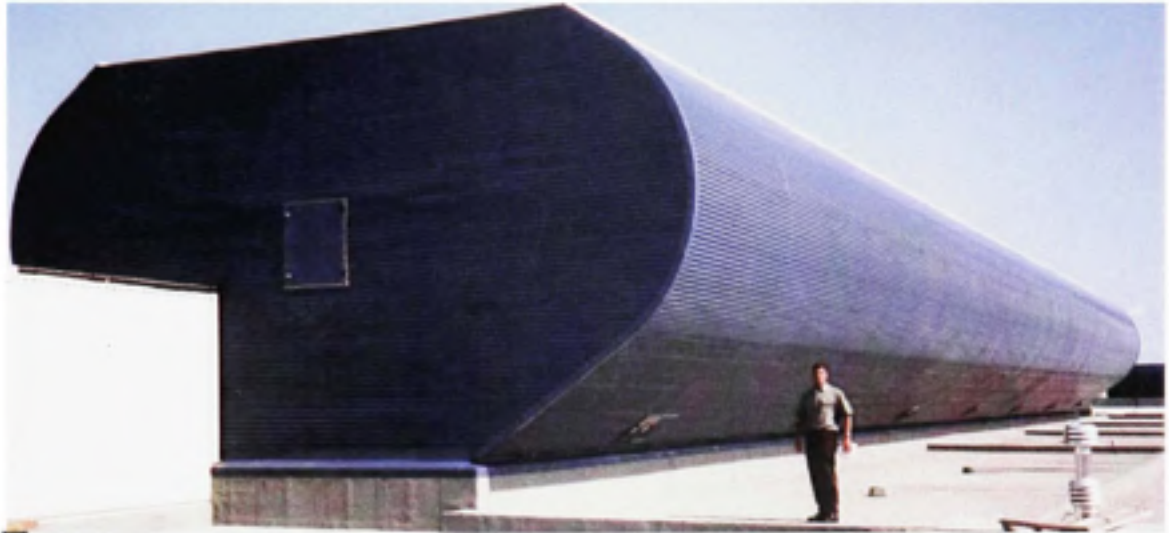

Utilizing the author as tool to understand ventilator scale size.

This is a 5,5 metre throat ventilator installed on an aluminium smelter sow caster due to placement in the middle of a complicated construction site, all lifting was carried by Bell 222 helicopter in 110 lifts in a single day.

Preparation for the planning and inventory control required 6 weeks of planning to successfully execute this operation.



Air-Therm installation utilizing helicopter as lifting tool proper planning and utilization of innovative management techniques can make the difference between a well executed and profitable operation and a complete disaster.



A construction crew of 4 men inside an Air-Therm gravity ventilator. A cost of approx. \$70.00 per man-hour the need for proper planning and management tool has been shown to significantly shorten work schedule, reduce cost, and improve quality.



Anode baking furnace building of aluminium smelter prior to installation of Air-Therm inlet louvres.

A final survey of all opening is conducted to ensure more efficient and proper installation of inlet louvre components.



Typical Air-Therm louvre section louvres for aluminium smelters are fabricated in 6060T5 aluminium extrusions at locations remote to project locations. ensuring proper construction management is essential to ensuring profitability of the venture



Air-Therm gravity ventilator
on roof of smelter potline in south eastern Queensland

As seen from space on Google Earth.





APPENDIX II

SAMPLE DRAWINGS AND INVENTORY CONTROL SHEETS

Sample drawings and inventory control list

 GRAVITEC	<h1 style="color: red;">CAP</h1>	FABRICATION <h1 style="color: red;">5XA</h1>	
ITEM	CODE	DESCRIPTION TYPE CAP	QTE
1		C	124
2		CE1	2
3		CE2	2
PROJECT <h2 style="color: red;">5XA</h2>		TITLE <h2 style="color: black;">CAP - CODES</h2>	
		AT CODE: P2734	
		DRAWN BY : D.A.	VERIFIED BY : L.V.
		APPROVED BY : E.G.B.	DATE: 07-01-26
		DRWG NUM: 06-5481-1	REV: 00
		 www.air-therm.com	
NO DRAWING IS OUR PROPERTY - REPRODUCTION FORBIDDEN			

Drawing designating barcode to particular components

AIR THERM GRAVITEC		GOUTTIERE		FABRICATION 5XA	
ITEM	CODE	DESCRIPTION TYPE GOUTTIERE		QTE	
1		GS		164	
2		GN		80	
3		G1-L		4	
4		G1-R		4	

PROJECT: 5XA		TITLE: GOUTTIERE- CODES			AT CODE: P2734		GRAVITEC VENTILADOR		
DRAWN BY : D.A.		VERIFIED BY : L.V.		APPROVED BY : E.G.B.		DATE: 07-01-26		REV: 00	
DRAWING NUMBER: 06-5480-1								AIR-THERM INC. www.air-therm.com <small>THIS DRAWING IS OUR PROPERTY - REPRODUCTION FORBIDDEN</small>	

Drawing designating barcode to particular components

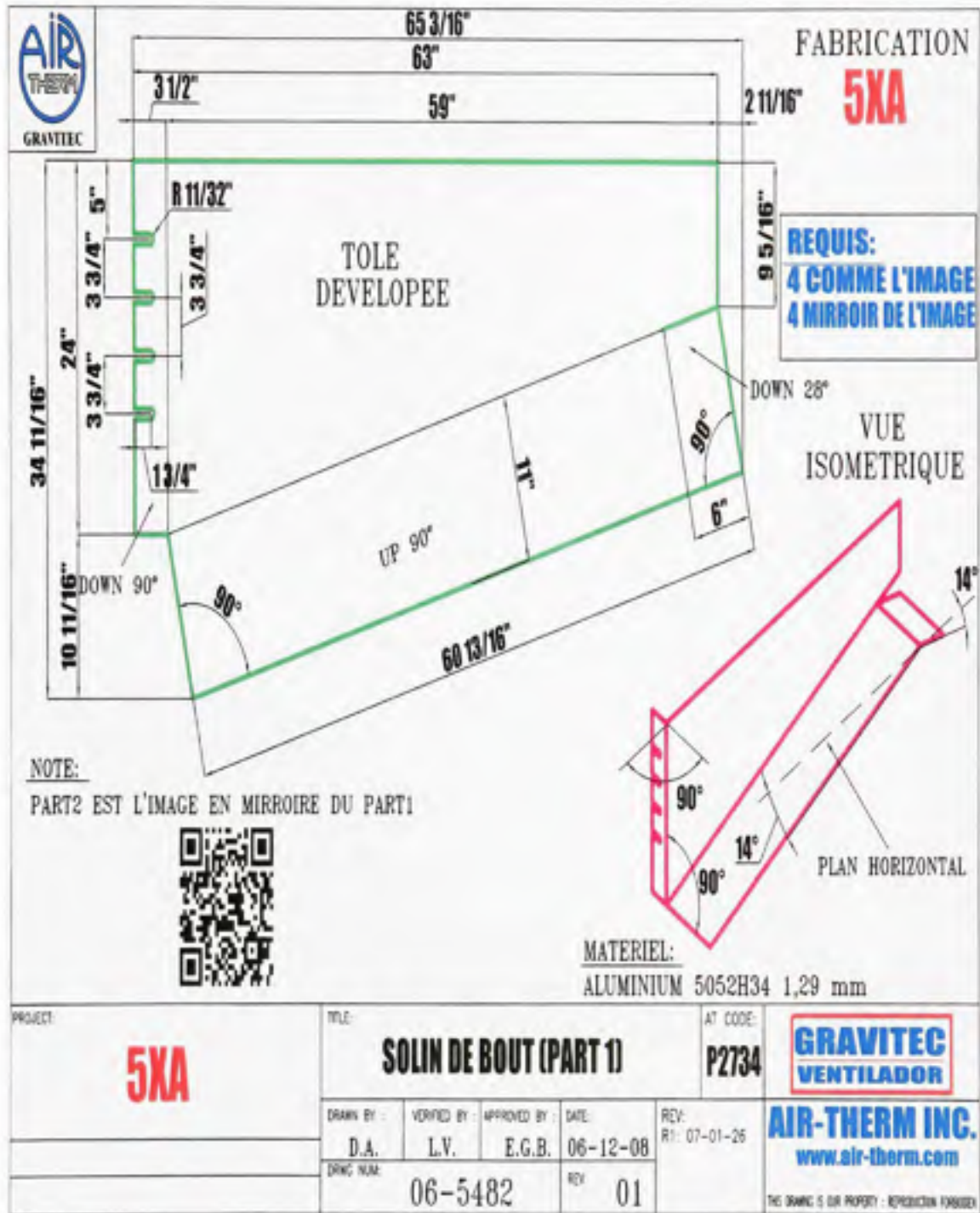

Individual component drawing with readable barcode on the drawing

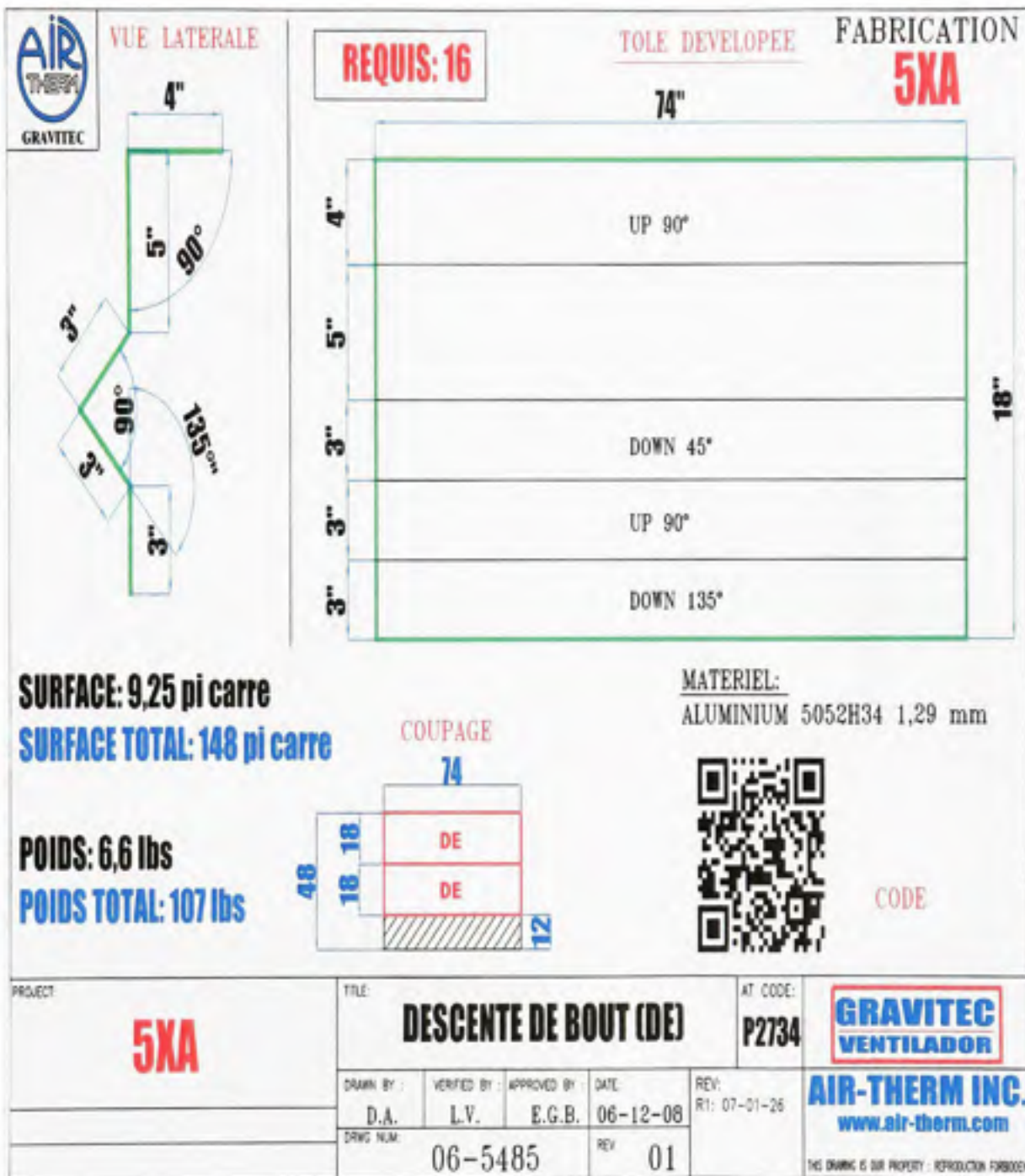

Individual component drawing with readable barcode on the drawing

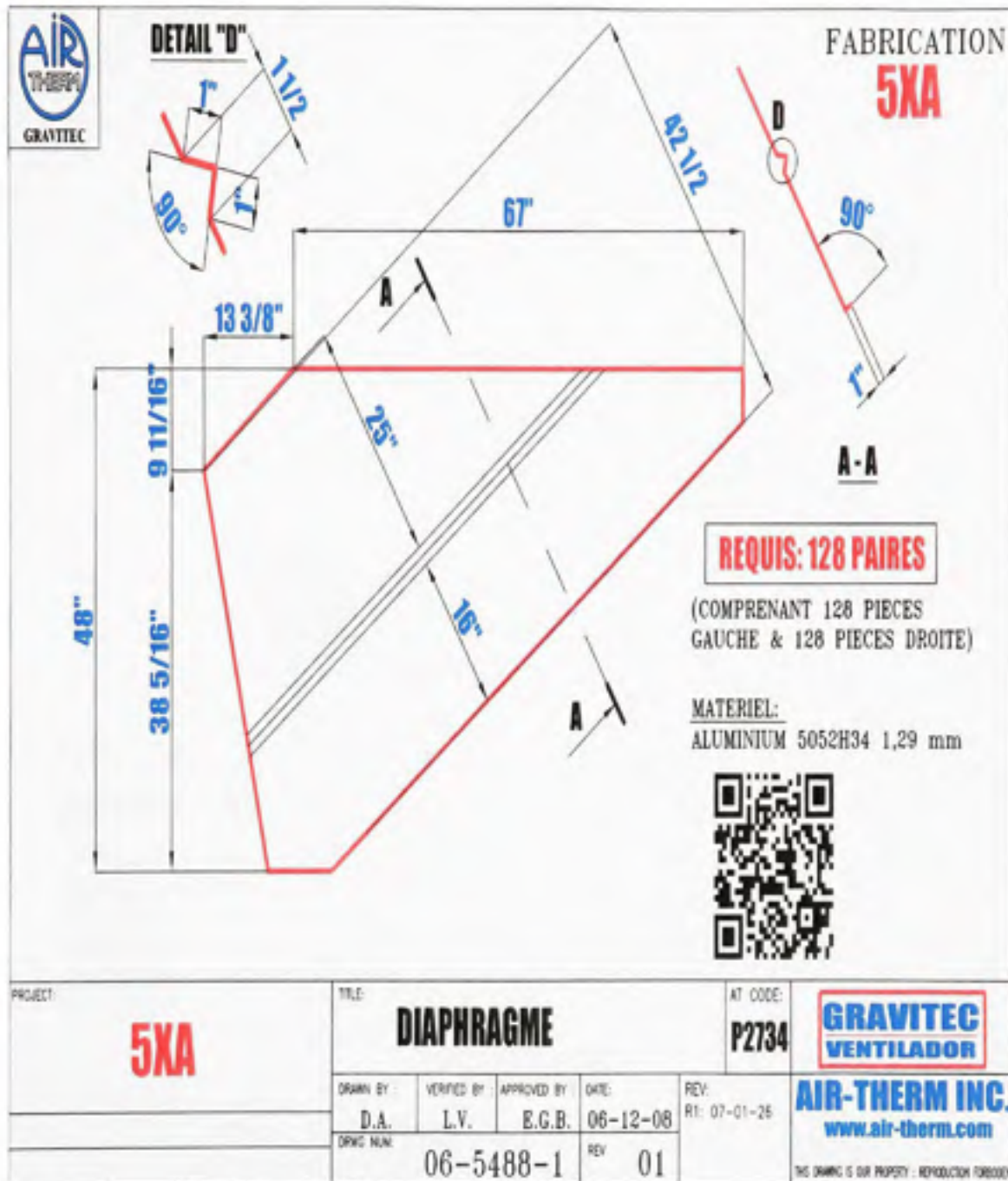

Individual component drawing with readable barcode on the drawing

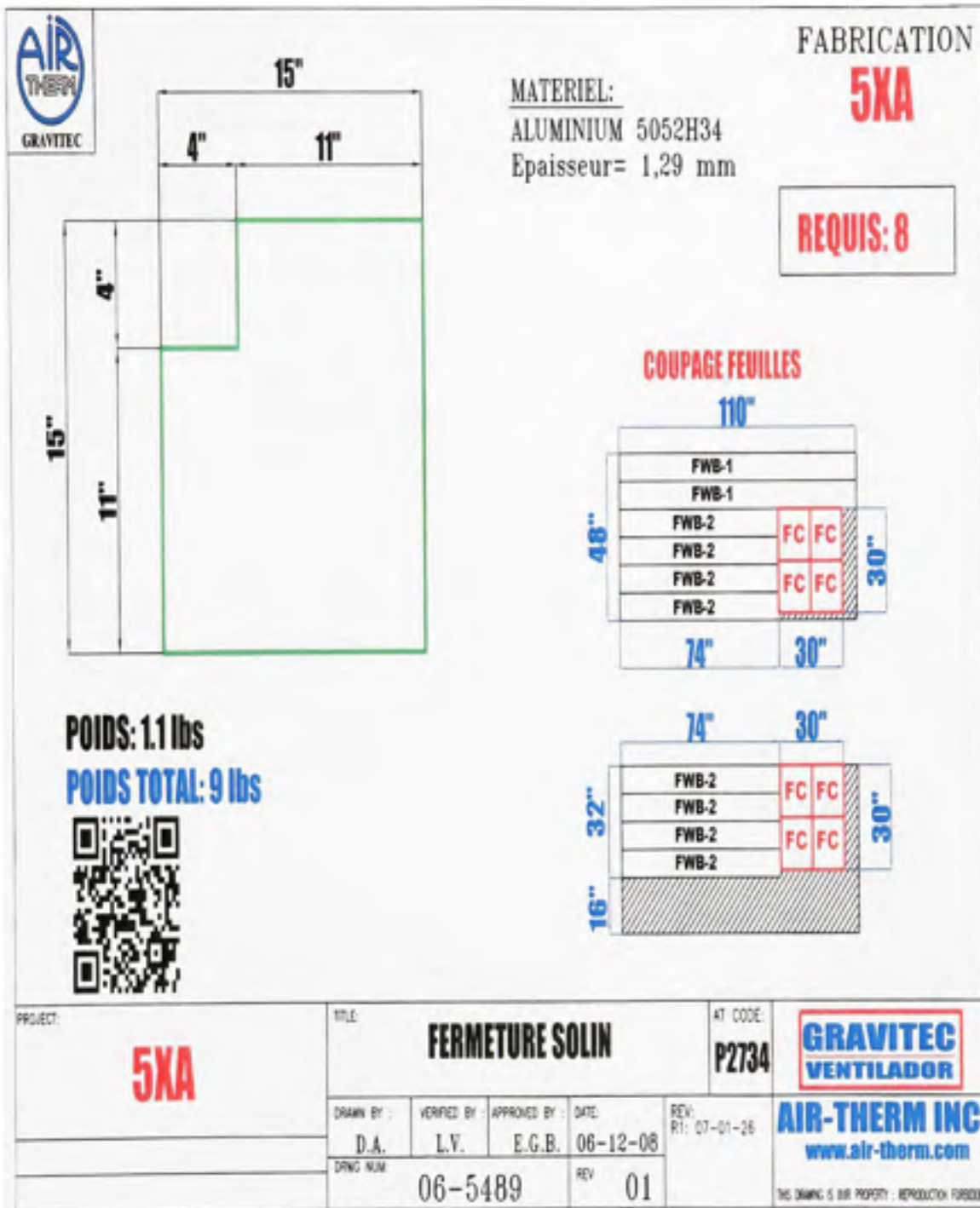

Individual component drawing with readable barcode on the drawing

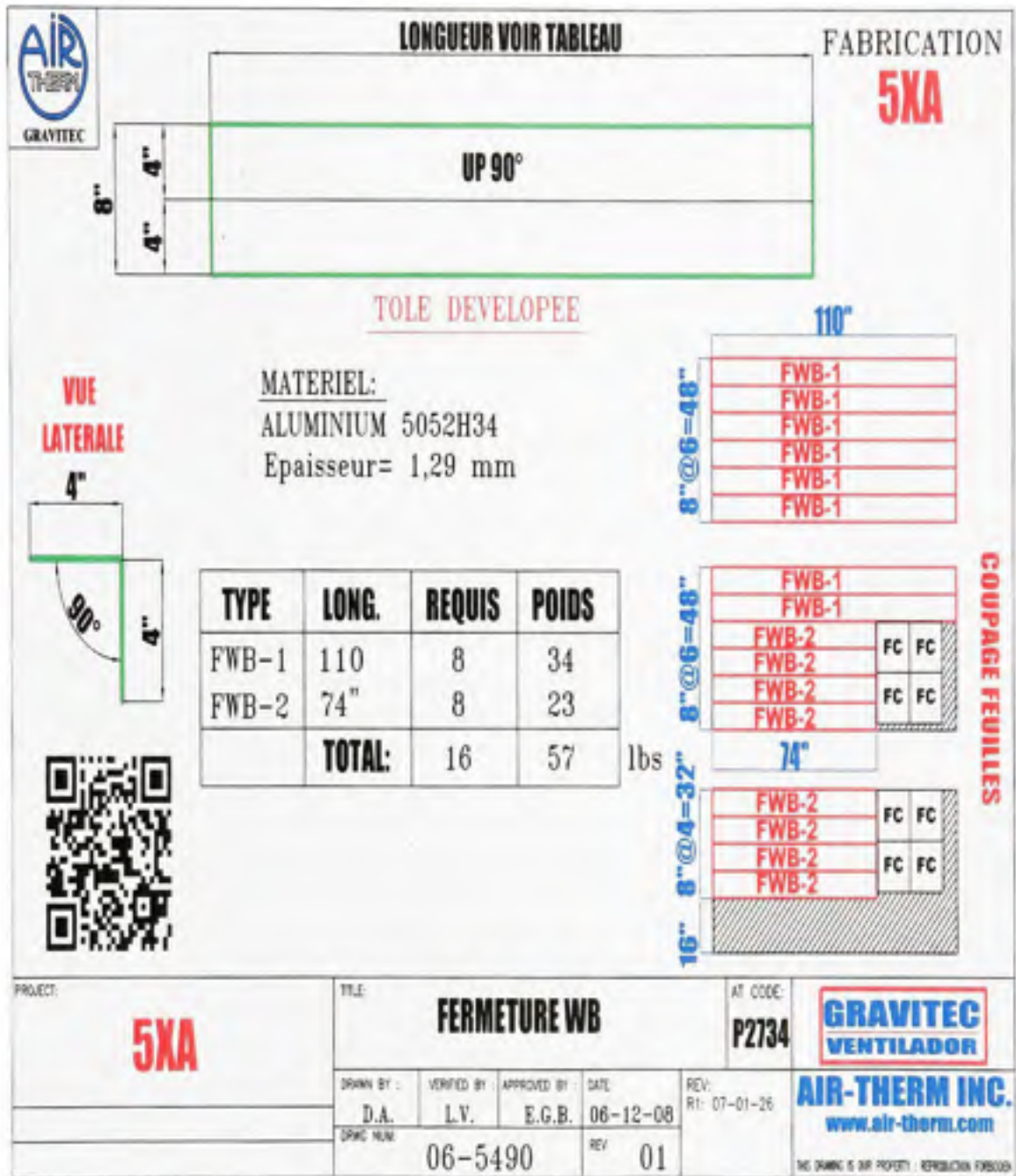

Individual component drawing with readable barcode on the drawing with cutting program

Equipment Number	Material Description	Total Quantity	WEIGHT (kg / unit)
AYVLFJA00002	Gravity Roof Ventilators		
AYVL00001	VG-3000 GRAVITEC VENTILATOR FRAME "A", TYPE A-L	1048	111.4
AYVL00002	VG-3000 GRAVITEC VENTILATOR FRAME "A", TYPE A-R	1048	111.4
AYVL00003	VG-3000 GRAVITEC VENTILATOR FRAME "B"	1048	97.4
AYVL00004	VG-3000 GRAVITEC VENTILATOR FRAME "C", TYPE 75/FC	796	93
AYVL00005	VG-3000 GRAVITEC VENTILATOR FRAME "C", TYPE 60/BC	252	92.7
AYVL00006	VG-3000 GRAVITEC VENTILATOR ANGLES, TYPE No7	1048	45.7
AYVL00007-1	VG-3000 GRAVITEC VENTILATOR ANGLES, TYPE No8 - ITEM 1=2244mm	1280	18.5
AYVL00007-3	VG-3000 GRAVITEC VENTILATOR ANGLES, TYPE No8 - ITEM 2=2094mm	372	17.3
AYVL00007-3	VG-3000 GRAVITEC VENTILATOR ANGLES, TYPE No8 - ITEM 3=300mm	200	2.5
AYVL00007-4	VG-3000 GRAVITEC VENTILATOR ANGLES, TYPE No8 - ITEM 4=1844mm	96	15.2
AYVL00007-5	VG-3000 GRAVITEC VENTILATOR ANGLES, TYPE No8 - ITEM 5=1454mm	8	12.3
AYVL00007-4	VG-3000 GRAVITEC VENTILATOR ANGLES, TYPE No8 - ITEM 6=744mm	16	6.3
AYVL00083	VG-3000 GRAVITEC VENTILATOR ANGLES, TYPE No8 - ITEM 7=844mm	32	5.14
AYVL00084	VG-3000 GRAVITEC VENTILATOR ANGLES, TYPE No8 - ITEM 8=1589mm	16	12.14
AYVL00085	VG-3000 GRAVITEC VENTILATOR ANGLES, TYPE No8 - ITEM 9=1599mm	16	12.2
AYVL00008	VG-3000 GRAVITEC VENTILATOR ANGLES, TYPE No21	1048	2.0
AYVL00009	VG-3000 GRAVITEC VENTILATOR ANGLES, TYPE No22	222	27.9
AYVL00087	VG-3000 GRAVITEC VENTILATOR ANGLES, TYPE SUPPORT END PANELS=1810mm	8	24.4
AYVL00014	VG-3000 GRAVITEC FASTENERS, BOLT AND NUT - A325 3/4"	4128	23.4 / 100 pcs
AYVL00015	VG-3000 GRAVITEC FASTENERS, BOLT AND NUT - A325 5/8"	28000	17.7 / 100 pcs
AYVL00016	VG-3000 GRAVITEC FASTENERS, SCREW #14 HHX	155000	7.0 / 1000 pcs
AYVL00017	VG-3000 GRAVITEC FASTENERS, SCREW #14 HHX	113000	7.9 / 1000 pcs
AYVL00018	VG-3000 GRAVITEC FASTENERS, CAULKING-CARTRIDGE Boxes (10 per Box)	23	17.2 / box
AYVL00019	VG-3000 GRAVITEC FASTENERS, TAPE-ROLLS Boxes (10 per Box)	26	17.2 / box
AYVL00020	VG-3000 GRAVITEC FASTENERS, EXPANSION JT MAT. - 50R Coil	15	22.6 / roll
AYVL00021	VG-3000 GRAVITEC AERO FLASHING, TYPE=F3 - 288mm	36	0.9
AYVL00022	VG-3000 GRAVITEC AERO FLASHING, TYPE=F14 - 1495mm	4	4.9
AYVL00023	VG-3000 GRAVITEC AERO FLASHING, TYPE=F16AR - 2286mm	12	7.4
AYVL00024	VG-3000 GRAVITEC AERO FLASHING, TYPE=F16AL - 2286mm	12	7.4
AYVL00025	VG-3000 GRAVITEC AERO FLASHING, TYPE=F169R - 2200mm	8	7.2
AYVL00026	VG-3000 GRAVITEC AERO FLASHING, TYPE=F169L - 2200mm	8	7.2
AYVL00053	VG-3000 GRAVITEC AERO FLASHING, TYPE=F16 - 1945mm	8	7.7
AYVL00027	VG-3000 GRAVITEC AERO FLASHING, TYPE=F21AL - 2286mm	44	7.4

Inventory control sheets with manual and barcode columns

AYVL00028	VG-3000 GRAVITEC AERO FLASHING, TYPE-F21AR - 2286mm	44	7.4
AYVL00029	VG-3000 GRAVITEC AERO FLASHING, TYPE-F21BL - 2200mm	46	7.2
AYVL00030	VG-3000 GRAVITEC AERO FLASHING, TYPE-F21BR - 2200mm	46	7.2
AYVL00031-1	VG-3000 GRAVITEC AERO FLASHING, TYPE-FEL - 1829mm	8	6.1
AYVL00031-2	VG-3000 GRAVITEC AERO FLASHING, TYPE-FER - 1829mm	8	6.1
AYVL00031-3	VG-3000 GRAVITEC AERO FLASHING, TYPE-FS - 2350mm	256	7.7
AYVL00054	VG-3000 GRAVITEC AERO FLASHING, TYPE-F45 - 2150mm	184	7.7
AYVL00055	VG-3000 GRAVITEC AERO FLASHING, TYPE-F45-R - 2590mm	4	8.0
AYVL00056	VG-3000 GRAVITEC AERO FLASHING, TYPE-F45-L - 2590mm	4	8.0
AYVL00057	VG-3000 GRAVITEC AERO FLASHING, TYPE-F55 - 2350mm	192	7.7
AYVL00031-4	VG-3000 GRAVITEC AERO FLASHING, TYPE-F75 - 888mm	4	2.7
AYVL00031-5	VG-3000 GRAVITEC AERO FLASHING, TYPE-FC - 381x381 mm	36	0.4
AYVL00066	VG-3000 GRAVITEC AERO FLASHING, TYPE-F75-ST - 750mm	4	2.4
AYVL00067	VG-3000 GRAVITEC AERO FLASHING, TYPE-F2107-R - 2286mm	2	7.4
AYVL00068	VG-3000 GRAVITEC AERO FLASHING, TYPE-F2107-L - 2286mm	2	7.4
AYVL00069	VG-3000 GRAVITEC AERO FLASHING, TYPE-F850-R - 1040mm	4	3.4
AYVL00070	VG-3000 GRAVITEC AERO FLASHING, TYPE-F850-L - 1040mm	4	3.4
AYVL00071	VG-3000 GRAVITEC AERO FLASHING, TYPE-F850-BR - 952mm	4	3.1
AYVL00072	VG-3000 GRAVITEC AERO FLASHING, TYPE-F850-BL - 952mm	4	3.1
AYVL00073	VG-3000 GRAVITEC AERO FLASHING, TYPE-F1995 - 2300mm	8	6.8
AYVL00074	VG-3000 GRAVITEC AERO FLASHING, TYPE-F2005 - 2300mm	8	6.8
AYVL00068	VG-3000 GRAVITEC AERO FLASHING, TYPE-F3-REV - 268mm	100	0.6
AYVL00069	VG-3000 GRAVITEC AERO FLASHING, TYPE-F14-REV - 1495mm	4	4.9
AYVL00090	VG-3000 GRAVITEC AERO FLASHING, TYPE-F18AR-REV - 2286mm	14	7.4
AYVL00091	VG-3000 GRAVITEC AERO FLASHING, TYPE-F18AL-REV - 2286mm	14	7.4
AYVL00092	VG-3000 GRAVITEC AERO FLASHING, TYPE-F18BR-REV - 2200mm	10	7.2
AYVL00093	VG-3000 GRAVITEC AERO FLASHING, TYPE-F18BL-REV - 2200mm	10	7.2
AYVL00094	VG-3000 GRAVITEC AERO FLASHING, TYPE-F21AL-REV - 2286mm	46	7.4
AYVL00095	VG-3000 GRAVITEC AERO FLASHING, TYPE-F21AR-REV - 2286mm	46	7.4
AYVL00096	VG-3000 GRAVITEC AERO FLASHING, TYPE-F21BL-REV - 2200mm	46	7.2
AYVL00097	VG-3000 GRAVITEC AERO FLASHING, TYPE-F21BR-REV - 2200mm	46	7.2
AYVL00098	VG-3000 GRAVITEC AERO FLASHING, TYPE-F5-REV - 2350mm	256	7.7
AYVL00099	VG-3000 GRAVITEC AERO FLASHING, TYPE-F45-REV - 2150mm	188	7.7
AYVL00100	VG-3000 GRAVITEC AERO FLASHING, TYPE-F55-REV - 2350mm	192	7.7
AYVL00101	VG-3000 GRAVITEC AERO FLASHING, TYPE-FEL-REV - 1829mm	8	6.1

Inventory control sheets with manual and barcode columns

AYVL00102	VG-3000 GRAVITEC AERO FLASHING, TYPE=F8R-REV - 1829mm	8	6.1
AYVL00103	VG-3000 GRAVITEC AERO FLASHING, TYPE=F75 -REV- 838mm	4	2.7
AYVL00104	VG-3000 GRAVITEC AERO FLASHING, TYPE=F75-ST -REV-750mm	4	2.4
AYVL00105	VG-3000 GRAVITEC AERO FLASHING, TYPE=F850-R-REV - 1040mm	4	3.4
AYVL00106	VG-3000 GRAVITEC AERO FLASHING, TYPE=F850-L-REV - 1040mm	4	3.4
AYVL00107	VG-3000 GRAVITEC AERO FLASHING, TYPE=F850-BR-REV - 952mm	4	3.1
AYVL00108	VG-3000 GRAVITEC AERO FLASHING, TYPE=F850-BL-REV- 952mm	4	3.1
AYVL00109	VG-3000 GRAVITEC AERO FLASHING, TYPE=F1995 -REV- 2100mm	8	6.8
AYVL00110	VG-3000 GRAVITEC AERO FLASHING, TYPE=F2005 -REV- 2100mm	8	6.8
AYVL00111	VG-3000 GRAVITEC AERO FLASHING, TYPE=F45-ST -REV- 2245mm	4	7.3
AYVL00112	VG-3000 GRAVITEC AERO FLASHING, TYPE=FC -REV- 381x381 mm	16	0.4
AYVL00032	VG-3000 GRAVITEC AERO GUTTER, TYPE=G3 - 288mm	196	0.5
AYVL00033	VG-3000 GRAVITEC AERO GUTTER, TYPE=G14L - 1500mm	4	2.5
AYVL00034	VG-3000 GRAVITEC AERO GUTTER, TYPE=G14R - 1500mm	4	2.5
AYVL00035	VG-3000 GRAVITEC AERO GUTTER, TYPE=G18L - 2286mm	44	3.8
AYVL00036	VG-3000 GRAVITEC AERO GUTTER, TYPE=G18R - 2286mm	44	3.8
AYVL00048	VG-3000 GRAVITEC AERO GUTTER, TYPE=G18-1945mm	8	3.5
AYVL00037	VG-3000 GRAVITEC AERO GUTTER, TYPE=G21 - 2286mm	194	3.8
AYVL00038-1	VG-3000 GRAVITEC AERO GUTTER, TYPE=G21H - 2286mm	184	3.8
AYVL00038-2	VG-3000 GRAVITEC AERO GUTTER, TYPE=G75L - 848mm	9	1.4
AYVL00038-3	VG-3000 GRAVITEC AERO GUTTER, TYPE=G75R - 848mm	8	1.4
AYVL00039	VG-3000 GRAVITEC AERO GUTTER, TYPE=G5 - 2350mm	824	5.3
AYVL00040	VG-3000 GRAVITEC AERO GUTTER, TYPE=G5H - 2350mm	440	5.3
AYVL00059	VG-3000 GRAVITEC AERO GUTTER, TYPE=GE-R- 2591mm	5	5.8
AYVL00060	VG-3000 GRAVITEC AERO GUTTER, TYPE=GE-L - 2591mm	4	5.8
AYVL00075	VG-3000 GRAVITEC AERO GUTTER, TYPE=G850 - 1040mm	20	2.6
AYVL00076	VG-3000 GRAVITEC AERO GUTTER, TYPE=G850-H - 1040mm	12	2.6
AYVL00077	VG-3000 GRAVITEC AERO GUTTER, TYPE=GS-R- 2350mm	4	5.3
AYVL00078	VG-3000 GRAVITEC AERO GUTTER, TYPE=GS-L - 2350mm	4	5.3
AYVL00079	VG-3000 GRAVITEC AERO GUTTER, TYPE=G2005 - 2095mm	24	4.8
AYVL00080	VG-3000 GRAVITEC AERO GUTTER, TYPE=G2005-H - 2095mm	8	4.8
AYVL00041	VG-3000 GRAVITEC CAP, TYPE=C3 - 288mm	98	0.8
AYVL00042	VG-3000 GRAVITEC CAP, TYPE=C14 - 1600mm	4	4.6
AYVL00043	VG-3000 GRAVITEC CAP, TYPE=C18 - 2200mm	4	6.4
AYVL00081	VG-3000 GRAVITEC CAP, TYPE=C18-A - 2200mm	26	6.4
AYVL00044	VG-3000 GRAVITEC CAP, TYPE=C18B - 2350mm	16	6.8

Inventory control sheets with manual and barcode columns

AYVL00045	VG-3000 GRAVITEC CAP, TYPE=C21A - 2200mm	92	6.4
AYVL00046-1	VG-3000 GRAVITEC CAP, TYPE=C21B - 2350mm	92	6.8
AYVL00046-2	VG-3000 GRAVITEC CAP, TYPE=C75 - 750mm	4	2.1
AYVL00046-3	VG-3000 GRAVITEC CAP, TYPE=CS - 2350mm	634	6.8
AYVL00062	VG-3000 GRAVITEC CAP, TYPE=CE - 2692mm	4	7.5
AYVL00081	VG-3000 GRAVITEC CAP, TYPE=C75-ST - 838mm	4	2.3
AYVL00082	VG-3000 GRAVITEC CAP, TYPE=C2005 - 2090mm	16	6
AYVL00083	VG-3000 GRAVITEC CAP, TYPE=CE2 - 2235mm	2	6.8
AYVL00084	VG-3000 GRAVITEC CAP, TYPE=CR50-A - 946mm	8	2.4
AYVL00085	VG-3000 GRAVITEC CAP, TYPE=CR50-B - 1054mm	8	2.5
AYVL000113	VG-3000 GRAVITEC CAP, TYPE=C45-ST - 2350mm	2	6.8
AYVL00047	VG-3000 GRAVITEC DOWNSPOUT, TYPE=DS - 1625mm	736	2.35
AYVL00048	VG-3000 GRAVITEC DOWNSPOUT, TYPE=DE - 1930mm	56	3.6
AYVL00049	VG-3000 GRAVITEC DIAPHRAGM, TYPE=DIAPH, 1219x2146mm	474	8.2
AYVL00050	VG-3000 GRAVITEC SUPPORT DOWNSPOUT, TYPE=SD, 76x254mm	772	0.1
AYVL00052	VG-3000 GRAVITEC CLADDING CORNER, TYPE=WBC, 1300x100x2540mm	32	2.44
AYVL00086	VG-3000 GRAVITEC-PAINT C/W CONVERTER, GALONS	4	

Inventory control sheets with manual and barcode columns

APPENDIX III

DEMONSTRATOR READ-OUTS OF MONITOR RESULTS

These are the demonstrator read-out from the personal digital assistants as used by factory and jobsite personnel.

Several variant were developed and utilized. Including change of screen colour design and language to conform to needs of a number of different situations.

The basic programs used were Microsoft Office for Mobile PC, Adobe Products and in-house mobile version of Microstation capable of low bandwidth .dxf drawing reading (developed from an open source : outside the scope of this study).

Project Status

HPM MONITOR

BAR CODES PROJECT

Step	Comp.	YY-MM-DD
PROJECT ENG.	<input checked="" type="checkbox"/>	07-06-20
PROJECT SPEC	<input checked="" type="checkbox"/>	07-06-20
LOT PROCURED	<input checked="" type="checkbox"/>	07-06-20
DWG. REVIEW	<input checked="" type="checkbox"/>	07-06-20
SUPPLIER PROC.	<input checked="" type="checkbox"/>	07-06-20
SUPPLIER INVENT	<input checked="" type="checkbox"/>	07-06-20
SUPPLIER FAB	<input checked="" type="checkbox"/>	07-06-20
INSPECTED	<input type="checkbox"/>	
EXPEDITED	<input type="checkbox"/>	
SITE INVENTORY	<input type="checkbox"/>	
SITE ASSEMBLY	<input type="checkbox"/>	
SITE INSTALLATION	<input type="checkbox"/>	
HP APPROVED	<input type="checkbox"/>	

STATUS MONITOR			
STEP	N	Y	DATE
PROJECT ENG.			
PROJECT SPEC			
LOT PROCURED			
DWG. REVIEW			
SUPPLIER PROC.			
SUPPLIER INVENT			
SUPPLIER FAB			
INSPECTED			
EXPEDITED			
SITE INVENTORY			
SITE ASSEMBLY			
SITE INSTALLATION			
HP APPROVED			

ORGANIZATIONAL LOGIC DIAGRAM

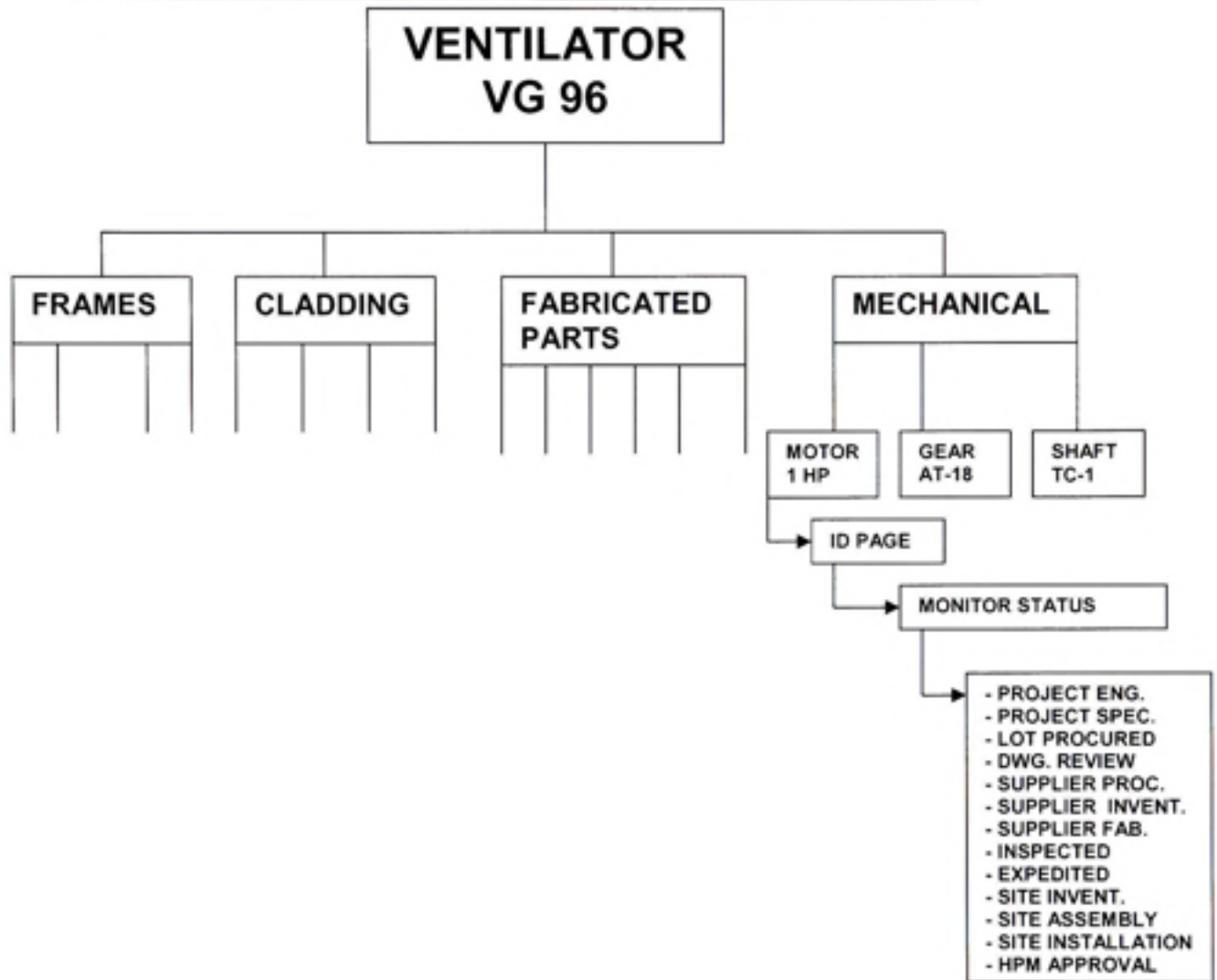

AIR-THERM INC. – VG 96 MECHANICAL ASSEMBLY

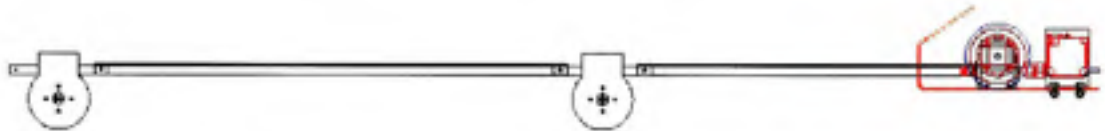

QR CODE	COMPONENT	AT #
	MOTOR 1 HP	AT-B7-0001
	GEAR G1BMQ 818- 60- 140TC	AT -B7-0002
	ROTARY LIMIT SWITCH	AT -B7-0003
	MECHANICAL SHAFT TC1	AT -B7-0004
	MECHANICAL SHAFT TC2	AT -B7-0005
	GEAR AT-18	AT -B7-0006
	COUPLING FC15- ½"	AT -B7-0007
	COUPLING FC15- 7/8"	AT -B7-0008
	MECHANICAL PLATE	AT -B7-0009
	LIMIT SWITCH PLATE	AT M-B7-0010

AIR-THERM INC.
VG 96

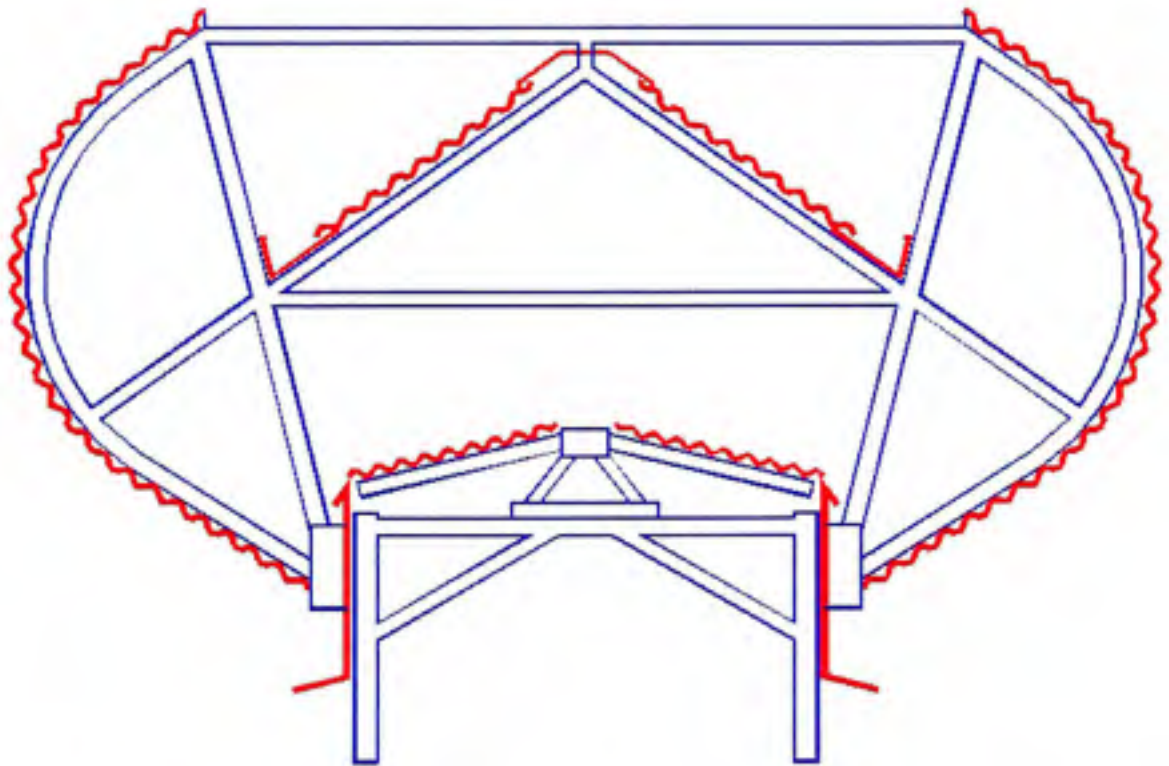

COMPONENT	QR CODE	HPM #
FRAMES		
CLADDING		
FAB PARTS		
MECHANICAL		

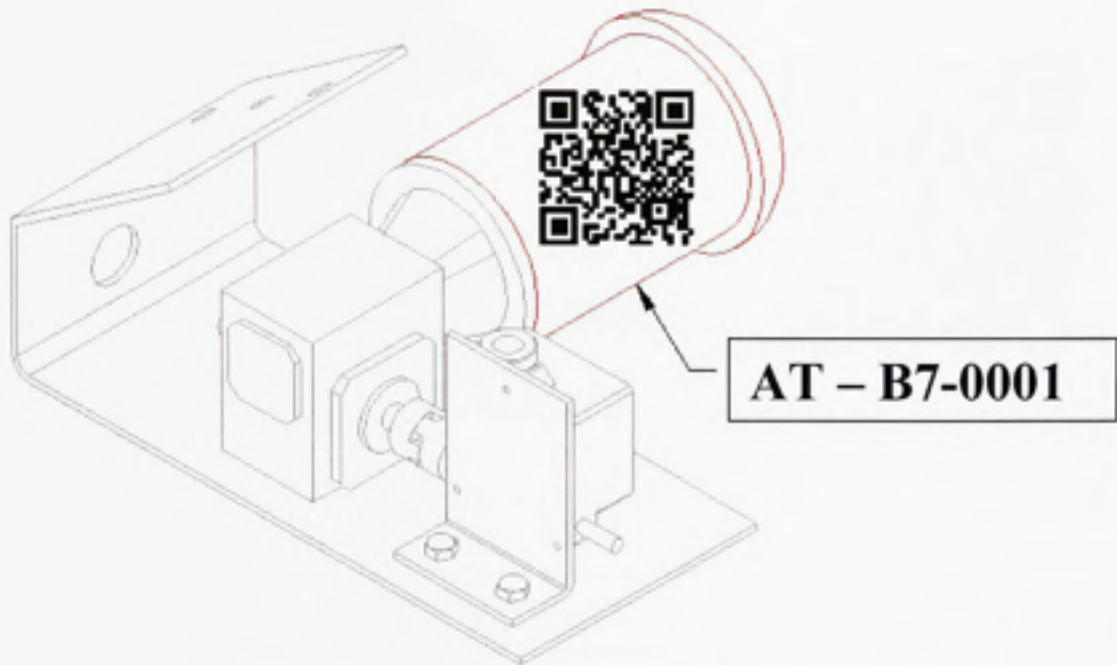

ITEM TO BE SCANNED – SITE CONDITION

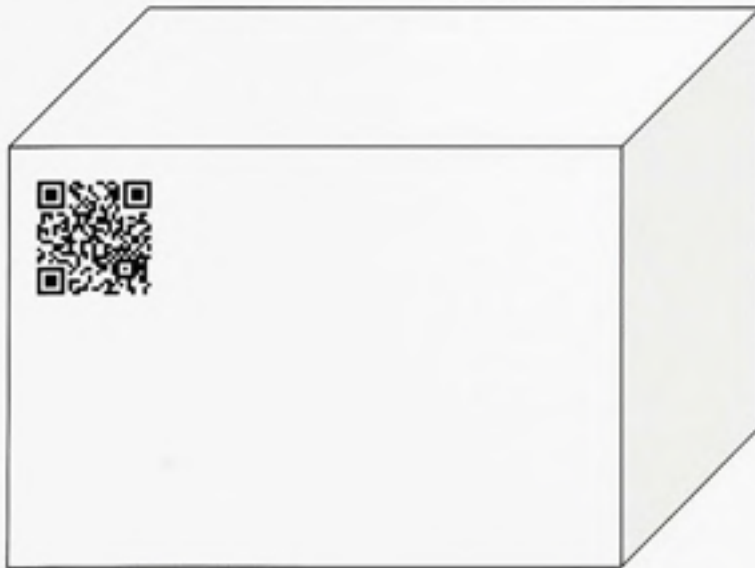

**ITEM IN BOX SCANNABLE – EXPEDITABLE
CONDITION**

AIR-THERM INC.

INFO@AIR-THERM.COM

WWW.AIR-THERM.COM

AUTHORISED TOSHIBA DEALER



TECHNICAL DATES FOR MO 401F4T4

MANUFACTURER	TOSHIBA
MODEL NUMBER	BOO14FLF1BMHD02
LINE	XS-840
POWER	1 HP
RPM	1800
VOLTAGE	460 V
Hz	60
FRAME SIZE	143 TC
	TEFC
EFFICIENCY	PREMIUM
WEIGHT	75 Lbs (34 kg)

STATUS MONITOR

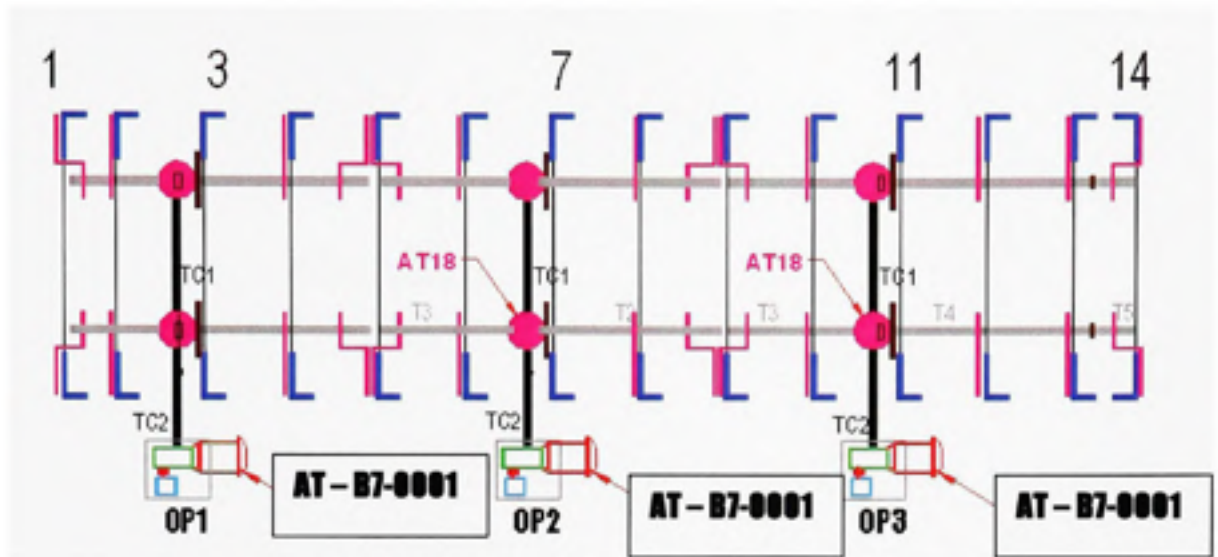

PROJECT SPECIFICATION FOR:

MOTOR 1HP- TOSHIBA

1 ELECTRICAL SPECIFICATION

AMBN -YRS-FTOS-E-1112

2 MOTOR SPECIFICATION

AMBN -YRS-FTOS-E-1114

3 PAINT SPECIFICATION

AMBN -YRS-FTOS-E-1124

4 ATTACHMENT SPECIFICATION

AMBN -YRS-FTOS-E-1126

5 SAFETY SPECIFICATION

AMBN -YRS-FTOS-E-1500

6 TAGGING SPECIFICATION

AMBN -YRS-FTOS-E-1000

7 MANUAL SPECIFICATION

AMBN -YRS-FTOS-E-1010

BAR CODES PROJECT
PILOT PROJECT

PURCHASE ORDER - REVISION

P.O. # : 24956-323-POA-AYVL-00002
REVISION 9

AIR-THERM INC.www.air-therm.com

Tel. : (514)482 2067

Fax : (514) 482 6806

PURCHASE ORDER

ORDER TO :	TOSBEC INC. 12885 RUE JEAN GROU MONTREAL, QC, H1A 3N6	SHIP TO :	AIR-THERM INC. 5801 MONKLAND AVE MONTREAL, QC, H4A 1G4
PROJECT :	BAR CODES PILOT PROJECT	ATTENTION TO :	
DATE:	22 MAY, 2007	/GST No	EXTRA (6%)
DATE REQUIRED	ASAP	GST No :	EXTRA (7.5%)
		F.O.B.	MONTREAL
		VIA :	CAMION
		PURCHASE ORDER :	
		C 2704	
QUANTITY	DESCRIPTION	PRICE PER UNIT	TOTAL
3 (THREE)	MO401 F4T4 TOSHIBA XS-840 MOTOR TOSHIBA EQP111-XS 1HP, 1800 RPM, 460 VOLTS, 3 PH, 60 HZ, TEFC, 143 TC FLANGE		
TERMS: NET (30) DAYS			

BAR CODES PROJECT
PILOT PROJECT

DESCRIPTION	PART #	STOCK QTY	DATE
MOTOR 1HP	AT - B7-0001	3	5/23/2007



BAR CODES PROJECT
PILOT PROJECT

INSPECTION

DESCRIPTION	REMARKS
VISUAL	OK
PARAMETERS	OK
ISSUE DATE	2/5/2007

APPENDIX IV

AIR-THERM VENTILATOR TECHNICAL DATA SHEET

This 13 page presentation is for an innovative gravity ventilator system develop for 5 major new projects. integrated into this new design is the proposed and demonstrated bar code driven inventory control system.

The design of this ventilator and the strategy for design and fabrication would not be possible without the barcode driven inventory control system described and demonstrated in this paper.

Natural Thermodynamic Solutions

AIR-THERM

TECHNICAL DATA SHEET

NATURAL VENTILATION : GREEN SOLUTION

AIR-THERM GRAVITEC LOW PROFILE

TYPE – K/R2



(Air-Therm Low Profile Ventilators on "Google Earth": Better flow cleaner vent !!!)

AIR-THERM INC.
1 514 482 2067
www.air-therm.com
info@air-therm.com

Natural Thermodynamic Solutions

AIR-THERM

1. PRODUCT INFORMATION
2. MATERIAL SPECIFICATION
3. PRODUCT TESTING
4. TECHNICAL DRAWINGS
5. PROJECTS COMPLETED

AIR-THERM INC.
1 514 482 2067
www.air-therm.com
info@air-therm.com

Natural Thermodynamic Solutions

AIR-THERM

1. PRODUCT INFORMATION

Air-Therm's proposed ventilator for the QATALUM project is our K/R2 Low Profile Design Ventilator. This ventilator is backed by utilisation and approval by numerous projects and consulting firms including SNC-Lavalin.

Air-Therm ventilators assure SAFETY AND HYGIENE.

Air-Therm proposed ventilators shall extract specified heat while specialised Air-Therm monitor diverter plates direct the airflow towards the potroom central axis. This has been proven using real smokeflow testing and ventilators delivered and observed under real world conditions.

Air-Therm K/R2 ventilators are proven to be weather resistant under positive operating conditions. The K/R2 are self draining and designed to eliminate the specified 75 mm/hour of rain.

Easy to Assemble. Easy to Install. Proven industrial applications. Competitive Pricing. On schedule conformity.

AIR-THERM INC.
1 514 482 2067
www.air-therm.com
info@air-therm.com

Natural Thermodynamic Solutions

AIR-THERM



ALL ALUMINIUM CONSTRUCTION



AIR-THERM K-R2 TEST MODULE

Natural Thermodynamic Solutions

AIR-THERM

2. MATERIAL SPECIFICATION

A. ROLL FORMED SECTIONS :

0,9mm 5052 H32 ALUMINIUM

ROLL FORMING TO BE CARRIED OUT
IN GCC BY PROJECT APPROVED FACILITY

B. FABRICATED COMPONENTS: INCLUDING SPECIALISED MONITOR DIVERter PLATES

1,2 mm 5052 H32 ALUMINIUM

C. ASSEMBLY FASTENERS TO BE STAINLESS STEEL WITH METAL WASHERS AND ZERO UV EPDM WEATHER SEALS

D. VENTILATOR TO ROOF BOLTING SHALL BE GRADE 8.8 BOLTS, NUTS AND WASHERS

AIR-THERM INC.
1 514 482 2067
www.air-therm.com
info@air-therm.com

Natural Thermodynamic Solutions

AIR-THERM

3. PRODUCT TESTING

AIR-THERM VENTILATORS ARE TESTED
6 DIFFERENT WAYS

1. A.S.H.R.A.E.

$$Q_s = C_d A \sqrt{2 g H_d \frac{T_I - T_O}{T_I}}$$

2. COMPUTATIONAL ANALYSIS: AIR-THERM CALCULATIONS HAVE BEEN VERIFIED AND APPROVED UTILISING CFD MODELING TECHNIQUES. BOTH IN HOUSE AND BY SNC-LAVALIN, HATCH AND ASSOCIATES AND BECHTEL CORPORATION.

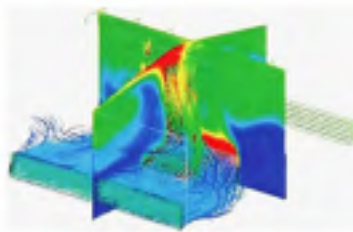

In House CFD Modeling

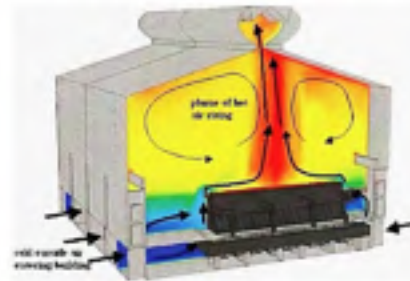

Modeling of Air-Therm Vent by EPCM



Detailed Internal Airflow and Component Analysis

3. **RIGOROUS** PRODUCT TESTING. AIR-THERM LOW PROFILE UNITS HAVE BEEN TESTED AND APPROVED BY NUMEROUS INDEPENDANT ENGINEERS AND TECHNICAL INSTITUTIONS.



ULTIMATE



OLD UNIV. TECH.

EACH COMPONENT TO

OUR VENTILATORS WERE TESTED FOR MECHANICAL AND STRUCTURAL CHARACTERISTICS AS ENTIRE UNITS, AS INDIVIDUAL COMPONENTS AND APPROVED FOR THEIR INTENDED APPLICATION.

AIR-THERM INC.
1 514 482 2067
www.air-therm.com
info@air-therm.com

Natural Thermodynamic Solutions

AIR-THERM

4. BUILDING OF TEST SAMPLE SECTIONS. AIR-THERM IS SIGNIFICANTLY MORE RIGOROUS THAN ANY OTHER TESTING. BEFORE WE PUT OUR NAME ON OUR VENTILATORS COMPLETE TESTING IS CONDUCTED WITH ALL PROJECT PARTNER ALWAYS INVITED TO ATTEND:

STRUCTURAL LOADING TESTS

SMOKE TESTINGS

ANEMOMETRIC AIR FLOW TESTING

DOPPLER EFFECT VELOCITY / VOLUME FLOW TESTING

WATER INFILTRATION / PENETRATION TESTING



PROJECT INSPECTION TEAM

AIR-THERM INC.
1 514 482 2067
www.air-therm.com
info@air-therm.com

Natural Thermodynamic Solutions

AIR-THERM

5. **REAL PROJECTS: REAL EXPERIENCE:** BETTER THAN ANY OTHER TEST. AIR-THERM LOW PROFILE VENTILATOR HAVE PROVEN THEMSELVES FROM EASY ASSEMBLY AND INSTALLATION TO YEARS OF TROUBLE FREE UTILISATION



EXCELLENT LIGHT



AIR-THERM LOW PROFILE VENTS

6. AIR-THERM ENGINEERING HAS BEEN CERTIFIED FOR UTILISATION BY SOME OF THE WORLD'S MOST STRINGENT BUILDING CODES SYSTEMS INCLUDING:

CANADIAN NATIONAL BUILDING CODES
 NUMEROUS AMERICAN STATES BUILDING CODES
 STANDARDS AUSTRALIA
 SEVERAL SOUTH AMERICAN NATIONAL CODE SYSTEMS
ICELANDIC BUILDING CODE (NEW EN NORMS)
NORWEGIAN BUILDING CODE (NEW NORMS)

AIR-THERM INC.
 1 514 482 2067
www.air-therm.com
info@air-therm.com

Natural Thermodynamic Solutions

AIR-THERM

4. TECHNICAL DRAWINGS

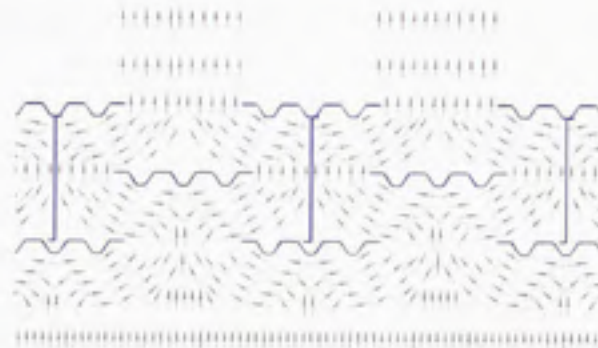

ANALYSIS OF AIRFLOW THROUGH KR2 VENTILATOR

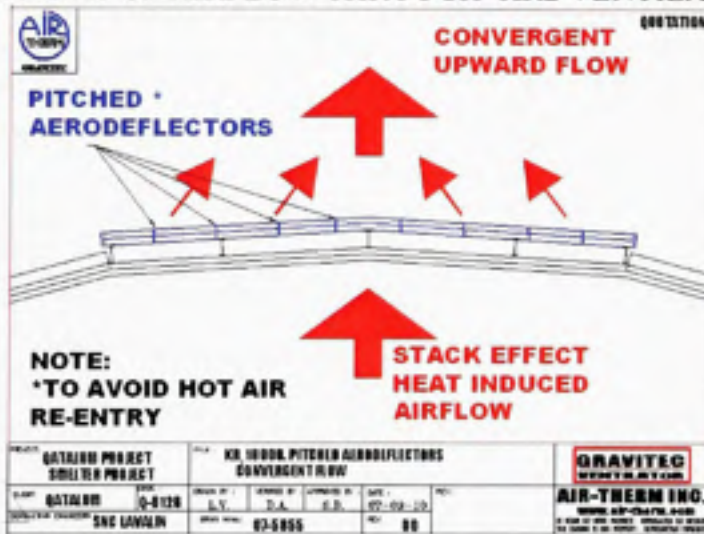

AIR-THERM INC.
 1 514 482 2067
www.air-therm.com
info@air-therm.com

Natural Thermodynamic Solutions

AIR-THERM

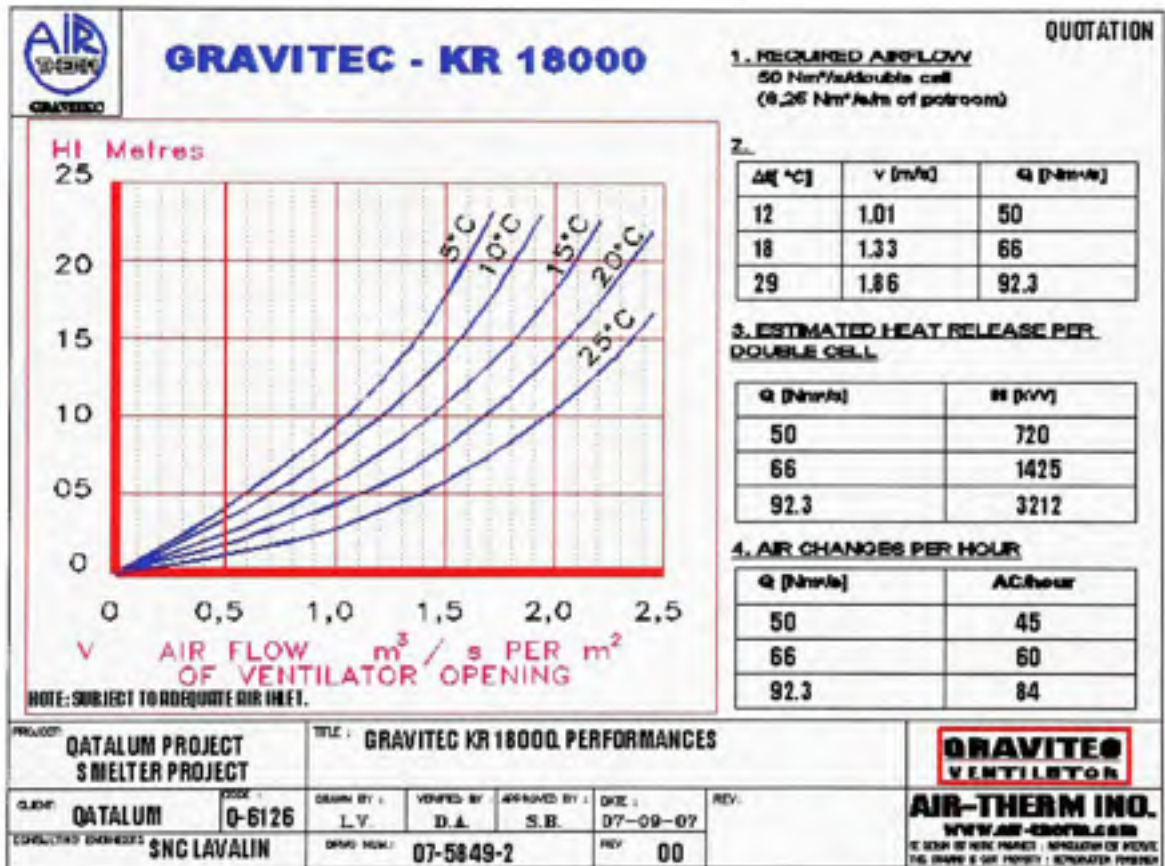

HEAT EXHAUST CALCULATION FOR QATALUM USING AIR-THERM K/R2
VENTILATOR

Natural Thermodynamic Solutions

AIR-THERM

NOTE:
VENTILATOR DESIGN CAPACITY = 100 mm per hour

PROJECT	QATALUM PROJECT SMELTER PROJECT	FILE	POTROOM WITH LOW PROFILE VENTILATOR NR, 18000			GRAVITEC VENTILATOR AIR-THERM INC. www.air-therm.com <small>10, 11, 12, 13, 14, 15, 16, 17, 18, 19, 20, 21, 22, 23, 24, 25, 26, 27, 28, 29, 30, 31, 32, 33, 34, 35, 36, 37, 38, 39, 40, 41, 42, 43, 44, 45, 46, 47, 48, 49, 50, 51, 52, 53, 54, 55, 56, 57, 58, 59, 60, 61, 62, 63, 64, 65, 66, 67, 68, 69, 70, 71, 72, 73, 74, 75, 76, 77, 78, 79, 80, 81, 82, 83, 84, 85, 86, 87, 88, 89, 90, 91, 92, 93, 94, 95, 96, 97, 98, 99, 100</small>
CLIENT	QATALUM 0-6126	DRAWN BY	ISSUED BY	APPROVED BY	DATE	
CONTRACT NUMBER	SNC Lavalin	SNC PROJ	07-5859	REV	00	

AIR-THERM KR2 IS DESIGNED FOR PROJECT SPECIFIC WEATHER RESISTANCE TO 100mm/HOUR

ACCORDING TO
ASHRAE HANDBOOK -2005 FUNDAMENTALS, CHAPTER 27 - VENTILATION AND INFILTRATION -
Flow Caused by Thermal Factors Only
If building airtightness is not significant, the flow caused by each effect can be expressed by:

$$Q = C_d A_o \sqrt{2gH(\Delta T / T_o)}$$

where:
 Q = airflow rate, m³/s
 C_d = discharge coefficient for opening
 A_o = height from midpoint of linear opening to MP, m
 ΔT = indoor temperature, °C
 T_o = outdoor temperature, °C

Equation (27) applies when $T_i > T_o$. If $T_i < T_o$, replace T_o in the denominator with T_i and change $(\Delta T / T_o)$ in the numerator with $(T_o - T_i) / T_o$. An average temperature should be used for T_i if there is thermal stratification. If the building has more than one opening, the outlet and inlet areas are considered equal. The discharge coefficient C_d accounts for all losses (friction, such as surface drag and eddy losses).

Equation (27) also applies for naturally ventilated buildings, if one window or door maintains a large flowing continuously (90%) of the total opening area in the envelope. Here, the MP is at the mid-height of that opening, and A_o is equal to half the height of the opening. For this condition, the discharge coefficient is 0.65 (ASHRAE, and from the experiment data shown by the size of the opening, and air flow in the colder side flows through the bottom). Additional testing is required for counterflow infiltration, and the airflow coefficient can be calculated according to the following equation (Kirt and Kirtan 1985):

$$C_d = 0.65 \sqrt{1 - C_o^2}$$

If enough other openings are available, the airflow through the opening will be unidirectional, and entrance velocity V_e discharge coefficient $C_d = 0.95$ should then be used. Additional information on wind-driven airflow for natural ventilation can be found in Fanger and Dolan (1987).

ΔT	C_o
12	0.452
18	0.481
20	0.530

NOTE:
AS PER SNC Lavalin SPECIFICATION 04-00-SNL-K50-00020

PROJECT	QATALUM PROJECT SMELTER PROJECT	FILE	KR 18000. DISCHARGE COEFFICIENT			GRAVITEC VENTILATOR AIR-THERM INC. www.air-therm.com <small>10, 11, 12, 13, 14, 15, 16, 17, 18, 19, 20, 21, 22, 23, 24, 25, 26, 27, 28, 29, 30, 31, 32, 33, 34, 35, 36, 37, 38, 39, 40, 41, 42, 43, 44, 45, 46, 47, 48, 49, 50, 51, 52, 53, 54, 55, 56, 57, 58, 59, 60, 61, 62, 63, 64, 65, 66, 67, 68, 69, 70, 71, 72, 73, 74, 75, 76, 77, 78, 79, 80, 81, 82, 83, 84, 85, 86, 87, 88, 89, 90, 91, 92, 93, 94, 95, 96, 97, 98, 99, 100</small>
CLIENT	QATALUM 0-6126	DRAWN BY	ISSUED BY	APPROVED BY	DATE	
CONTRACT NUMBER	SNC Lavalin	SNC PROJ	07-5860	REV	00	

AIR-THERM KR2 COEFFICIENT OF DISCHARGE: SUPERIOR TO ANY OTHER LP VENT

Natural Thermodynamic Solutions

AIR-THERM

5. PROJECT EXPERIENCE

LIST OF SELECTED RECENT VENTILATION PROJECTS (CONFIDENTIAL)

ALCOA FJARDAAL		ICELAND
ALCOA MOSJOEN		NORWAY
ALUAR EXPANSION		ARGENTINA
STEEL COMPANY OF CANADA		LAKE ERIE STEEL
ALCOA		DESCHAMBAULT
ALCOA		DESCHAMBAULT CARBON
ALOUETTE SMELTER	PHASE 1	POINTE NOIR
ALOUETTE SMELTER	PHASE 2	POINTE NOIR POTLINE
ALOUETTE SMELTER	PHASE 2	POINTE NOIR CARBON
ALCAN		SEBREE KENTUCKY (2001)
ALCAN		ALMA QUE. (1998,1999,2000)
ALUAR (ARGENTINA) (4 PHASES)		PUERTO MADRYN, ARGENTINA
BOYNE SMELTER (1681 K VENTS)		GLADSTONE
ALOUETTE SMELTER	PHASE 1	POINTE NOIR
ALCAN		GRAND BAIE
ALCAN		LATERRIERE
ALCOA		BAIE COMEAU I
ALCOA		BAIE COMEAU II
ELKEM		QUEBEC
STEEL CO. OF CDA (STELCO)		NANTICOKE
STEEL CO. OF CDA		HAMILTON ONTARIO
STEEL CO. OF CDA		Quebec (several locations)
GERDAU STEEL		CAMBRIDGE ONTARIO
DOFASCO STEEL		HAMILTON ONTARIO
CHAPERRAL STEEL		TEXAS USA
RIO TINTO (QUEBEC IRON TITANIUM)		TRACY QUEBEC
ATLAS STAINLESS STEEL		SOREL QUEBEC
SYDNEY STEEL		CAPE BRETON NS
SMURFIT- STONE		NEW RICHMOND CANADA
WYMAN GORDON (TITANIUM)		GRAFTON MASSACHUSETTS
TROILUS		SEVERAL GLOBAL
EKA NOBEL (4 PROJECTS)		MAGOG QUEBEC
MAGNESIUM CANADA		HIGH RIVER, ALBERTA
GREAT LAKE CARBON		LACHUTE QUEBEC
IMPERIAL CHEMICAL		BECANOUR QUEBEC
GENERAL MOTORS		VARIOUS LOCATIONS
MICHELIN		VARIOUS LOCATIONS
PETRESA SA		BECANOUR QUEBEC
ENBRIDGE		WESTERN CANADA
COMINCO		TRAIL B.C.
SONATRAC		ALGERIA
COCA COLA		SEVERAL GLOBAL
CANEXUS CHEMICAL		SEVERAL GLOBAL

AIR-THERM INC.
 1 514 482 2067
www.air-therm.com
info@air-therm.com

APPENDIX V
PHOTOS OF SCANNING PROCESS



Scanning process: for scanning of 1 dimensional codes it was necessary to utilize a special bar code scanner.

These scanners proved to be much less rugged than the manufacturers sales personnel claimed that they would be and were affected by temperature and humidity and were prone to failure when dropped

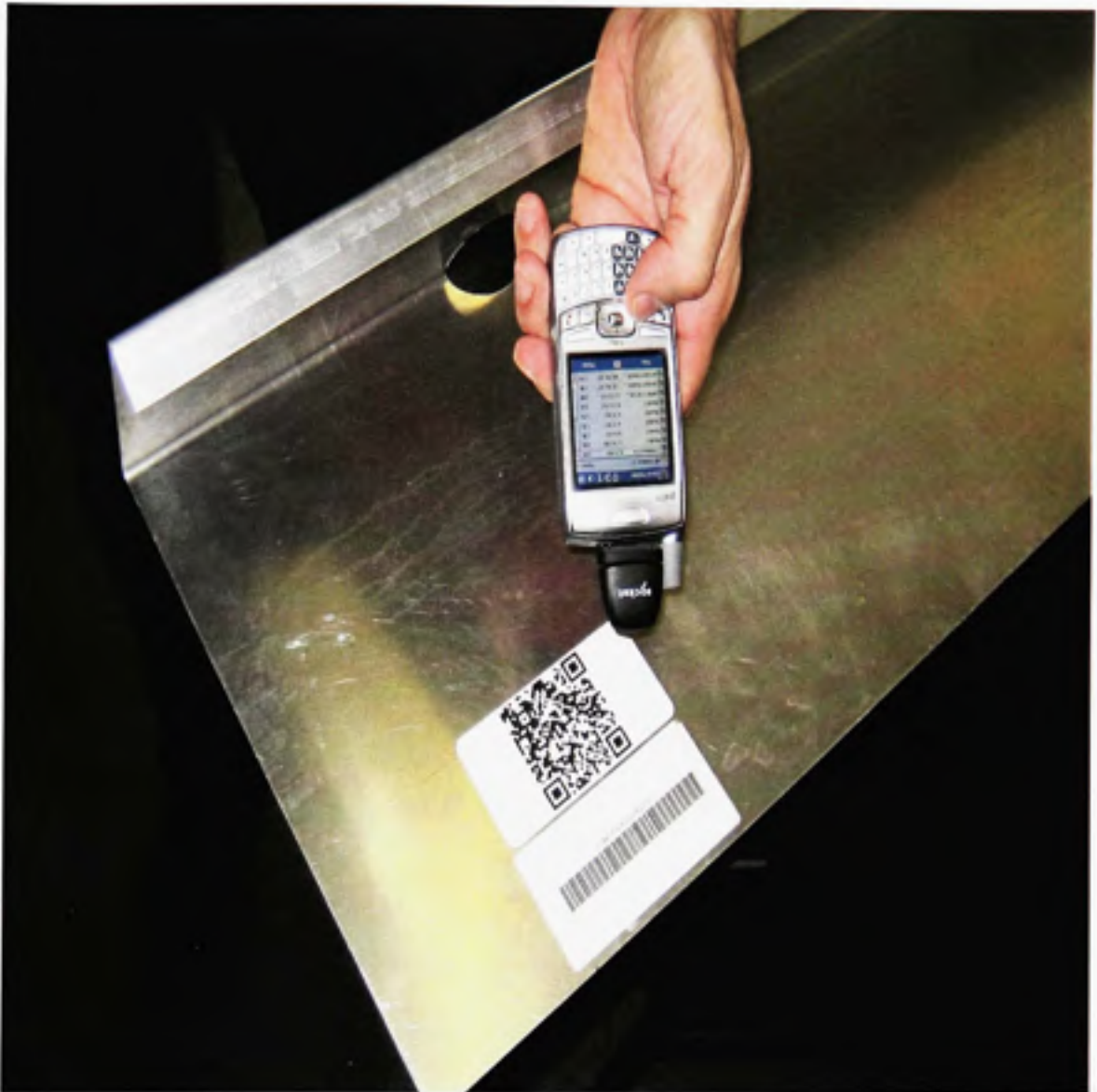

1 dimensional code versus 2 dimensional code

QR code held substantially more information than the 1 dimensional code and was accessible by utilizing the digital camera of the web enabled mobile handset



Capturing data from the 2 dimensional barcode did not require additional or peripheral equipment.



All components were designated with symbology code which meant complete traceability through all phases of the project lifecycle

Component: Ohio gear reducer 30:1 ratio



Louvre component being scanned and verified



Louvre components were fabricated with both qr-codes and the traditional marking as a fall back in case the middleware or other parts of the is experiment had technical issues: no such issues were encountered, however proper planning dictated a fall back position



Close up comparison of 1 dimensional to 2 dimensional barcode

REFERENCES

- American Society of Heating Refrigeration and Air Conditioning Engineers. 1985. *ASHRAE Handbook Chapter 22, Natural Ventilation*. (Atlanta).
- American Society of Heating Refrigeration and Air Conditioning Engineers. 1989. *ASHRAE/ANSI Standard 62.1-1989* (Atlanta)
- Bell LC, McCollough BG (1988) *Bar code application in construction*. Journal of Construction Engineering and Management, ASCE 114 (2) 156-162 p.
- Bernold LE (1990) *Testing bar code technology in construction environment*. Journal of Construction Engineering and Management, ASCE 116 (4) 643-55 p.
- Bushnell, Richard D. 1998. *Getting Started With Bar Codes: A Systematic Guide* Publisher: Cutter Information Corp; 2nd edition.
- Clodfelter GR. 1998. *Pricing Accuracy at Grocery Stores and Other Retail Stores Using Scanners*. International Journal of Retail & Distribution Management, Volume 26, Number 11, 1998, 412-420 p.
- Gantt HL. 1910. *Work, Wages and Profit, The Engineering Magazine*, New York.
- Holt NJ. 1999. *Ventilation of Potrooms in Aluminium Production*. The Mineral, Metal and Material society 1999 handbook, Atlanta 263-267 p.
- McKinsey and Company, New York, New York 1970. *Barcodes in Grocery Industry Phase I report*. 5 p.
- Porter ME. 1998. *Competitive Advantage*, Simon and Shuster, New York

- Randell B. 1994. (Newcastle upon Tyne University, department of computer science) *The origins of computer programming*. Annal of the History of Computing. IEEE. Vol 16 Issue 4 Winter 1994. 6-14 p.
- Rasdorf, William J. 1990. *Bar coding in construction engineering*. Journal of Construction Engineering and Management, v 116, n 2, Jun, 1990, p 261-280.
- Seideman,T. 1993. *Barcodes Sweep the World Wonders of Modern Technology*, Spring 1993.
- Shehab, T.Moselhi, O. 2005. *A multi-tier barcode based system for management of construction projects*. Proceedings, Annual Conference - Canadian Society for Civil Engineering, v 2005, Proceedings - 33rd CSCE Annual Conference 2005: 6th Construction Specialty Conference. CT-179-1-CT-179-8 p.
- Silver and Woodland. 1949. *USPTO Classifying Apparatus and Method Patent*. United States Patent 2612994.
- Toshiharu Ishibashi, Kenzo Obata, Toshio Morimoto, Hirotohi Nakamura. 2002. *Information-code-image capturing apparatus*. Denso Corporation United States Patent 6494375 .
- Tseng HP, Dzung RJ, Lin YC, Lin ST. 2005. *Mobile Construction Supply Chain Management Using PDA and Bar Codes*. Computer-Aided Civil and Infrastructure Engineering Volume 20 Issue 4 Page 242 - July 2005
- Winch, GM. 2002. *Managing Construction Projects*. Blackwell Publishing.