

ÉCOLE DE TECHNOLOGIE SUPÉRIEURE
UNIVERSITÉ DU QUÉBEC

MANUSCRIPT-BASED THESIS PRESENTED TO
ÉCOLE DE TECHNOLOGIE SUPÉRIEURE

IN PARTIAL FULFILLMENT OF THE REQUIREMENTS
FOR THE DEGREE OF DOCTOR OF PHILOSOPHY
Ph.D.

BY
Abderrahmane BENMIMOUNE

MOBILITY AND RESOURCE MANAGEMENT FOR 5G HETEROGENEOUS
NETWORKS

MONTREAL, APRIL 1, 2016



Abderrahmane BenMimoune, 2016



This Creative Commons licence allows readers to download this work and share it with others as long as the author is credited. The content of this work may not be modified in any way or used commercially.

BOARD OF EXAMINERS
THIS THESIS HAS BEEN EVALUATED
BY THE FOLLOWING BOARD OF EXAMINERS

Mr. Michel Kadoch, Thesis Supervisor
Department of Electrical Engineering at École de technologie supérieure

Mr. Bo Rong, Thesis Co-supervisor
Communications Research Centre Canada (CRC), Ottawa, Ontario, Canada

Mr. Stéphane Coulombe, Chair, Board of Examiners
Department of Software and IT Engineering at École de technologie supérieure

Mr. David Bensoussan, Member of the jury
Department of Electrical Engineering at École de technologie supérieure

Mr. Mohammed Lyakoubi, Independent External Evaluator
WIND Mobile, Toronto, Ontario, Canada

THIS THESIS WAS PRESENTED AND DEFENDED
IN THE PRESENCE OF A BOARD OF EXAMINERS AND THE PUBLIC
FEBRUARY 4, 2016
AT ÉCOLE DE TECHNOLOGIE SUPÉRIEURE

FOREWORD

" No two things have been combined together better than knowledge and patience. "

Muhammad (P.B.U.H)

ACKNOWLEDGMENTS

No matter what I say, I can't express my deep and sincere gratitude to Almighty GOD. Had it not been for his endless blessings, and continuous guidance throughout my life, this work would never have been done. Next comes my parents, the best gift I have ever received in life. The great father and the soulful mother. Without their satisfaction and prayers, I would not be who I am today. My gratitude is extended to my lovely wife for her support and great patience at all times.

In this opportunity, I would like to thank all those who assisted me during my Ph.D. studies. First and foremost, I would like to thank my supervisor Professor Michel Kadoch for the support, valuable advices, and help. Professor Kadoch always provided an open door to his office, for which I am really grateful. Working with him added a valuable experience to my life, which really deserves my full acknowledgements.

I would like to thank Dr. Bo Rong for the advices and valuable recommendations. Special thanks for my examiner committee: our guest examiner Dr. Mohammed Lyakoubi, Professor David Bensoussan, and the president Professor Stéphane Coulombe. Thanks for giving me the honor by being my Ph.D. committee, and for your valuable time and efforts.

Last, but by no means least, I would like to thanks my colleagues at the R&D department of Videotron, and all members of the LAGRIT Lab.

GESTION DE LA MOBILITÉ ET DES RESSOURCES DANS LES RÉSEAUX HÉTÉROGÈNES DE 5^{ème} GÉNÉRATION

Abderrahmane BenMimoune

RÉSUMÉ

La topologie classique, des réseaux cellulaires actuels, est une topologie en étoile, où les stations de base servent habituellement comme points de contrôle centraux. Celle-ci offre l'avantage d'une architecture simple tout en garantissant une meilleure qualité de service (QoS). Cependant, pour les réseaux futurs, c'est-à-dire de prochaine génération, cette topologie sera désavantageuse et difficile à utiliser en raison de l'insuffisante disponibilité d'accès au réseau. Le réseau à topologie hybride sera donc naturellement le futur réseau d'accès mobile, qui peut aider à surmonter les difficultés et les défis actuels et futurs d'une manière efficace. Ainsi, la technologie de relais peut jouer un rôle prépondérant pour offrir ce type de topologie dans le réseau cellulaire.

Aujourd'hui, selon les dernières normes du réseau LTE-A, l'organisme 3GPP supporte la technologie de relais à un seul saut, dans lequel le lien d'accès radio entre la station de base et les utilisateurs est relié par une seule station de relais. Toutefois, avec l'aide des relais à multi-saut, la liaison radio entre la station de base et les utilisateurs peut être étendue à plus de deux sauts afin d'améliorer, à la fois, la capacité et la couverture du réseau. Cela pourrait être expliqué par la réduction du trajet en raison de l'emploi de plusieurs sauts pour transmettre des données depuis/vers la station de base correspondante. Néanmoins, l'utilisation d'un système de relais à multi-saut exige plus de ressources radio pour transmettre des données à travers les différents liens. Également, plus d'interférences sont créées en raison du nombre élevé de transmissions simultanées dans le réseau. De nouveaux mécanismes pour la gestion de la mobilité et des ressources sont donc nécessaires pour augmenter la capacité totale du réseau tout en garantissant une meilleure qualité de service.

Dans le cadre de la première partie de cette thèse, nous avons étudié conjointement le problème de sélection de relais et l'allocation des ressources radio, dans lequel nous abordons principalement la question de choisir la façon dont la bande passante devrait être partagée entre les différents liens (direct, backhaul et le lien d'accès) dans les réseaux de relais à multi-saut. Dans un tel réseau, l'allocation des ressources joue un rôle essentiel puisqu'elle gère l'accès au canal, à la fois, dans le domaine du temps et des fréquences, et détermine ainsi comment les ressources sont allouées pour les différents liens. La solution proposée applique les concepts de la technique d'optimisation non-linéaire, et la méthode d'itération heuristique. Tout d'abord, la formulation du problème d'allocation des ressources et la sélection de relais a été présentée pour fournir un cadre intégré pour les réseaux de relais à multi-saut. Ensuite, une solution analytique du problème a été présentée à travers la technique d'optimisation non-linéaire, en conséquence, un algorithme itératif à deux étapes a été présenté pour résoudre le problème d'allocation des ressources et la sélection de relais conjointement dans les réseaux de relais à multi-saut. Au demeurant, la première étape propose une solution analytique pour cerner le problème d'allocation des ressources, qui

prend en compte le compromis entre l'optimalité et la complexité de l'architecture du relais à multi-saut; la deuxième étape présente une stratégie heuristique pour la sélection de relais qui considère la charge des stations de relais.

La deuxième partie de ce travail traite principalement le problème de la mobilité dans les réseaux à relais multi-saut. En plus de la question de l'allocation des ressources, le problème de sélection de relais est étudié du point de vue de la couche réseau. Par conséquent, cette partie ajoute au problème la question de la sélection de route de liaison radio. Comme une alternative de l'algorithme heuristique développé dans la précédente partie, le travail présenté décrit le développement et l'évaluation d'un système de sélection de relais basé sur le processus de Markov qui considère la charge des stations de relais et des liaisons radio existantes en vue d'améliorer la mobilité et la performance. Tout d'abord, la formulation du problème d'allocation des ressources et la sélection de relais est présenté; selon un modèle mathématique basé sur le processus Markov lequel est conçu pour résoudre le problème de sélection de relais de manière décentralisée et rendre ainsi le processus de sélection plus simple. La solution proposée pour la sélection de relais a pour objectif de maintenir le débit et d'assurer une continuité de service pour tous les terminaux mobiles connectés dans le réseau.

La troisième partie de ce travail permet de résoudre conjointement les problèmes de contrôle d'admission et d'énergie dans un réseau hétérogène composé de plusieurs petites cellules. Comparativement aux deux parties précédentes, le système est étendu d'un réseau de relais à multi-saut à un réseau hétérogène à petites cellules. Par conséquent, cette partie se concentre uniquement sur le problème au niveau des liens d'accès en supposant que la capacité des liens de backhaul est assez grande pour ne pas être congestionnée. Cette partie traite principalement le problème d'admission pour maximiser le nombre d'utilisateurs admis dans un système surchargé, tout en minimisant l'énergie d'émission. Premièrement, le problème est formulé en tenant en considération les exigences de qualité de service des utilisateurs. Deuxièmement, un mécanisme d'association d'utilisateurs basé sur le diagramme Voronoi est proposé pour maximiser le nombre d'utilisateurs admis dans le système par rapport à la QoS et les contraintes de la capacité. Enfin, un algorithme à deux étapes a été présenté pour résoudre conjointement les problèmes de contrôle d'admission et d'énergie dans un réseau hétérogène à petites cellules. En particulier, la première étape propose une politique de contrôle d'admission dynamique qui considère la QoS et la charge des petites cellules, tout en aidant à maintenir le balancement de charge dans le réseau. la seconde étape présente une stratégie adaptative de contrôle d'énergie qui prend en compte à la fois la distribution des utilisateurs et la densité des petites cellules dans des réseaux hétérogènes.

Les solutions proposées sont évaluées à travers différents scénarios de simulation et les résultats numériques sont présentés et comparés avec les travaux correspondants dans la littérature.

Mots-clés: Réseaux LTE/LTE-A, Relais à multi-saut, Allocation des ressources, Sélection de relais, Contrôle d'admission, Contrôle d'énergie, Optimisation non-linéaire, Théorie de la décision de Markov, et Diagramme de Voronoi.

MOBILITY AND RESOURCE MANAGEMENT FOR 5G HETEROGENEOUS NETWORKS

Abderrahmane BENMIMOUNE

ABSTRACT

The conventional topology of current cellular networks is a star structure, where central control points usually serve as base stations (BSs). This provides the advantage of simplicity while still providing quality of service (QoS). For next-generation networks, however, this topology is disadvantageous and difficult to use due to the insufficient availability of network access. The hybrid topology radio network will thus naturally be the future mobile access network that can help to overcome current and future challenges efficiently. Therefore, relay technology can play an important role in a hybrid cellular network topology.

Today, with the recent long-term evolution-advanced (LTE-A) standards, the 3rd Generation Partnership Project (3GPP) supports a single-hop relay technology in which the radio access link between the BS and users is relayed by only one relay station (RS). With the help of multi-hop relay, however, the radio link between the BS and users can be extended to more than two hops to improve the coverage and network capacity. Multiple hops to transmit data to and from the corresponding BS results in the reduction of path loss. However, using a multi-hop relay system requires more radio resources to transmit data through different hops. More interference is also created due to a greater number of simultaneous transmissions in the network. New mobility and resource management schemes are thus important for achieving a high QoS while increasing the whole network capacity.

In the first part, the problem of relay selection and radio resource allocation is studied, and choosing how the bandwidth should be shared between direct, backhaul, and access links in multi-hop relay networks is discussed. In such a network, resource allocation plays a critical role because it manages channel access in both time and frequency domains and determines how resources are allocated for different links. The proposed solution includes a nonlinear programming technique and a heuristic method. First, the problem formulation of resource allocation and relay selection is presented to provide an integrated framework for multi-hop relay networks. Second, an analytical solution to the problem is presented using a nonlinear programming technique. Finally, an iterative two-stage algorithm is presented to address the joint resource allocation and relay selection problem in multi-hop relay networks under backhaul and capacity limitation constraints. In particular, the first stage proposed a fast approximation analytical solution for a resource allocation algorithm that takes into account the trade-off between the optimality and the complexity of the multi-hop relay architecture; the second stage presented a heuristic relay selection strategy that considers the RS load and helps to keep the relay from being overloaded is proposed.

In the second part, the mobility problem in downlink multi-hop relay networks is addressed. In addition to the resource allocation issue, the relay selection problem is studied from a network layer perspective. Therefore, this part includes the issue of radio path selection. As

an alternative to the heuristic algorithm developed in the previous part, the presented work describes the development and evaluation of a relay-selection scheme based on a Markov decision process (MDP) that considers the RS load and the existing radio-link path to improve handoff performance. First, the problem formulation of resource allocation and relay selection is presented. Second, an MDP mathematical model is developed to solve the relay selection problem in a decentralized way and to make the selection process simple. This relay selection scheme has the objective of maintaining the throughput and ensuring seamless mobility and service continuity to all mobile terminals while reducing the handoff frequency and improving handoff performance.

In the third part, the admission and power control problem of a general heterogeneous network (HetNet) consisting of several small cells (SCs) is solved. Compared to the first two parts of this work, the system is expanded from a multi-hop RS to a general SC context. This part therefore focuses only on the access link problem, assuming the capacity of the SC backhaul links are large enough not to be bottlenecks. This part mainly deals with the problem of how to maximize the number of admitted users in an overloaded system while minimizing the transmit power given a certain QoS level. First, the problem is formulated to address concerns about QoS requirements in a better way. Second, a Voronoi-based user association scheme for maximizing the number of admitted users in the system under QoS and capacity limitation constraints is proposed to find near-optimal solutions. Finally, a two-stage algorithm is presented to address the joint admission and power control problem in a downlink heterogeneous SC network. In particular, the first stage proposes a dynamic call admission control policy that considers the SC load and call-level QoS while also helping to keep the system from being overloaded. The second stage presents an adaptive power allocation strategy that considers both user distribution and the density of SCs in HetNets.

Finally, the proposed solutions are evaluated using extensive numerical simulations, and the numerical results are presented to provide a comparison with related works found in the literature.

Keywords: LTE/LTE-A Networks, Multi-hop Relay, Resource Allocation, Relay Selection, Admission Control, Power Control, Nonlinear Programming, Markov Decision Theory, Voronoi Diagram.

TABLE OF CONTENTS

	Page
INTRODUCTION	1
CHAPITRE 1 Relay Technology for 5G Networks	13
1.1 Abstract	13
1.2 Introduction	13
1.3 Relay classification	15
1.3.1 Classification based on layers	15
1.3.2 Classification based on duplexing schemes	16
1.3.3 Classification based on resources assignment	17
1.3.4 3GPP classification	18
1.4 Potential benefits of relaying	18
1.4.1 Relay to improve channel reliability	19
1.4.2 Relay to improve system throughput	19
1.4.3 Relay to improve service continuity	20
1.4.4 Relay for offloading and load sharing	21
1.4.5 Relay to reduce operational costs	21
1.5 Relay deployment strategies in 5G networks	22
1.5.1 Multi-hop relay	23
1.5.2 Mobile relay	24
1.5.3 Heterogeneous relay	24
1.5.4 Relay-assisted D2D communication	25
1.5.5 Multiple backhaul relay	26
1.6 Challenges	27
1.6.1 Radio resource allocation	27
1.6.2 Power control	29
1.6.3 Admission control	29
1.6.4 Relay selection	30
1.6.5 Handoff	31
1.6.6 Routing	32
1.7 Methodology Tools	32
1.7.1 Nonlinear Programming Theory	33
1.7.2 Markov Decision Theory	34
1.7.3 Voronoi Diagram	35
1.8 Conclusion	37
CHAPITRE 2 Dynamic Joint Resource Allocation and Relay Selection in Urban Sparse for 5G Multi-hop Relay Systems	39
2.1 Abstract	39
2.2 Introduction	40
2.2.1 Related Works	42
2.2.2 Our Contribution	44

2.3	System Model	44
2.4	Problem Formulation	45
2.4.1	Resource Allocation and Relay Selection Framework	46
2.4.2	Performance Measurements.....	52
2.4.2.1	Average throughput:	52
2.4.2.2	Fairness index:	53
2.5	Proposed Resource Allocation and relay Selection Algorithm.....	53
2.5.1	Stage 1: Fast Approximation Algorithm for Resource Allocation	53
2.5.2	Stage 2: Greedy Algorithm for Relay Selection	55
2.6	Numerical Results And Discussion	56
2.7	Conclusion	64
CHAPITRE 3	MDP-based Joint Path Relay Selection in 5G Multi-hop Relay Networks.....	65
3.1	Abstract.....	65
3.2	Introduction.....	66
3.2.1	Related Works.....	67
3.2.2	Our Contribution.....	69
3.3	System Model	69
3.4	Problem Formulation	70
3.4.1	Relay Selection Problem Formulation	71
3.4.2	Performance Measurements.....	73
3.4.2.1	Average throughput	73
3.4.2.2	Handoff delay.....	73
3.5	Proposed relay-Selection Scheme.....	74
3.5.1	The state \mathcal{S}	75
3.5.2	The action \mathcal{A}	75
3.5.3	The reward \mathcal{R}	76
3.5.4	The probability \mathcal{P}	77
3.5.5	The discount factor γ	78
3.5.6	State transition diagram of MDP	79
3.5.7	Matrix of the Markov chain	80
3.6	Relay-Selection Algorithm	80
3.7	Numerical Results And Discussion	81
3.8	Conclusion	90
CHAPITRE 4	User Association-Based Joint Admission and Power Control for Heterogeneous Wireless Networks.....	91
4.1	Abstract.....	91
4.2	Introduction.....	92
4.3	System Model	95
4.4	Problem Formulation and proposed scheme.....	97
4.4.1	Admission Control.....	97
4.4.2	Power Control.....	98
4.4.3	Voronoi-based User Association Scheme.....	99

4.5	Admission and Power Control Algorithm	103
4.6	Simulation And Results	104
4.7	Conclusion	111
	CONCLUSION.....	113
	BIBLIOGRAPHY.....	117

LIST OF TABLES

		Page
Table 0.1	Specification of different elements in a heterogeneous network	2
Table 1.1	Summary of Relay Classifications.....	18
Table 2.1	Summary of important symbols.....	47
Table 2.2	Simulation parameters	58
Table 3.1	Simulation parameters	81
Table 3.2	Video application parameters	82
Table 4.1	Simulation parameters	105

LIST OF FIGURES

		Page
Figure 0.1	Heterogeneous network architecture.....	1
Figure 0.2	Relay architecture: (a) single-hop relay; (b) multi-hop relay.	2
Figure 0.3	Structure of the thesis.....	10
Figure 1.1	TDD and FDD schemes	16
Figure 1.2	In-band and out-band scenarios	17
Figure 1.3	Spatial diversity for reliability improvement.....	19
Figure 1.4	Spatial diversity for resource aggregation	20
Figure 1.5	Relay for coverage extension.....	20
Figure 1.6	Relay for traffic load-balance	21
Figure 1.7	Hybrid topology with relay in 5G networks	22
Figure 1.8	Multi-hop relay deployment	23
Figure 1.9	Mobile relay deployment	24
Figure 1.10	Heterogeneous relay deployment.....	25
Figure 1.11	Relay-assisted D2D deployment.....	26
Figure 1.12	Multiple backhaul relay deployment	27
Figure 1.13	Options of resource allocation in multi-hop relay networks.....	28
Figure 1.14	Handoff scenarios in relaying networks	31
Figure 1.15	Example of routing in multi-hop relay networks.....	32
Figure 1.16	Example of a MDP state-transition diagram for a light switch system	34
Figure 1.17	Example of Voronoi diagram.....	36
Figure 2.1	LTE Relay Architecture: (a) single-hop relay (b) multi-hop relay	40
Figure 2.2	Network system model	45

Figure 2.3	Simulation environment.....	57
Figure 2.4	Average achieved throughput for different architectures	58
Figure 2.5	Fairness index for different architectures	59
Figure 2.6	Average achieved throughput	60
Figure 2.7	Average achieved throughput per user density	61
Figure 2.8	Total execution time vs. the number of stations	62
Figure 2.9	Average achieved throughput per number of hops.....	62
Figure 2.10	Fairness index per type of connection link	63
Figure 3.1	Network relay architecture: (a) Single-hop relay (b) Multi-hop relay.....	66
Figure 3.2	Network system model	70
Figure 3.3	Handoff scenarios in multi-hop relay architecture: (a) Intra-cell handoff (b) Inter-cell handoff.....	74
Figure 3.4	MDP state-transition diagram.....	79
Figure 3.4	Network simulation model.....	82
Figure 3.6	UE throughput distribution ($\gamma = 0.1$).....	83
Figure 3.7	UE throughput distribution ($\gamma = 0.5$).....	83
Figure 3.8	UE throughput distribution ($\gamma = 0.9$).....	84
Figure 3.9	Packet loss ratio ($\gamma = 0.1$).....	85
Figure 3.10	Packet loss ratio ($\gamma = 0.5$).....	86
Figure 3.11	Packet loss ratio ($\gamma = 0.9$).....	86
Figure 3.12	Average handoff delay ($\gamma = 0.1$).....	87
Figure 3.13	Average handoff delay ($\gamma = 0.5$).....	88
Figure 3.14	Average handoff delay ($\gamma = 0.9$).....	88
Figure 3.15	Number of inter-cell and intra-cell handoffs per discount and joint factor parameters.....	89

Figure 4.1	Network system model	96
Figure 4.2	Network simulation model.....	104
Figure 4.3	Voronoi diagram for a heterogeneous wireless network	106
Figure 4.4	User association for a heterogeneous wireless network	106
Figure 4.5	System throughput per small cell concentration.....	107
Figure 4.6	Admitted users per small cell concentration.....	108
Figure 4.7	Blocking probability per algorithm.....	109
Figure 4.8	Average maximum power transmission per small cell concentration	110

LIST OF ALGORITHMS

	Page
Algorithm 2.1 Resource allocation and relay selection algorithm.....	56
Algorithm 3.1 Relay selection algorithm.....	Erreur ! Signet non défini. 0
Algorithm 4.1 User association-based admission and power control algorithm.....	103

LIST OF ABBREVIATIONS

3GPP	Third Generation Partnership Project
5G	Fifth Generation
BS	Base Station
CBR	Continuous Bit Rate
CDF	Cumulative Distribution Function
CSI	Channel State Information
D2D	Device-to-Device
eNB	evolved Node B
FDD	Frequency Division Duplex
HetNet	Heterogeneous Network
IoT	Internet of Things
ISM	Industrial, Scientific, and Medical
JPAC	Joint Admission Power Control
KKT	Karush–Kuhn–Tucker
LTE	Long-Term Evolution
LTE-A	Long-Term Evolution Advanced
MAC	Media Access Control
MANET	Mobile Ad hoc Network
MC	Macro Cell
MDP	Markov Decision Processes
M-UE	Macro-User Equipment
OFDMA	Orthogonal Frequency-Division Multiple Access
PF	Proportional Fair
PMP	Point-to-MultiPoint
PRB	Physical Resource Block
QoS	Quality of Service
RAN	Radio Access Network
RRH	Remote Radio Head

RS	Relay Station
RSS	Received Signal Strength
RSS-EP	Received Signal Strength- Equal Power
R-UE	Relay-User Equipment connected to Macro
SC	Small Cell
SINR	Signal to Interference plus Noise Ratio
SIR	Signal to Interference Ratio
TDD	Time Division Duplex
UE	User Equipment
WiFi	Wireless Fidelity

LIST OF SYMBOLS AND UNITS OF MEASUREMENTS

%	Percent Sign
dBm	Decibel-milliwatt
m/sec	Metre per second
Mbps	Megabits per second
MHz	Megahertz
ms	Millisecond
$\gamma_{i,j}$	Allocated bandwidth from station i to user j
$\delta_{i,k}$	Allocated bandwidth from station i to child relay station k
$r_{i,j}^A$	Achieved throughput at user j from station i
$r_{i,k}^B$	Achieved throughput at station k from station i
$A_{i,j}$	Spectral efficiency on access link between station i and user j
$B_{i,k}$	Spectral efficiency on backhaul link between station i and k
C_i	Transmission capacity of a station i
m_i	Set of child relay stations backhauled to the station i
n_i	Set of users served by the station i
N_s	Total number of station (BS, RS, SC) in the region
M	Total number of users in the area
$L(.)$	Lagrangian function
λ_i	Lagrange multiplier corresponding to capacity constraint
r_j	Achieved throughput by user j
P_i^{max}	The maximum transmission power level of station i
PL_j^i	The path loss between station i and user j
$P_{i,j}$	The received power level at the user j from station i

INTRODUCTION

The demand for mobile services is currently exploding, which poses major challenges to mobile operators in supporting these high-capacity requirements and improving the quality of service (QoS). In order to meet throughput demands and uniformly distribute the capacity of a cellular network, the 3rd Generation Partnership Project (3GPP) introduced long term evolution-advanced (LTE-A) networks that include several new capabilities. One of the most significant new functionalities is heterogeneous networks (HetNets) (Damnjanovic et al., 2011), a new design paradigm that provides enhanced capacity and extended coverage for macro cells (MCs) by deploying several low-power nodes within its coverage. In a HetNet, various small cells (SCs) are distributed throughout the macro-cell network, as shown in Figure 0.1; these include a remote radio head (RRH), pico cells, femtocells, and relay stations (RSs) (Damnjanovic et al., 2011). The backhaul technologies used to connect the radio access network of SCs to the core network include optical fiber, microwave, xDSL, and LTE backhaul.

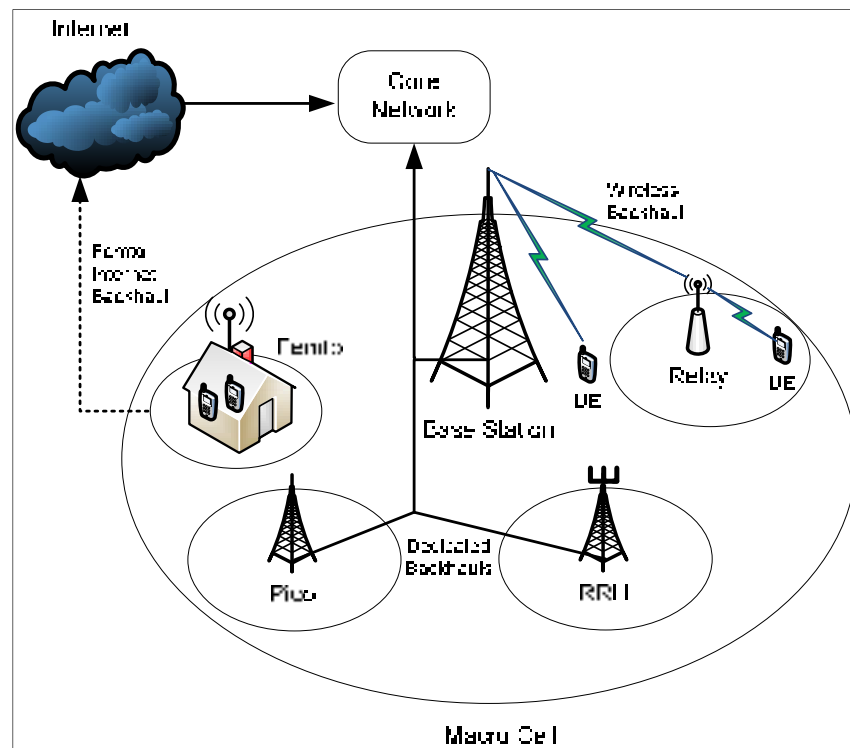


Figure 0.1 Heterogeneous network architecture

The table below shows the principal node types of a HetNet and their characteristics.

Table 0.1 Specification of different elements in a heterogeneous network

Node Type	Indoor/Outdoor	Transmit power	Number of users	Backhaul
Macro	Outdoor	46 dBm	200–1000+	S1 Interface
Femto	Indoor	< 23 dBm	4–16	Internet IP
Pico	Indoor or Outdoor	23–30 dBm	32–100	X2 Interface
RRH	Indoor or Outdoor	46 dBm	200–1000+	Fiber
Relay	Outdoor	30 dBm	32–100	Wireless

Our study investigates RSs that can be used to extend the LTE-A radio access network in coverage hole, cell edge, and isolated area scenarios. In fact, relaying is considered to be one of the key functionalities of LTE-A future releases to improve the cell-edge user throughput and to extend coverage to new areas via flexible and easy deployment (Parkvall, Furuskar, & Dahlman, 2011). With relaying, the user equipment (UE) connects to the network via an RS that is wirelessly connected to a base station (BS) using the LTE radio interface technology (Parkvall et al., 2011). The BS or evolved Node B (eNB) may serve one or several relays in addition to directly serving the macro UE (M-UE) (3GPP, 2012a). Figure 0.2 illustrates how RSs can be integrated into an LTE-A network (single-hop and multi-hop scenarios).

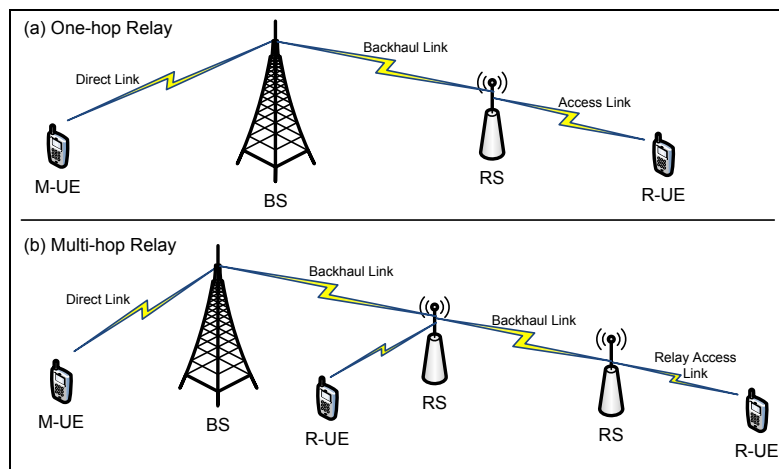


Figure 0.2 Relay architecture: (a) single-hop relay; (b) multi-hop relay

In the current 3GPP standard (3GPP, 2012b), LTE-A is limited to a single-hop relay scenario, a backhaul link from the BS to the RS, and an access link from the RS to the relay UE (R-UE) (Figure 0.2-a). Consequently, an RS is unable to use a different RS as its donor station. An RS has to directly connect to the BS but without passing through several hops. The principal reason for choosing this architecture is to reduce system complexity and to minimize the impact on the existing LTE-A standard. However, multi-hop relaying (Figure 0.2-b) has been identified as a valuable wireless paradigm in the future releases of LTE, particularly for sparse urban area deployment scenarios in which it is able to improve coverage and network capacity due to the reduction of path loss by replacing the direct low-quality link between the BS and UE with multiple high-quality links through one or multiple RSs.

Motivation

Network operators are interested in deploying as many RSs as possible with two main objectives: (i) to improve outdoor coverage and (ii) to increase network capacity. Some research groups have focused on the single-hop relay network architecture to demonstrate the benefits of relaying and to solve several problems in the traditional cellular macro-cell networks, such as:

- increasing the achieved throughput for cell-edge users;
- reducing the power consumption of users; and
- reducing the cost/bit delivered to address the explosive growth in data demand.

While the majority of the existing literature studies the single-hop case because it is simpler than the multi-hop case, some studies have shown that a better performance in terms of coverage and network capacity can be achieved by supporting multi-hop relay architecture. In fact, multi-hop relaying can provide great advantages by extending coverage to mountainous and sparsely populated areas. However, using multi-hop relay architecture requires more resources to transmit data through different hops, which leads to longer delays and significant impact on QoS.

Furthermore, the potential gain in coverage and capacity of multi-hop relay networks is highly dependent on mobility and resource management schemes, a topic that draws significant attention from the scientific community. We believe that much research has yet to be done on this topic.

Moreover, mobility and resource management in such a complex environment is a big challenge as increasing the number of links makes the problem difficult to tackle and the existing solutions are not suitable for practical application due to the complexity of the problem.

Problem Statement

Mobility and resource management of LTE-A small cells networks has been widely studied in different scenarios. Specifically regarding relay networks, previous studies focused on solving this problem in different scenarios, such as downlink or uplink data traffic single-cell or multi-cell networks using different constraints, such as data throughput, delay, mobility, and traffic awareness, for the relay networks. However, most of the existing literature studies the single-hop case because it is simpler than studying the multi-hop case. Thus, the major problems encountered in this context are related to mobility and resource management.

The specific issues that need to be addressed with the introduction of a multi-hop RS in an LTE-A network are throughput slow down and service interruption; imbalance and network overload (which lead to users not being fairly treated); higher power consumption; and the computational complexity of bandwidth allocation. Following, we explain each of these problems.

Throughput slow down: RSs are considered to be one of the key functionalities of LTE-A to improve the cell-edge user throughput and to extend coverage to new areas via flexible and easy deployment. However, poor mobility and resource management schemes will potentially have great impact on achieved user throughput, implying deterioration of the QoS.

Service interruption: The deployment of RSs and multi-hop relays in particular will increase the handoff delay and frequency as they offer users more opportunities to be handed over. Thus, ensuring seamless mobility and service continuity to all mobile terminals in this context is a challenging issue that requires a well-designed solution.

Imbalance and network overload: Usually, the presence of RSs will help operators keep the system from being overloaded. However, inappropriate resource management—especially for backhaul links—will potentially lead to asymmetric cells where some cells will be highly loaded and others will be lightly loaded. In addition, the backhaul links should be carefully designed to avoid a network bottleneck.

Unfairness among the users: The conventional method of relay selection is high throughput-oriented and is based on the instantaneous channel condition between relay and user. In this case, the network will suffer from much greater unfairness among users, particularly among those connected directly to a BS and those connected through a multi-hop relay.

High power consumption: The design of traditional cellular networks tends to maximize capacity and coverage, which can potentially lead to solutions where energy efficiency drops. The RSs and SCs in general reduce the energy consumption on the user side by bringing the radio access closer to the end user; however, on the operator side, the energy spent by the infrastructure may increase by increasing the number of RSs, implying high operational costs.

Computational complexity: Most of the existing work on multi-hop relay networks is not suitable for practical applications due to the complexity of the problem, particularly when the network concerned is large. Therefore, reducing the computational complexity is important for algorithm design.

The problems listed above are directly or indirectly related to each other, and solving them will have an unintended direct impact on other issues. Thus, these problems should be addressed jointly, which can potentially result in obtaining global optimality. In this case, we

are trading off optimality for simplicity and practicality by specifying and solving the problems as an independent group of problems.

Objectives

The main goal behind this work is to solve the problems discussed in the previous section. Therefore, the first main objective is to develop an efficient resource utilization scheme that enables the operator to attempt a dynamic bandwidth allocation mechanism instead of the static one. In addition, this dynamic model should allocate the network bandwidth resources to maximize user satisfaction while reducing computational complexity.

The second main objective is to develop a novel efficient handoff algorithm based on a new relay-selection strategy to improve handoff performance while ensuring seamless mobility and service continuity to all mobile terminals.

Finally, the last main objective of this work is to develop models that motivate the SCs to behave cooperatively in a way that serves the whole network interest by maximizing the number of users admitted into the system while reducing power consumption.

The resulting work should solve the following main issues:

- how to maximize total user satisfaction in the system;
- how the bandwidth should be shared between different links;
- how to reduce the handoff frequency in multi-hop relay networks;
- how to improve handoff performance in the system;
- how to maximize the number of users admitted into the system; and
- how to reduce the transmission power of SCs.

These issues will be solved by developing different models using different theories and working environments. However, the achievements of the proposed models will be compared to those of others found in the literature.

Thesis Outline

The thesis is an article-based dissertation, which organized as follows. Chapter 1 provides an overview of the relay technology being considered for future 5G network. The chapter is divided into two parts; the first part introduces and compares different relay types in LTE-A/5G networks and presents the relay advantages. The second part presents deployment scenarios in which the introduction of relay technology is potentially useful, as well as some associated challenges, such as resource allocation; power and admission control; relay selection; and routing. In addition, the definitions of the proposed tools and theories to be used in this work to achieve the aforementioned objectives are presented.

Chapter 2 addresses the problems of relay selection and radio resource allocation and mainly discusses the issue of deciding how the bandwidth should be shared between direct, backhaul, and access links in multi-hop relay networks. In such networks, resource allocation plays a critical role because it manages channel access in both time and frequency domains and determines how resources are allocated for different links. The proposed solution applies a nonlinear programming technique and a heuristic method. The problem formulation of resource allocation and relay selection presented in Section 2.4 provides an integrated framework for multi-hop relay networks. An analytical solution can be obtained by applying Lagrangian and Karush–Kuhn–Tucker (KKT) conditions, assuming a user-relay association scheme is already known. However, in such cases, mobile users are “mobile” by definition; therefore, user-relay association is continuously changing. Section 2.5 presents an iterative two-stage algorithm to address the joint resource allocation and relay selection problem in multi-hop relay networks under backhaul and capacity limitation constraints. In particular, the first stage proposes a fast approximation analytical solution for a resource allocation algorithm that takes into account the trade-off between the optimality and the complexity of the multi-hop relay architecture. The second stage presents a heuristic relay selection strategy that considers the RS load and helps to keep the relay from being overloaded.

Recalling the list of objectives presented in the previous section, the contribution of this part lies in solving the following issues:

- how to formulate the resource allocation problem in multi-hop relay networks;
- how to maximize total user satisfaction in the system;
- how the bandwidth should be shared between different links;
- how to jointly address the problem of relay selection and resource allocation; and
- how to achieve low computational complexity in such a large network.

In Chapter 3, the work mainly addresses the mobility problem in downlink multi-hop relay networks. Compared to the work presented in the Chapter 2 and in addition to the resource allocation issue, the relay selection problem is studied from a network layer perspective. Therefore, this part adds the issue of radio path selection to the problem. As an alternative to the heuristic algorithm developed in Chapter 2, Chapter 3 describes the development and evaluation of an RS scheme based on a Markov decision process (MDP) that considers the RS load and the existing radio-link path to improve handoff performance. The problem formulation of resource allocation and relay selection is presented in Section 3.4 and consists of two sub-problems. The resource allocation sub-problem is solved in Chapter 2; to solve the relay selection sub-problem in a decentralized way and to make the selection process simple, an MDP mathematical model is developed in Section 3.5. The objective of the MDP-based relay selection scheme is to maintain the throughput and to ensure seamless mobility and service continuity to all mobile terminals while reducing the handoff frequency and improving handoff performance. The performance of our design was evaluated using various parameter settings and was compared to the conventional disjoint-path algorithm.

From the list in Section 1.3, this part solves the following issues:

- how to model a mathematical framework for the relay selection process;
- how to reduce the handoff frequency in multi-hop relay networks;
- how to improve handoff performance in the system; and
- how to address the relay selection problem while considering the existing radio-link path.

Chapter 4 solves the admission and power control problem for a general HetNet consisting of several SCs. Compared to the two previous parts of the work, the system is expanded from a multi-hop RS to a general SC context. Thus, this part focuses only on the access link problem, assuming the capacity of the SC backhaul links are large enough not to be bottlenecks. The presented work mainly deals with the problem of how to maximize the number of admitted users in an overloaded system while minimizing the transmit power given a certain QoS level. To address concerns regarding QoS requirements in a better way, Section 4.4 details how the problem is formulated and how the proposed scheme is deployed in a HetNet, which provides a more efficient solution compared to the traditional static scheme. However, solving such an optimization problem is difficult, especially for large-scale SC networks. Therefore, a Voronoi-based user association scheme for maximizing the number of admitted users in the system under QoS and capacity limitation constraints is proposed to find near-optimal solutions. Section 4.5 presents a two-stage algorithm to address the joint admission and power control problem in a downlink heterogeneous SC network. In particular, the first stage proposes a dynamic call admission control policy that considers the SC load and call-level QoS, while also helping to keep the system from being overloaded. The second stage presents an adaptive power allocation strategy that considers both user distribution and the density of SCs in HetNets.

Thus, the achievements of this part solve the following issues:

- how to maximize the number of users admitted in the system;
- how to reduce the transmission power of SCs;
- how to apply the user assignment scheme to the different stations available in the system; and
- how to balance the traffic load on the different stations in the system.

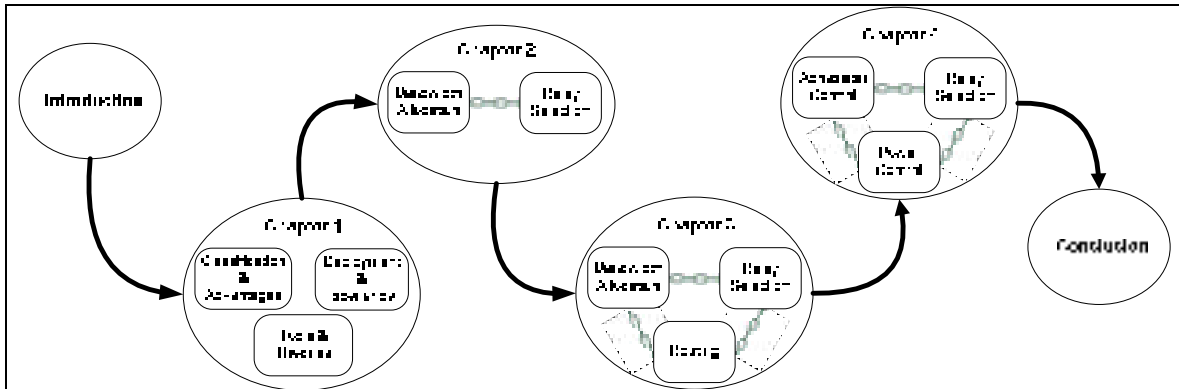


Figure 0.3 Structure of the thesis

Summary of Achievements and Novelty

The work in Chapter 2 provides a joint solution for resource allocation and relay selection in a multi-hop relay network. The implemented technique results in a near-optimal solution by combining a fast analytical approximation with a heuristic method. The proposed solution maximizes the total user satisfaction by jointly selecting the best RS for each user and optimally allocating the resources to each station such that a low computational complexity can be achieved at the cost of a reasonable performance loss in terms of throughput and fairness.

Chapter 3 proposes the development and evaluation of a relay-selection scheme for multi-hop relay networks. A new mathematical framework model based on an MDP is proposed for the relay selection strategy that considers the RS load and the existing radio-link path to improve handoff performance. Specifically, the proposed scheme minimizes inter-cell handoff, packet loss, and handoff delay at the cost of a reasonable performance loss in terms of throughput compared to the disjoint-path solution.

In Chapter 4, the work provides a new technique based on a Voronoi diagram for a joint admission and power control scheme in a multi-hop relay network and SCs in general. Such a technique helps to maximize the number of users admitted in the system while minimizing the transmission power and blocking probability by jointly assigning each user to the best stations and optimally allocating the power to each station so that a low transmission power

can be assigned. To the best of our knowledge, this is the first work that proposes a new Voronoi diagram based on resource availability instead of distance.

In summary, the main novelty of the proposed work lies in the following elements:

First

Formulating the problem of resource allocation and proposing an integrated framework for multi-hop relay networks.

Second

The use of a nonlinear programming with Lagrange and KKT conditions for radio resource allocation.

Third

Deploying dynamic joint resource allocation and relay selection with nonlinear programming in multi-hop relay networks is novel. Previous works considered only a single hop relay context.

Forth

The use of a routing protocol for relay selection in multi-hop relay networks.

Fifth

The deployment of a relay-selection scheme based on an MDP in multi-hop relay networks.

Sixth

Designing a novel Voronoi-based user association scheme to maximize the number of admitted users in the system under QoS and capacity limitation constraints.

Seventh

Proposing a joint admission and power control scheme for overloaded SC networks.

CHAPITRE 1

RELAY TECHNOLOGY FOR 5G NETWORKS

Abderrahmane BenMimoune¹ and Michel Kadoch¹

¹Ecole de Technologie Superieure (ETS), University of Quebec

1100 Notre-Dame Ouest, Montreal, Quebec, Canada H3C 1K3

A Book Chapter accepted in the Springer Book Internet of Things: Novel Advances and
Envisioned Applications in December 2015

1.1 Abstract

Relaying technologies have been actively studied in mobile broadband communication systems, and were considered in the most recent standard releases of the Third Generation Partnership Project (3GPP), including “Long Term Evolution–Advanced” (LTE-A) networks. This paper provides an in-depth review of the relay technology that is being considered for future 5G networks. The article first introduces and compares different relay types that use LTE-A standards, and presents the relay benefits in terms of performance and operational costs. It then highlights future relay deployment strategies that have been discussed by the 3GPP, which supports multi-hopping, mobility, and heterogeneity. In addition, it also proposes efficient deployment strategies, along with their impact on network performance. Finally, the paper explains a few of the associated challenges that lie ahead for relay application, and provides the methodology tools and theories used in this work.

1.2 Introduction

The conventional topology of current cellular networks is a star structure, where central control points usually serve as base stations. This provides the advantage of simplicity of the architecture while still providing quality of service (QoS) guarantees. However, for next-generation networks, this topology will be disadvantageous and difficult to use due to the insufficient availability of network access. This high dependency on the central node has its

own drawbacks including inefficient offload, since all user data needs to go through the central node network. This topology also cannot offer performance and energy efficiency for users on the edge of cell coverage (“edge users”). Thus, the next-generation cellular network topology needs to be optimized, and relay will play an important role in this.

In the next-generation cellular network, cellular networks will be able to include different kinds of relays. Due to the use of relaying technologies into the centrally controlled star network, different kinds of connections—such as user equipment (UE) to UE, relay station (RS) to RS, and base station (BS) to RS—can thus be established. The hybrid topology radio network will thus naturally be the future mobile access network, which can help to overcome current and future difficulties and challenges in an efficient manner.

Relay technology is also promising in Internet of Things (IoT) applications. In IoT, relaying can have many more functions in a cellular network, such as improving the topology of the cellular network, improving the robustness of a network, and decreasing power consumption. In addition, a multi-hop topology can efficiently support tremendous access for fog computing and social networking services.

The capacity offered by a macro cell is not uniformly distributed across its coverage areas in today’s LTE network. From a user’s perspective, proximity to the cell center thus should result in much higher throughput and larger battery savings (due to reduced transmission power) than cell edge users. The 3GPP has standardized and begun supporting LTE relays in Release 10, with no impact on UE design and implementation. “Relay stations” are defined as low-power nodes that can be deployed underneath macro BSs, forming small cells to address the need for coverage and capacity improvements. One of the most attractive features of 3GPP relays is the LTE-based wireless backhaul (i.e., “self-backhauling”), as this can provide a simple deployment technique to improve coverage to dead zones (e.g., at cell edges) and, more importantly, traffic hot zones (Bhat et al., 2012). Communication between BSs and RSs is similar to the conventional communication between BSs and UEs, in which communication is accomplished via a point-to-multipoint (PMP) connection; this creates multiple paths from a BS to different RSs, and a RS can also establish PMP connectivity with

the UEs. In the following, we denote the user connected to RS by R-UE and those connected directly to Macro BS by M-UE (BenMimoune, Khasawneh, Kadoch, Sun, & Rong, 2014).

1.3 Relay classification

Relays can be classified based on several characteristics, such as operation layers, duplexing, and the resources assignment scheme, all described below.

1.3.1 Classification based on layers

In this form, relay classification is based on the layers of the protocol stack in which their main functionality is performed. There are three main types:

- a layer 1 relay, also called a “booster” or “repeater,” takes the received signal, amplifies it, and forwards it to the next hop, which may be another relay or UE. As its name implies, it works only at the physical layer. Although the advantage of this type is that they are inexpensive and simple, with minimum impact on the existing standard, they amplify noise simultaneously with the desired signals.
- a layer 2 relay, called a “decode and forward” relay, can eliminate noise signals and perform radio resource management compared to layer 1 relay; a better throughput-enhancement effect thus can be expected. However, due to the extra functions performed by a layer 2 relay, a significant processing delay is introduced, due to modulation/demodulation and encoding/decoding functions.
- a layer 3 relay, also called a “decode and forward” relay, can be thought of as a BS that uses a wireless rather than wired link for backhaul. A layer 3 relay can improve throughput by eliminating inter-cell interference and noise. However, this type of relay has an impact on standard specifications, in addition to the delay caused by modulation/demodulation and encoding/decoding processing.

1.3.2 Classification based on duplexing schemes

In general, a relay station communicates through two links: with its donor base station on one hand (through the backhaul link) and its connected users on the other (through the access link). The relay station can use either a time division duplex (TDD) or a frequency division duplex (FDD) scheme in these communications.

In a basic TDD scheme, the downlink and uplink frames of the BS–RS and RS–UE links are usually not enabled simultaneously. For example, as shown in Figure 1.1 (a), the two hop downlink transmissions occur in the first and second time slots, respectively, followed by the two hop uplink transmissions in the third and fourth time slots, respectively. We can see that only one station can transmit/receive at each time slot. Because better utilization can be achieved if more than one station can transmit/receive at each time slot, however, an extended TDD scheme can be used to improve resource efficiency as shown in Figure 1.1(b)

In the standard FDD scheme, in contrast, the downlink and uplink transmission between the backhaul link will occur in the same time slot but at different frequencies; the same will occur for the access link case, as shown in Figure 1.1 (c). However, for more efficiency, an extended scheme of the basic FDD approach can be designed to use orthogonal frequencies for each link, which will allow the backhaul and access link transmissions to occur at the same time, as shown in Figure 1.1 (d).

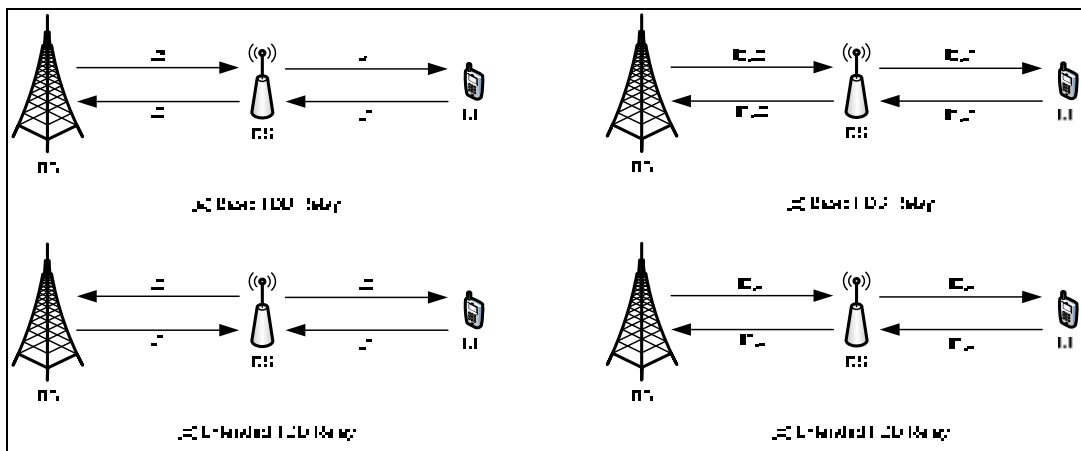


Figure 1.1 TDD and FDD schemes

1.3.3 Classification based on resources assignment

Relay nodes can be classified into inband and outband relay stations, according to the spectrum used for the backhaul link. In the inband case, the backhaul link between the BS and RS shares the same carrier frequency with the RS–UE links. The backhaul link, in contrast, uses a separate frequency band for the outband case. Figure 1.2 shows the inband and outband scenarios for a relay for integration into the cellular radio access network (RAN).

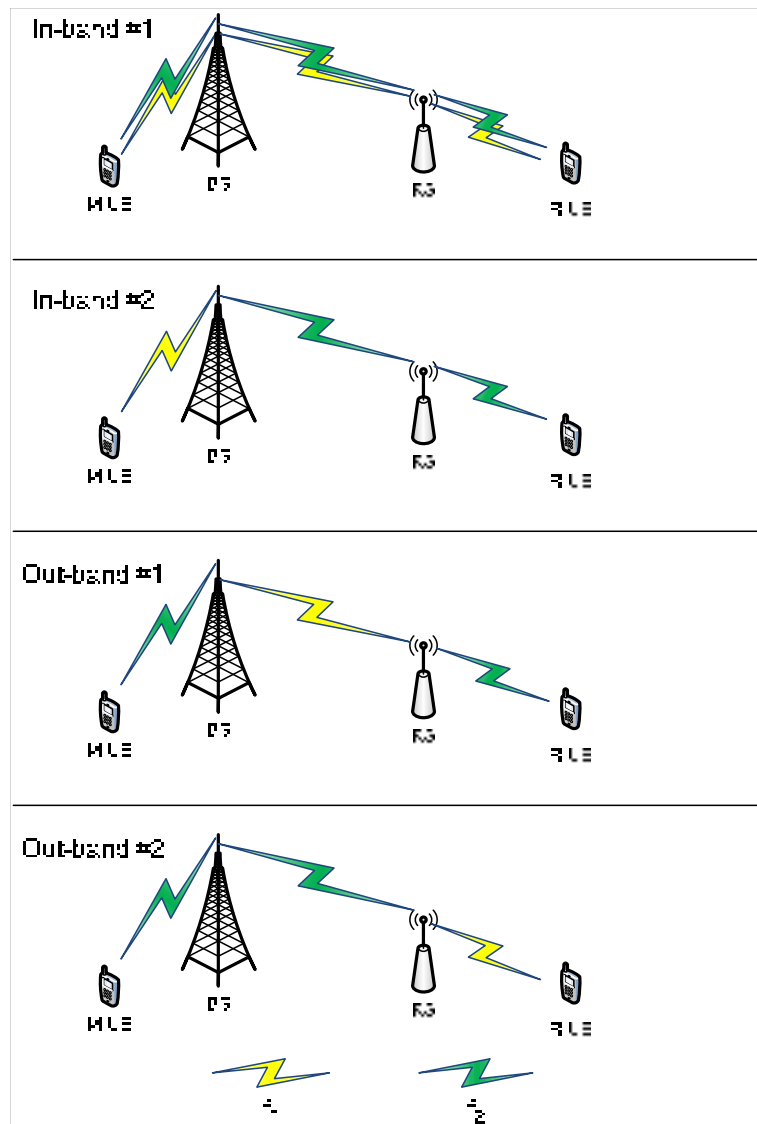


Figure 1.2 In-band and out-band scenarios

1.3.4 3GPP classification

The 3GPP's LTE-A standards have defined two types of RSs: type-I and type-II relay, also called “non-transparent” and “transparent” relay, respectively (Yang, Honglin, Jing, & Guoqiang, 2009). Relay classification is based on the relay's ability to generate its own cell control message (Kanchei et al., 2010).

- Type-I (non-transparent) relay is usually responsible for assisting UEs that are distant from the base station and out of cell coverage range. Thus, a type-I relay will generate its own cell control messages to extend the signal and service coverage, while improving the overall system capacity.
- Type-II (transparent) relay is responsible for helping UEs within the coverage area of the BS. Although the UE can communicate directly with the BS, the deployment of type-II RS can help to improve its service quality and link capacity. Since this type of relay is a part of the donor cell, cell control messages are not necessary in this case to improve the overall system.

Table 1.1 summarizes the different relay classifications discussed above, as well as their mapping.

Table 1.1 Summary of Relay Classifications

3GPP class	Layer	integration into BS	Duplex Scheme
Type 1	3	Inband	Half-duplex
Type 1a	3	Outband	Full-duplex
Type 1b	3	Inband	Full-duplex
Type 2	2	Inband	Full-duplex

1.4 Potential benefits of relaying

This section presents the potential benefits of employing relay stations in cellular networks. The following subsections describe the main motivations for the use of relay stations.

1.4.1 Relay to improve channel reliability

Cellular communication suffers from fading, path loss, and shadowing factors, which affect communication performance and tend to reduce its reliability. Relaying strategies in cellular networks can increase the reliability of the communications against these channel impairments by exploiting spatial diversity (Weihua & Ismail, 2012). When a communication channel between the BS and a user is unreliable, relays can be used as repeaters to forward the data toward the user. As a result, the user will receive several copies of the transmitted signal over different transmission paths and can combine the data received to improve transmission accuracy, as illustrated in Figure 1.3.

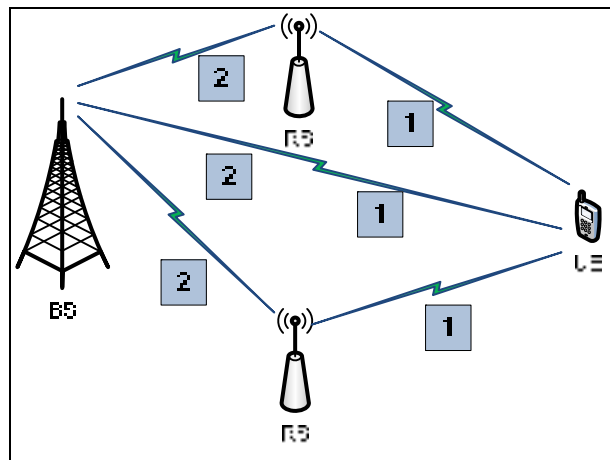


Figure 1.3 Spatial diversity for reliability improvement

1.4.2 Relay to improve system throughput

Total system throughput can be increased when using relays by aggregating the resources offered from different stations, where the data blocks are transmitted from the BS along multi-paths toward the user (Ismail & Weihua, 2012). Contrary to the previous scenario, where the same data are transmitted in different paths, when improving the system throughput, different transmission paths carry different data blocks. This has the effect of increasing the total transmission data rate between the base station and the user. As illustrated in Figure 1.4, the user is connected to several stations with sufficient resources; as

such, when these resources are aggregated, the throughput achieved by users can be increased.

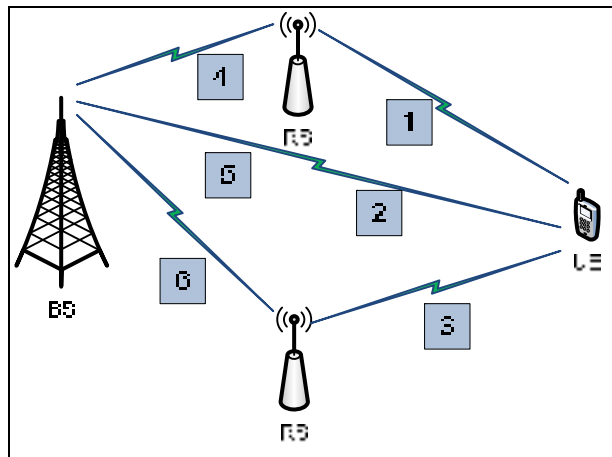


Figure 1.4 Spatial diversity for resource aggregation

1.4.3 Relay to improve service continuity

Service continuity interruption can occur for different reasons, such as coverage holes. Relay can be used as a convenient method for filling coverage holes and extending coverage. In Figure 1.5, when the service is interrupted between the base station and users, service still can be maintained using a relay path. In this case, a relay station will create a substitute path between the BS and users.

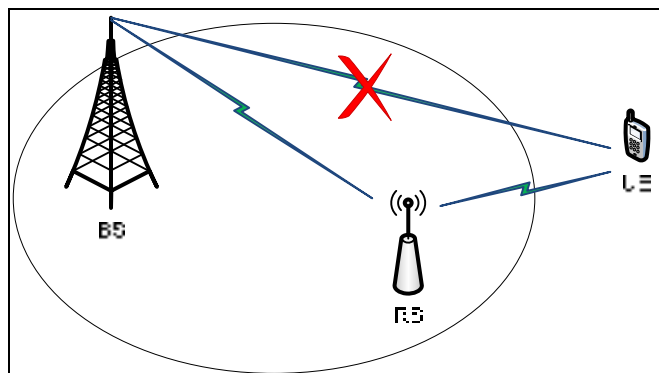


Figure 1.5 Relay for coverage extension

1.4.4 Relay for offloading and load sharing

Several techniques for cellular traffic offloading have been proposed to improve the user experience in overloaded areas. Relaying technology is one technique that can be applied to balance traffic load among highly and lightly loaded cells. As shown in Figure 1.6, preinstalled relay stations can be deployed to regulate traffic from highly to lightly loaded cells by shifting a set of users to a different donor base station. In this context, a relay station will load-balance traffic among macro cells by accepting a set of users within its coverage (Long & Hossain, 2007).

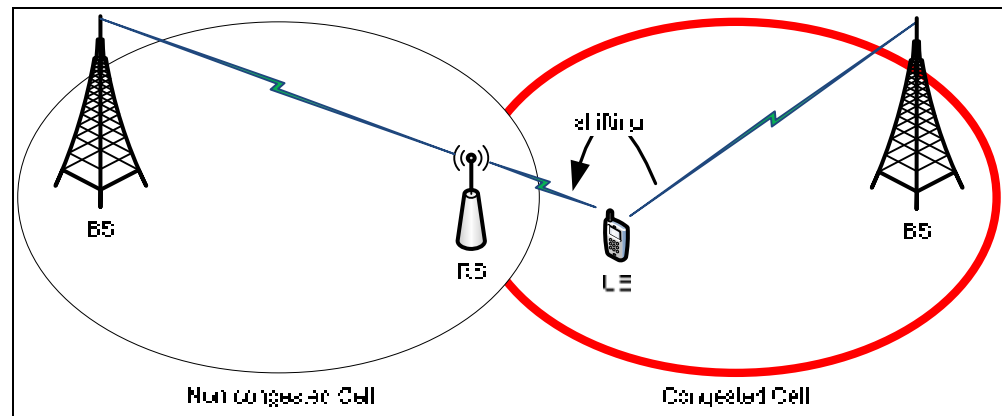


Figure 1.6 Relay for traffic load-balance

1.4.5 Relay to reduce operational costs

Relaying in cellular networks can easily reduce operation costs for service providers. For example, the transmission power can be reduced significantly by deploying relay stations in the appropriate locations. This reduction can simply be due to the reduction of the path loss, which translates into reduced operational costs. Another example is coverage extension, where relay stations can provide an easy and cheap method of extending coverage without the need to install backhaul links. Deployment costs and time thus are significantly reduced compared to traditional base stations (Akyildiz, Gutierrez-Estevez, & Reyes, 2010).

1.5 Relay deployment strategies in 5G networks

The 3GPP has discussed various scenarios in which the introduction of relay technology will be potentially useful. The basic scenario for the use of relays can be expanded by factoring in the way in which relays can help to achieve the benefits mentioned previously. Figure 1.7 shows the deployment scenarios. In scenario (a), multi-hop relay communication is an important scenario for operators to extend the coverage area to mountainous and sparsely populated regions. Scenario (b) shows the mobile relay scenario, in which relay stations are installed on vehicles (such as trains and buses) to improve throughput and reduce the volume of control signals from moving mobile stations. Scenario (c) shows a heterogeneous relay scenario, in which the relay uses the LTE network in backhaul links and the WLAN network for access links. In scenario (d), the relay station is used to relay a device-to-device (D2D) communication and offload the donor base station. Finally, in scenario (e), the relay is connected to several donor base stations to improve throughput and to balance loads across the base stations. In each of these scenarios, the type of relay that will be used may vary according to the specific requirements of each scenario.

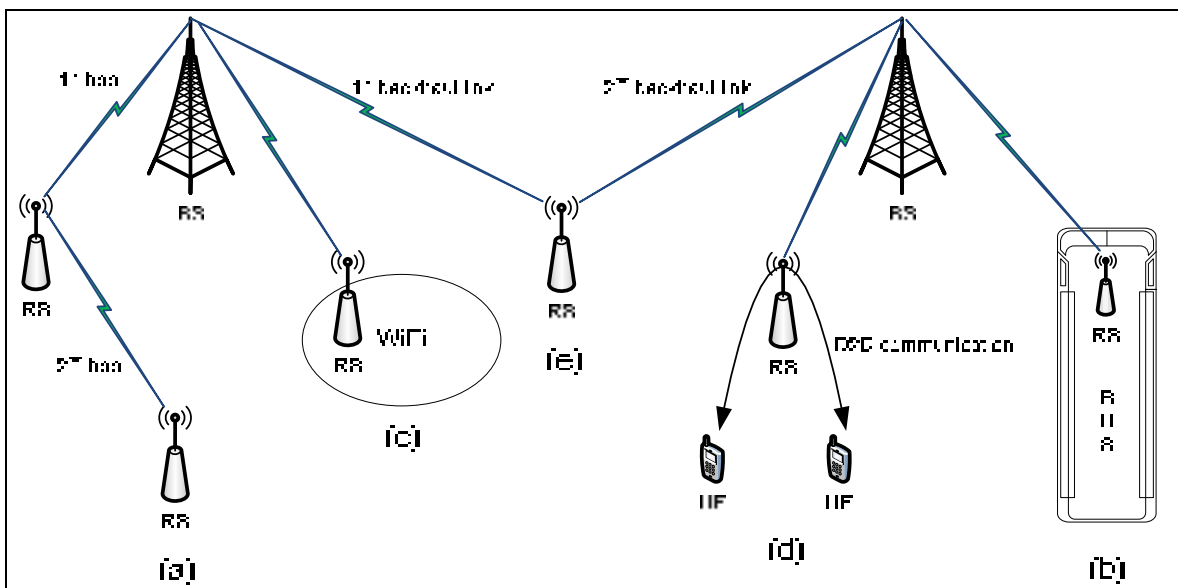


Figure 1.7 Hybrid topology with relay in 5G networks

1.5.1 Multi-hop relay

It has been more than a decade since the multi-hop cellular network architecture was first proposed and analyzed (Ying-Dar & Yu-Ching, 2000). Fundamental research projects have demonstrated the benefits of multi-hop architecture in terms of system capacity, service coverage, and network connectivity. The concept behind the multi-hop architecture could be considered to be a hybrid of mobile ad hoc networks (MANETs) and cellular networks. Today, with the recent LTE-A standards, the 3GPP supports a single-hop relay technology, in which the relay station can be fixed or mobile and the radio access link between the BS and UE is relayed by only one relay station (Docomo, 2010b). However, with the help of multi-hop relay, the radio link between the BS and UEs can be extended into more than two hops; the propagation conditions of each hop are expected to be better than the direct link used between the BS and UE in conventional cellular networks.

Improving coverage and network capacity is the leading motivation for integrating multi-hop relays into LTE-A networks. This comes from the reduction of path loss due to the employment of multiple hops to transmit data to/from the corresponding base station. In (BenMimoune. Abderrahmane & Kadoch. Michel, 2013), it was shown that better performance in terms of throughput, packet loss, and delay can be achieved by supporting multi-hop-relaying functionality. However, using a multi-hop relay system, requires more radio resources to transmit data through different hops. More interference is also created due to a larger number of simultaneous transmissions in the network. New mobility and resource allocation schemes thus are important for achieving a high QoS while increasing the whole network capacity.

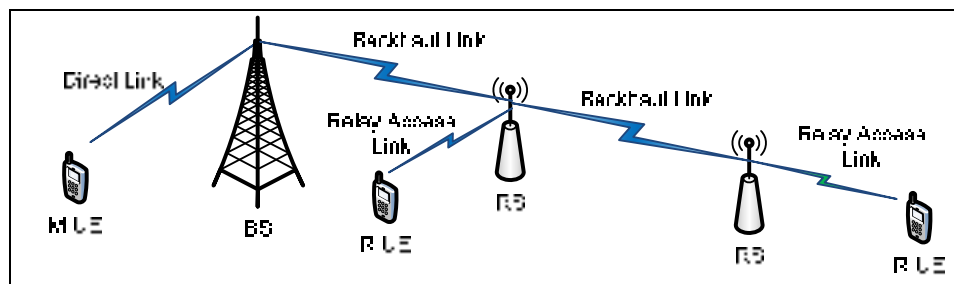


Figure 1.8 Multi-hop relay deployment

1.5.2 Mobile relay

Due to the high penetration of smart phones and tablets, the number of users who use wireless broadband services on public transportation is growing rapidly. The best solution to serve such users is to place a relay station as close as possible to the vehicle to compensate for the vehicular penetration loss. In practice, because the positions of vehicles are not known beforehand, the use of mobile relay is more economical and applicable to serve vehicular users, as shown in Figure 1.9. In a recent 3GPP study, a mobile relay deployment scenario was considered to be a cost-effective solution to serve data-intensive users using public transportation (3GPP, 2012c). In addition, the group handoff can be performed by regarding the users who are served by the same mobile relay as a group, which could reduce the probability of handoff failure. However, we can identify that the backhaul link is the capacity bottleneck of the deployment, particularly in high-speed scenarios, where more resources need to be allocated compared to fixed relay stations in a similar position.

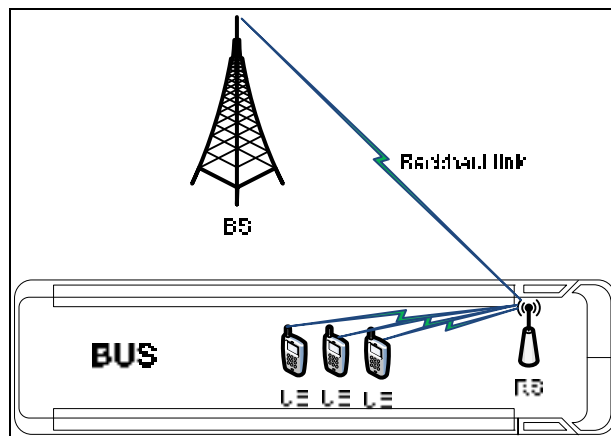


Figure 1.9 Mobile relay deployment

1.5.3 Heterogeneous relay

The WiFi access network is currently very popular, and most mobile devices and laptops are WiFi-capable. Heterogeneous relay is attractive for covering a specific local area with WiFi on the access link while using the LTE network on the backhaul link, as shown in Figure 1.10. Using heterogeneous relay combined with mobile relay to provide WiFi Internet access

to onboard data users is fairly common. The most attractive quality when using WiFi air interface for the access link is having the opportunity to serve all mobile terminals without subscribing to the operator owner of the backhaul link; this leads to the ability to optimize the number of relays, instead of having different relays for each operator. Although WiFi-only devices can also use the cellular network, which may provide extra income to service providers, using WiFi technology to provide UE with a seamless experience in the current cellular network is challenging. In addition, because WiFi networks operate on the open industrial, scientific, and medical radio (ISM) bands, any interference in these radio bands cannot be coordinated in the same manner as in the dedicated frequency bands owned by operators. It is thus difficult for operators to offer similar QoS as in their own cellular networks (Yutao et al., 2013).

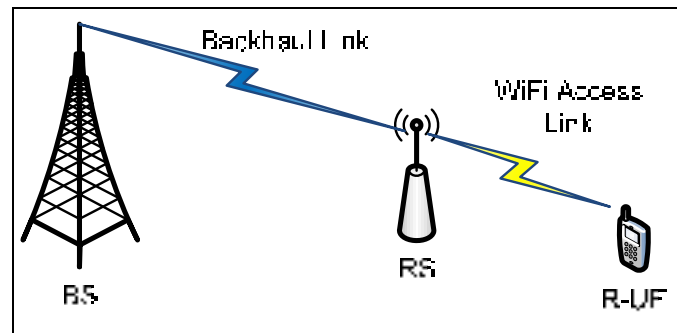


Figure 1.10 Heterogeneous relay deployment

1.5.4 Relay-assisted D2D communication

In the context of D2D communication, it is crucial to set up reliable direct links between the UEs while satisfying the QoS of traditional cellular and D2D users in the network. The excessive interference and poor propagation channel may also limit the advantages of D2D communication in practical scenarios. In such cases, with the support of relaying technology, D2D traffic can be transmitted via relay, as shown in Figure 1.11. Relay thus can efficiently enhance the performance of D2D communication, particularly when D2D pairs are too distant from each other, or the quality of the D2D channel is not good enough for direct communication (Hasan & Hossain, 2013).

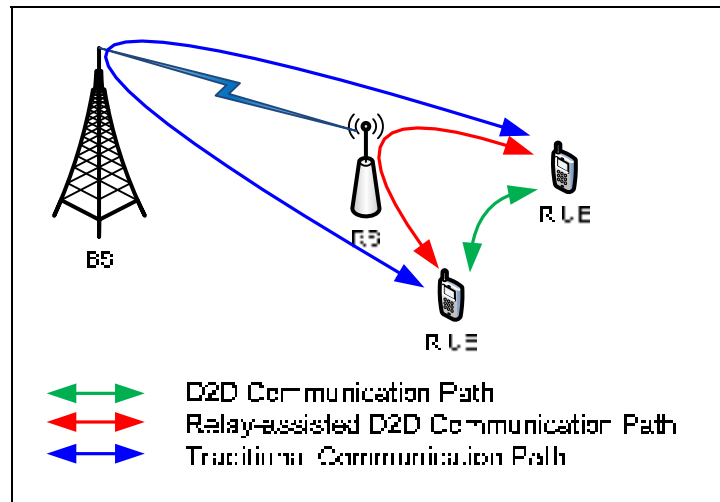


Figure 1.11 Relay-assisted D2D deployment

1.5.5 Multiple backhaul relay

When we refer to relaying, the common scenario is that there is a point-to-multipoint communication between RSs and BS, where multiple RSs can be connected to a BS, but an RS is connected to only one BS. Through such an architecture, relay deployment can be straightforward and simple; it might limit the system performance, however, because the end-to-end performance of relayed users will be constrained by the capacity available on the backhaul link, particularly when we have a lightly loaded neighboring cell (Teyeb, Van Phan, Raaf, & Redana, 2009). Multiple backhaul relay deployment can enable the many-to-many connections scheme between RSs and BSs, where the RSs can be connected to multiple BSs through the Un interface, as shown in Figure 1.12. Although this relaying scenario of deployment is completely transparent to the UEs and will make the system more flexible by creating alternatives for load sharing, changes will be required in the BS, RS, and the core network. The most significant change is the cooperation mechanism at the BS, RS, and core network, and the reordering of uplink data arriving via several S1 interfaces at the core network, and downlink data arriving via several Un interfaces at the relay station (Teyeb et al., 2009).

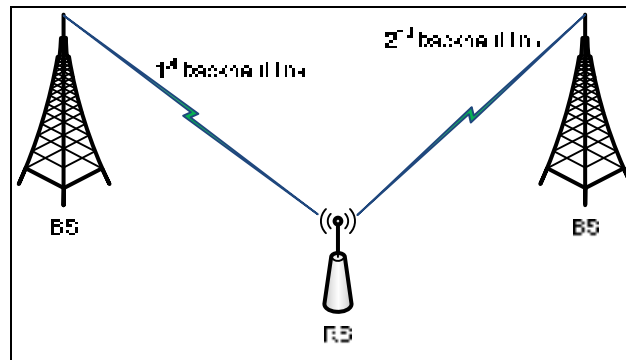


Figure 1.12 Multiple backhaul relay deployment

1.6 Challenges

While relaying within cellular networks has various potential benefits, several challenges do arise when relay stations are deployed. To support the integration of relays, a few adjustments and adaptations are required in the medium access control and network layers. In the following section, we discuss several challenges to achieving the benefits discussed earlier, and the required modifications.

1.6.1 Radio resource allocation

In the LTE network, the radio resources are composed of physical resource blocks (PRB), which have both a time and frequency dimension. Thus, different users share the PRBs that can be assigned by the BS scheduler. In addition, in the presence of an RS, the radio resources at each station (BS and RSs) are shared between the direct, backhaul, and the access links. It is thus essential to design efficient resource allocation schemes in the presence of relay stations. A dynamic resource allocation scheme may also facilitate the scheduling algorithm and interference management.

One of the most important points in radio resource allocation is to determine whether to use a centralized or a distributed strategy. Within the context of conventional cellular networks, the resource allocation scheme is considered centralized to the base station. However, within the context of relaying, a resource allocation scheme can be centralized if the central node is the

BS, and can be distributed if the resource allocation algorithm is implemented in the RSs. In centralized resource allocation schemes, the resource allocation algorithm is implemented in one central node (usually the BS); all data from relay stations is transmitted into this node to execute the allocation algorithm and to allocate resources. The problem is that the central node becomes a bottleneck of the network and needs to be very powerful. In distributed resource allocation schemes, in contrast, the allocation algorithm is implemented separately at the BS and the RSs, which results in the signaling overhead being substantially reduced. The problem in the distributed algorithms is that they are unable to achieve optimal resource allocation, as there is no central node with the ability to efficiently coordinate and control the resources that are used between different links. A suboptimal distributed resource allocation algorithm could be adopted as a solution, with minimal overhead in multi-hop relay networks.

All the radio resources in the networks with layer 1 relay are centrally managed at the BS. Layer 2 and layer 3 relays have their own resource allocation functions, so that the UEs located within the relay coverage may be managed by the RS itself. Figure 1.13 shows an example of resource allocation schemes in a multi-hop relay scenario. These examples present just an overview of the possible options, and is not an exhaustive list of FDD and TDD variations.

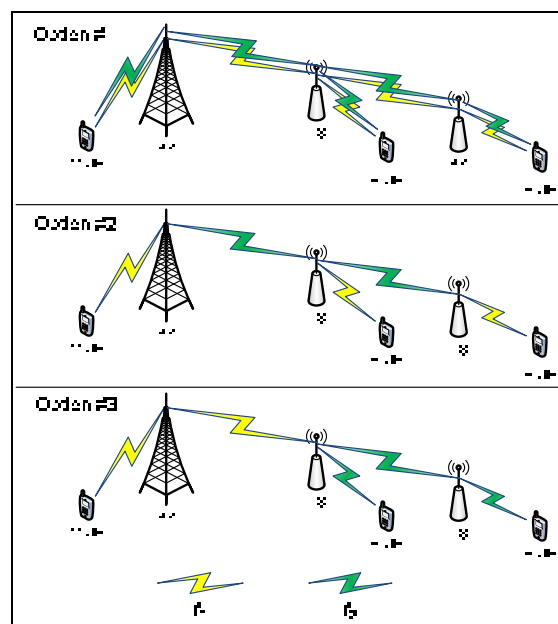


Figure 1.13 Options of resource allocation in multi-hop relay networks

1.6.2 Power control

The design of traditional cellular networks tends to maximize capacity and coverage, which can potentially lead to solutions where energy efficiency drops. In relaying networks, energy efficiency can be seen from two viewpoints. On the operator side, the energy spent by the infrastructure may increase by increasing the number of relay stations, implying high operational costs. On the user side, although the relays reduce the energy consumption by bringing the RAN closer to the end-user, some communication strategies require a high computational burden at the UE side, which has a negative impact on battery lifetime (Spectrum, 2014).

The intelligent use of energy is thus vital in achieving efficient energy usage and interference coordination, particularly in relaying networks when we consider all users (i.e., users connected directly and users connected through relays) to be equals and when their QoS requirements are delivered with the same priority. In addition, in conventional cellular networks, it was always assumed that the base station had “free” (meaning unlimited) access to energy; this is not necessarily true for relaying scenarios, particularly in mobile relay where the relay can have a limited power source. The power allocation scheme can also be centralized in the BS or distributed among the relays, which makes it more complex to employ. The power control mechanism can be considered jointly with the admission control mechanism and a resource allocation strategy to optimize the network performance. Power efficiency for relaying in cellular networks thus remains a challenge that needs to be solved.

1.6.3 Admission control

In a conventional cellular network, the base station manages the admission control policy. In other words, if a user wishes to establish a new call and the radio resources are not available in its home BS, he or she will be automatically blocked. In the relaying context, the admission control should be coordinated between the BS and its subordinate relays, thus generating a lot of delay as well as signaling overhead particularly for R-UEs, while the resource availability of the access links cannot be the only metric for decision making. The resource availability on

the backhaul links also should be considered in order to guarantee the availability of resources through the wireless radio path. These relaying schemes thus need to be well designed and operating as intended in order to reduce call blocking probability and to improve QoS fairness in terms of call blocking probability by balancing traffic among congested and non-congested cells.

1.6.4 Relay selection

The relay selection process specifies the user assignment scheme to the different stations that are available in the network. Usually in conventional cellular networks, the UE selects one of the base stations available based on the channel condition, such that the user will achieve a high level of throughput. However, in the relaying context, the relay selection problem can be more complex, since users may have several relay stations in their range that they can choose from: particularly since the user-achieved throughput is mainly affected by the decision to associate a user with one station. In addition, the conventional rule in a user association scheme is usually that a user can only be connected to one station at a time. In a dense relay deployment, however, a multiple relay selection can also be employed to enhance the user data rate.

The selection scheme can be executed in either a centralized or distributed manner. In a centralized scheme, each RS will collect channel and location information from users in its vicinity and will forward the information to the donor BS, which will serve as a central point for making appropriate pairing decisions. In a distributed selection scheme, in contrast, each RS selects an appropriate UE in its neighborhood based on local channel information. Generally speaking, centralized schemes require more signaling overhead, but can achieve better performance gains than their distributed counterparts.

1.6.5 Handoff

The handoff mechanism plays a critical role in the mobility management protocol design. In conventional cellular networks, the user only has the option to execute a handoff between BSs. In the relaying context, on the other hand, the handoff algorithm might be more complex, and could require the use of more coordination and cooperation mechanisms to provide a guaranteed QoS. The introduction of relay stations enables several handoff scenarios, which can be categorized into intra-BS and inter-BS handoff. The main difference in these scenarios is which nodes are the old access station and which are the new access station. If both the new and old access stations are in the same BS cell, then it is an intra-BS handoff procedure; otherwise, it is an inter-BS handoff, as shown in Figure 1.14.

The increasing density of relays in cellular networks may also increase the handoff rate, since more cell boundaries will be present in the network, which provides more opportunities for the UE to be handed over. As such, the classical handoff metrics (such as location and signal strength) may not be enough in decision-making; we should also take into consideration other relaying metrics, such as the load of the backhaul links and the target relay cell. For the mobile relay context, the handoff mechanism is applied to the UEs, as well as to the mobile RS itself. The handoff design issue is therefore common for users and mobile RS. The mobile RS handoff also needs to consider group mobility issues, as well as the subsequent configuration of the whole mobile group (H. Y. Wei, Rykowski, & Dixit, 2013).

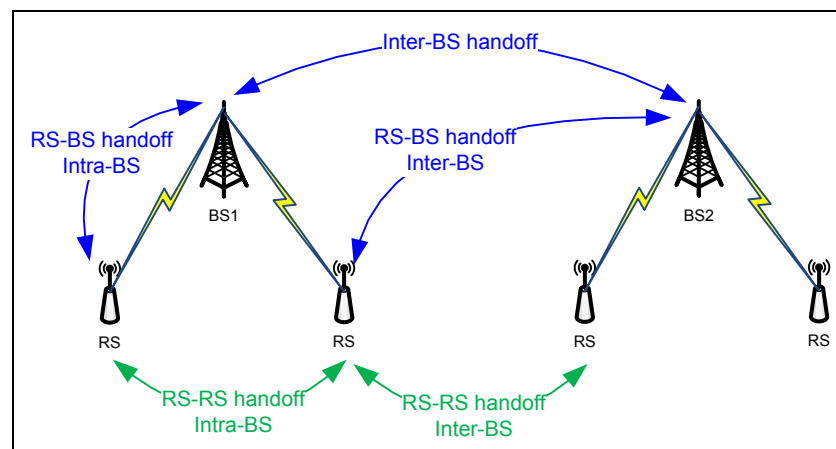


Figure 1.14 Handoff scenarios in relaying networks

1.6.6 Routing

The traditional cellular network is based on a star topology, where all UEs are connected directly (single-hop) to the BS. The routing functionality therefore has no significance in this scenario. In the relaying context, however—and particularly in multi-hop relay networks with multiple backhaul capabilities—the purpose of a routing protocol is to find the appropriate radio path for each user to establish a connection to its home BS. In cellular networks, each user’s access is typically based on the criterion of maximizing received signal strength. This routing criterion has not taken into account the characteristics of relay transmission, particularly the backhaul link. Since two-hop transmission may lead to increased delay, bandwidth utilization, and packet loss, it is more reasonable to use the QoS metrics as the routing criteria. A fundamental question that still needs to be solved in multi-hop relay networks is therefore how to perform joint relay selection and routing, such that maximum performance gains in terms of network capacity, coverage, and QoS performance can be achieved.

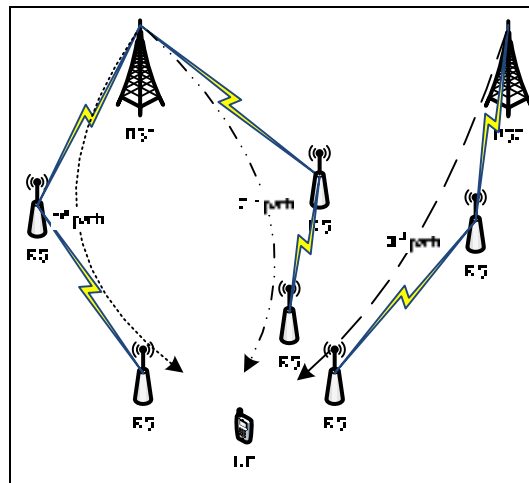


Figure 1.15 Example of routing in multi-hop relay networks

1.7 Methodology Tools

This section consists of brief high-level definitions of the proposed tools and theories to be used in this work to achieve the aforementioned objectives.

1.7.1 Nonlinear Programming Theory

Nonlinear programming can be defined as a mathematical method that can be employed by means of achieving optimal outcomes. Usually, the purpose of nonlinear programming is to find the minimum or maximum possible value for a problem defined by a mathematical model, where some of the constraints or the objective function are nonlinear (Bertsekas, 1999). During the past decade, nonlinear programming has gained a lot of attention in various fields, including transportation, energy, manufacturing, and computer science. Obviously, many important applications require we be able to handle nonlinear objective functions and constraints (Jünger et al., 2009). The structure of a general optimization problem is usually defined by the following elements:

Objective function: This is the key element of the optimization problem that represents the objective to be optimized (either maximized or minimized).

Constraints: These elements define the boundaries of the objective function associated with the optimization problem.

Decision variables: These are the variables to be optimized by the model in order to reach the optimal value of the objective function.

Variable bounds: These represent the minimum and maximum limits of the decision variables.

Traditionally, optimization problems can be divided into two categories, depending on whether the variables used in the objective function are continuous or discrete. In both cases, the nonlinear problems are usually solved using a numerical algorithm, particularly for large-scale problems. However, solving such problems may impose high computational overhead. Therefore, an analytic method such as the method of Lagrange multipliers and its extension, KKT conditions, are considered excellent techniques to solve nonlinear problems (Bertsekas, 1999). In the context of our work, the concept of nonlinear programming is used in Chapter 2 to address the resource allocation problem in multi-hop relay networks.

1.7.2 Markov Decision Theory

The theory of MDP studies sequential optimization of discrete time stochastic systems to provide efficient decision-making frameworks based on mathematical modeling (Puterman, 1994). Usually, the decisions in real life have two types of impacts: (a) an impact on the cost (revenues), time, or other resources and (b) an impact on the future by influencing the dynamics. Therefore, in many situations, decisions with the largest immediate profit may not be good in view of future events. MDPs model this paradigm and provide results in terms of the structure and existence of good policies and methods for their calculation (Feinberg & Shwartz, 2001).

Depending on instances of the system review, MDPs can be classified in either discrete or continuous time-spaces. The basic model is a discrete-time stochastic system whose transition mechanism can be controlled over time. Each control policy defines the stochastic process and values of objective functions associated with the process (Vyalyi, Gordeyev, & Tarasov, 1996). The following figure is an example of a MDP for a light switch system.

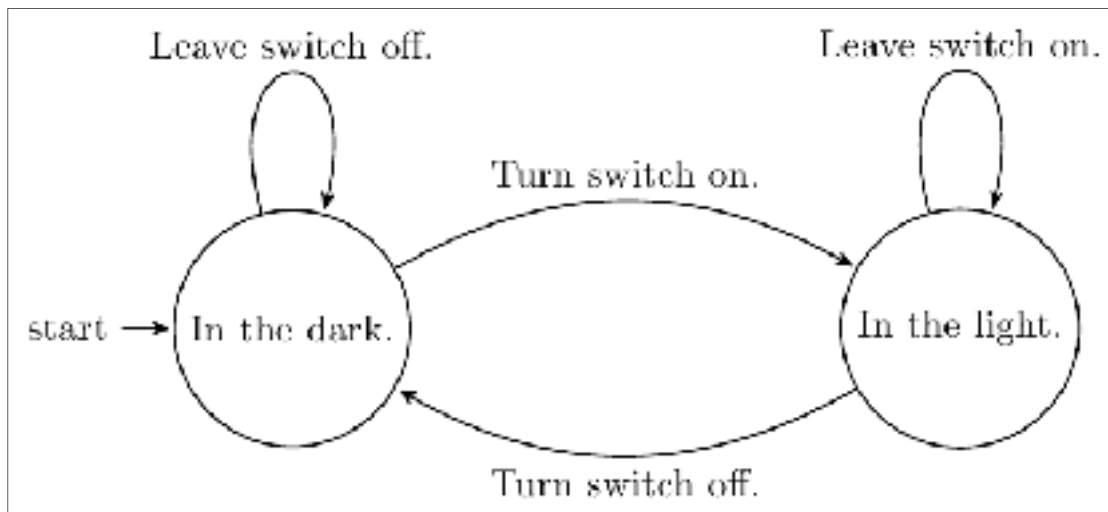


Figure 1.16 Example of a MDP state-transition diagram for a light switch system

Generally, an MDP is represented by a 5-tuple structure (S, A, P, R, D) where:

- States (S): the set of possible states in the system where the state can be considered as a random value that describes the system at a given time instant. In the example given above, we have two states: the light is “on” or the light is “off”.
- Actions (A): the set of possible actions in the system where an action describes the dynamic changes in the system state at a given time instant. In the example above, the actions are: “Turn on light”, “Leave switch on”, “Turn light off” and “Leave switch off”.
- Probabilities (P): the transition probabilities from all states in the system. In the example above, the probability to turn off a switch is the probability to transit from the state of the light being on to the state of the light being off.
- Reward (R): the immediate reward received after the transition to a particular state in the system. In relation to the example above, when the light is on, drivers on rural roads drive more safely, for example.
- Discount (D): is the discount factor that represents the difference between future and present rewards. In relation to the example above, the discount factor can be seen as safety rewards versus energy consumption rewards.

MDP theory is a multi-disciplinary one that has attracted much attention from researchers in many disciplines, including economics, robotics, computer science, etc. In the context of our work, the concept of an MDP is used in Chapter 3 for relay selection decision making in multi-hop relay networks.

1.7.3 Voronoi Diagram

Voronoi diagram, also known as Voronoi tessellation, is one of the basic structures in computational geometry that can be employed to decompose a Euclidean plane into regions based on distance to specific points in the plane (Vyalyi et al., 1996). These sets of points are called sites and the regions are called Voronoi cells. For each site, there is a corresponding cell consisting of all points closer to that site than to any other. As seen in Figure 1.17, a Euclidean plane with several sites specified beforehand, the plane is divided into cells so that

each cell contains exactly one site. For every point in the cell, the Euclidean distance from the point to the site within the cell must be smaller than the distance from that point to any other site in the plane. If this rule is followed across the entire plane, then the boundaries of the cells, known as Voronoi edges, will represent points equidistant from the nearest two sites. The point where multiple boundaries meet, called a Voronoi vertex, is equidistant from its three nearest sites.

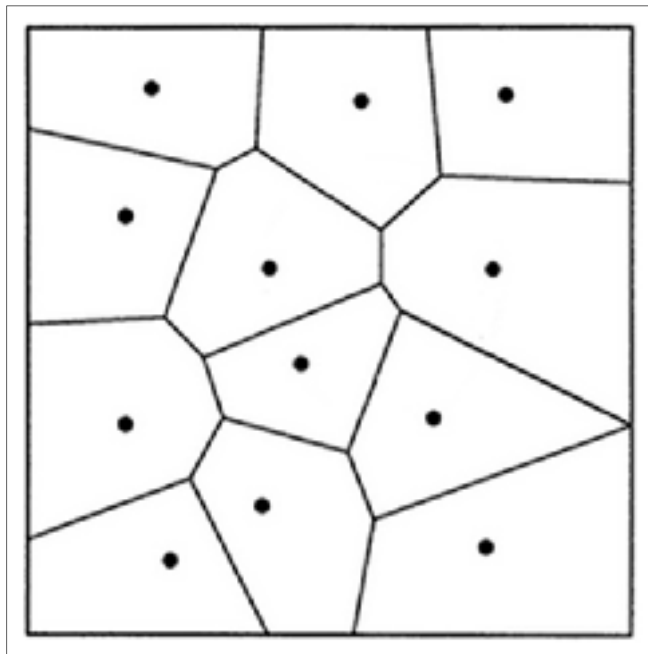


Figure 1.17 Example of Voronoi diagram

Voronoi diagram has many possible applications within the field of engineering (Aurenhammer, 1991). The various sub-disciplines of engineering all have problems that can benefit from such an approach such as materials, structural, transport, computer engineering. In the context of our work, a customized Voronoi diagram is used in Chapter 4 to address the user association problem in HetNets.

1.8 Conclusion

In order to better support IoT applications, five key deployment features in LTE-A systems were discussed in this article. Each brings certain advantages to wireless mobile networks, for both operators and users. Multi-hop relay can provide great advantages by extending coverage to mountainous and sparsely populated areas, which other kinds of base stations cannot do. Heterogeneous relay can improve coverage while saving bandwidth on the access link. Mobile relay enhances the data rate of high-speed mobile users. Multiple backhauling can provide higher peak data rates and improvements for cell edge users' experience. Relay-assisted D2D offloads the serving base station as well as enhancing the average data rate. These deployment features are likely to be enhanced further and considered in 5G networks and future wireless mobile technologies. The paper also presented a few challenges in lower layers to achieving the benefits and discussed the required modifications. In addition, the methodology tools expected to be used in Chapter 2, 3 and 4 have been presented.

CHAPITRE 2

DYNAMIC JOINT RESOURCE ALLOCATION AND RELAY SELECTION FOR 5G MULTI-HOP RELAY SYSTEMS

Abderrahmane BenMimoune¹, Fawaz A. Khasawneh¹, Bo Rong² and Michel Kadoch¹

¹Ecole de Technologie Superieure (ETS), University of Quebec
1100 Notre-Dame Ouest, Montreal, Quebec, Canada H3C 1K3

²Communications Research Centre Canada (CRC)
3701 Carling Ave, Ottawa, Ontario K2H 8S2

An Article accepted in the Springer Telecommunication Systems

Journal in December 2015

2.1 Abstract

Cellular relaying architecture is in an early stage for development and deployment. A restricted number of deployment scenarios are addressed in the LTE-A relay standard, though different design options in alternative deployment scenarios do potentially exist. Presently, the LTE-A relay standard is restricted to two-hop relaying. The principal reason for opting for this architecture is to minimize system complexity. Nonetheless, multi-hop relay architecture could potentially provide greater capacity and coverage, in the future, particularly for urban sparse area deployment scenarios. However, many problems involving the complexity of multi-hop relaying paradigm need to be resolved, specifically resource management. In this work, we focus on the resource allocation and relay selection problem, in which a user may be connected to BS through a multi-hop relay station and have several relay stations from which to choose in his range. To overcome the additional challenges introduced by the multi-hop relay nodes, we propose a dynamic joint resource allocation and relay selection scheme. Numerical results are presented to demonstrate the validity of the proposed algorithm.

2.2 Introduction

The conventional topology of current cellular networks is a star-shaped structure with central control points. This structure makes it simple to provide quality of service (QoS) guarantees. In next generation networks, this topology will not help to increase efficiency in bandwidth utilization, especially when all user data need to go through the core network. Thus, the cellular topology needs to be hybrid with different kinds of connections using new technologies such as relay nodes, small cells and device-to-device communications, which can play important roles in overcoming the difficulties and challenges of next generation networks (Shanzhi & Jian, 2014). Relaying is considered to be one of the key functionalities for 3GPP releases 10 and 11 of Long Term Evolution-Advanced (LTE-A) in order to improve the cell-edge user throughput, and to extend coverage to new areas by flexible and easy deployment (Parkvall et al., 2011). With relaying, the User Equipment (UE) connects to the network via a relay station (RS) that is wirelessly connected to a base station using the LTE radio interface technology (Parkvall et al., 2011). The base station (BS) or evolved NodeB (eNB) may serve one or several relays in addition to directly serving the macro UEs (M-UEs) (3GPP, 2012a).

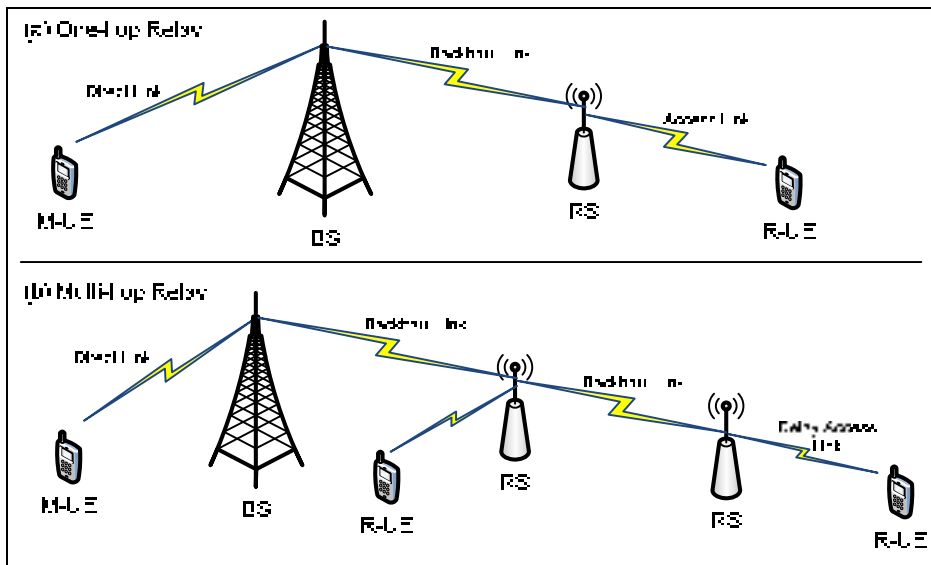


Figure 2.1 LTE Relay Architecture: (a) single-hop relay (b) multi-hop relay

In the current 3GPP relaying standard (3GPP, 2012c), LTE-A is limited to a single-hop relay scenario: a backhaul link from the BS to the RS, and an access link from the RS to the relay UE (R-UE) (Figure 2.1-a). Consequently, an RS is unable to use a different RS as its donor station. An RS has to directly connect to the BS, but without passing through several hops. The principal reason for choosing this architecture is to reduce system complexity and to minimize the impact on the existing LTE-A standard. However, multi-hop relaying (Figure 2.1-b) has been identified as a valuable wireless paradigm in the future releases of LTE, particularly for urban sparse area deployment scenarios in which it is able to improve coverage and network capacity due to the reduction of path loss by replacing the direct low quality link between the BS and UEs with multiple high-quality links through one or multiple RSs.

In (Long & Hossain, 2007; Saleh, Redana, Hämäläinen, & Raaf, 2010; Schoenen, Halfmann, & Walke, 2008; Schoenen, Zirwas, & Walke, 2008), it has been shown that a better performance in terms of coverage and network capacity can be achieved by supporting multi-hop relay architecture. However, using a multi-hop relay functionality requires more resources to transmit data through different hops, which leads to longer delays and significant impact on quality of service (QoS). Therefore, new, more efficient resource management schemes are crucial to achieving high QoS while increasing the whole network's capacity. The resources of interest in this context are bandwidth, buffer size, power, etc., which may or may not be allocated independently. In this work, we are principally concerned with the allocation of bandwidth as a resource. All other types of resources will be considered outside the scope of this work. Therefore, we use the terms “resource” and “bandwidth” interchangeably unless specified otherwise.

The resource allocation plays a critical role since it manages channel access in both time and frequency domains, and determines how resources are allocated for different links. In the presence of an RS, the radio resources at each station (BS and RSs) are shared between the direct, backhaul, and the access links. This occurs during both in-band and out-band modes of relay operation. A critical task here is to choose how the resources should be shared between direct, backhaul and access link.

The remainder of this paper is set out as follows: Section 2 discusses the literature on multi-hop relay networks and some related works. Section 3 describes the system model considered in this paper, and Section 4 presents the problem formulation. Our proposed algorithm scheme is presented in Section 5, and our simulation and results are described in Section 6. Finally, we form a conclusion in Section 7.

2.2.1 Related Works

The potential gain in coverage and capacity in multi-hop relay networks is highly dependent on the resource management scheme (Salem, Adinoyi, Rahman, et al., 2010; Salem, Adinoyi, Yanikomeroglu, & Falconer, 2010), a topic which draws more attention from the scientific society. Performing resource management in such a complex environment is a big challenge since an increased number of links makes the resource allocation problem difficult to tackle. Previous studies focused on solving this problem in different scenarios, such as downlink or uplink single-cell or multi-cell network by using different constraints such as fairness, load balancing, and traffic awareness for the relay networks. However, the majority of the existing literature studies the single-hop case as it is simpler than studying the multi-hop. A network scenario with a single relay station is studied in (Kaneko & Popovski, 2007), while such a network with multiple relay stations is studied in (Wooseok, Woohyuk, Sae-Young, & Lee, 2007). In (Oyman, 2010), the proposed idea is to group users based on their location to allocate the resources in the downlink of a relay-enhanced network. In this selection strategy, the near users are restricted to connecting to the base station over a direct connection, and users farther away can connect to the base station in only two hops through the closest relay station.

A semi-distributed downlink OFDMA single-cell scenario, enhanced with fixed relays, is considered in (Mi Kyoung & Lee, 2007). This scheme is the most common: the users are divided into disjointed sets located in the neighborhood of the base station and the relays. The base station allocates some resources to its M-UEs, and to the R-UEs through the relay station, assuming that there is an available algorithm to collect the CSI (Channel State Information) and that the routing is already done. A fairness-aware resource management

algorithm is proposed in (Salem et al., 2009), and two other algorithms are presented in (Kaneko & Popovski, 2007) to improve the overall throughput and coverage while minimizing the complexity and the required amount of CSI.

A resource allocation algorithm based on the number of relay-attached users and direct users was proposed in (Liebl, de Moraes, Soysal, & Seidel, 2011). In (3GPP, 2010), BS assigns resources for relay stations based on the number of users, in such a way resource allocated to each user become equal. However, the number of relay-attached users (R-UEs) may not always reflect the traffic demand of the relay, so partitioning resources solely based on number of users is incorrect.

The resource allocation problem in (Roth, Jiansong, & Danev, 2010) is stated as a problem with system performance optimization, and the optimal throughput is achieved with the backhaul link defining the relay system's restriction. The problem is that the allocation considers that the BS is conscious of the backlog and the access links spectral efficiency. In (Cheol & Hyung-Myung, 2008), a scheme for resource allocation in multi-hop relay networks is suggested, thus solving the joint sub-channel allocation, power allocation and flow routing problems in OFDMA multi-hop cellular cooperative networks. A concave and differentiable utility function is suggested as a means of dealing with heterogeneous applications. A subcarrier and power allocation scheme which guarantees load fairness among relays is presented in (ChiSung & Dong-Ho, 2007). In (Kwak & Cioffi, 2007) and (Lei, Mengtian, Lan, Yisheng, & Schulz, 2007), resource allocation algorithms are proposed to maximize the sum rate in an OFDMA multi-hop relaying downlink single-cell situation. In (Girici, Chenxi, Agre, & Ephremides, 2008), a joint power and resource allocation scheme for downlink transmission in the presence of half-duplex RSs is put forward. The algorithm can distinguish between different types of traffic and offers proportional fairness for data users, yet still manages to satisfy delay requirements for real-time traffic.

Most of the existing work on multi-hop relay communications is not suitable for practical applications due to the complexity of the problem, particularly when the network concerned is large. Therefore, a new resource allocation and relay selection scheme will be necessary to reduce the time-complexity whilst producing near-optimal solutions.

2.2.2 Our Contribution

In this paper, we develop and evaluate a joint resource allocation and relay selection scheme for multi-hop relay networks. First, we formulate the problem of resource allocation and propose an integrated framework for multi-hop relay networks; second, a fast approximation analytical solution for resource allocation algorithm is proposed, which takes into account the trade-off between the optimality and the complexity of the multi-hop relay architecture; finally, a heuristic relay selection strategy is presented which considers the relay station load and helps to keep the relay from being overloaded.

2.3 System Model

Our system model is derived from similar models used in past works (BenMimoune et al., 2014), with suitable modifications to capture the resource availability in multi-hop relay networks. In this work we consider the downlink transmission of a single-cell base station with up to two-hop relay architecture as depicted in Figure 2.2. The geographical region is entirely covered by a macro cell, overlaid with several RSs forming a multi-hop network. The relay station cannot have more than one parent but can have several child relays. Each station (either the BS or an RS) serves a set of users who are uniformly distributed in the geographical area. A minimum distance between two neighboring relays is taken into account to effectively distribute the relays in targeted areas based on relay transmission power and the area covered. Different propagation channel models are used for the BS's and RS's transmissions.

We assume in our model that we will work in an infinitely backlogged model in which all stations offer Continuous Bit Rate (CBR) applications to their attached users in order to fully utilize the allocated bandwidth.

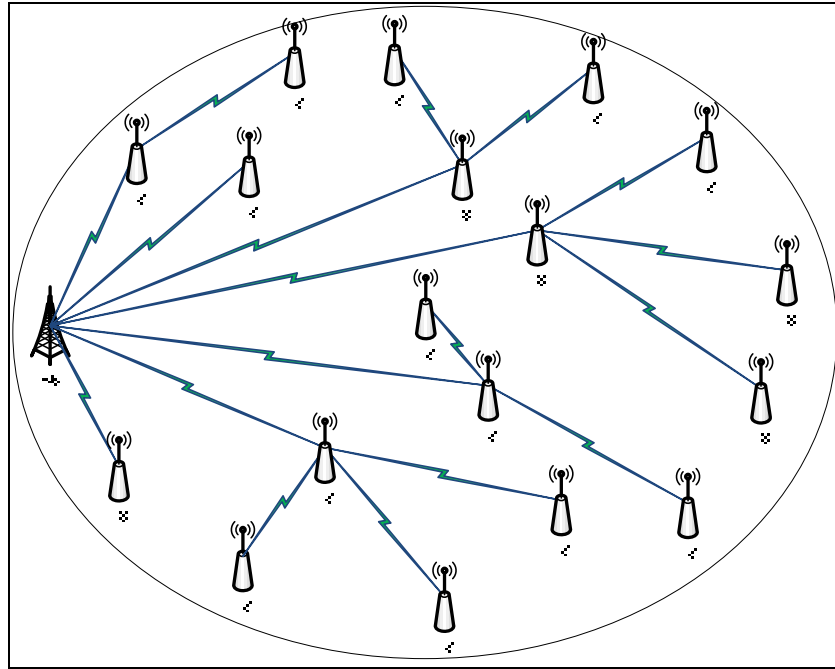


Figure 2.2 Network system model

We focus on the downlink resource allocation in this paper. The total bandwidth of the system is assumed to be divided into orthogonal sub-channels. Our proposed resource allocation algorithm is performed through the sub-channel allocation with the assumption of fixed transmission power allocation to each sub-channel. Each station (BS and RS) is given an allocated number from all available channels in the entire system. To minimize interference, neighboring stations are assigned different channel groups.

UEs are assumed to move randomly with intra-RSs handoff capabilities. Also, it is assumed that a system is deemed to be static when there are no arrivals of new calls and departures of existing calls.

2.4 Problem Formulation

This section presents the formulation of the resource allocation and the relay selection problem in LTE multi-hop relay networks, and a framework of the joint solution for such a problem is presented.

2.4.1 Resource Allocation and Relay Selection Framework

Let u_{ij} denote the utility function of user j for an allocated resource $\gamma_{i,j}$ from station i . This utility function renders the amount of benefit that the user obtains for different amounts of allocated resource. The utility function for a user j who is connected to station i can be expressed in the following form:

$$u_{ij} = \ln(1 + r_{i,j}^A) \quad (2.1)$$

where $r_{i,j}^A$ is the achievable throughput at user j from station i . The utility function is concave, corresponding to the common Proportional Fairness objective (Andrews, Lijun, & Stolyar, 2005), and is suitable for modeling VBR (Variable Bit Rate) services such as file downloading applications. The objective of station i is to maximize its total satisfaction for the users within its coverage area, given by

$$U_i = \sum_{j \in n_i} x_{i,j} \ln(1 + r_{i,j}^A) \quad (2.2)$$

where U_i is the total utility of station i , rendered by the summation of the users' utility function within the coverage area. n_i is the set of users connected to station i . We associate the set of variables $\{x_{i,j} | (i = 1, 2, \dots, N_s, j = 1, 2, \dots, M)\}$ to the assignment problem, where $x_{i,j} = 1$ if user j is connected to station i and $x_{i,j} = 0$ otherwise.

$$\sum_i x_{i,j} = 1, \quad x_{i,j} \in (0, 1), \quad \forall j \quad (2.3)$$

The network throughput is calculated by multiplying the bandwidth assigned by the spectral efficiency in the macro or relay cells.

$$r_{i,j}^A = \gamma_{i,j} A_{i,j} \quad (2.4)$$

$$r_{i,k}^B = \delta_{i,k} B_{i,k} \quad (2.5)$$

where $r_{i,j}^A$, $\gamma_{i,j}$ and $A_{i,j}$ are the throughput, bandwidth and spectral efficiency on the access link respectively between station i and user j ; $r_{i,k}^B$, $\delta_{i,k}$ and $B_{i,k}$ are the throughput,

bandwidth and spectral efficiency on the backhaul link respectively between the parent station i and child RS $_k$.

Table 2.1 Summary of important symbols

Symbol	Definition
$x_{i,j}$	User association parameter between station i and user j
$\gamma_{i,j}$	Allocated bandwidth from station i to user j
$\delta_{i,k}$	Allocated bandwidth from station i to child relay station k
$r_{i,j}^A$	Achieved throughput at user j from station i
$r_{i,k}^B$	Achieved throughput at station k from station i
$A_{i,j}$	Spectral efficiency on access link between station i and user j
$B_{i,k}$	Spectral efficiency on backhaul link between station i and k
$\langle A_{i,j} \rangle$	Mean of the spectral efficiency of users connected to station i
C_i	Transmission capacity of a station i
m_i	Set of child relay stations backhauled to the station i
n_i	Set of users served by the station i
N_s	Total number of base and relay station in the region
M	Total number of users in the area
$L(\cdot)$	Lagrangian function
λ_i	Lagrange multiplier corresponding to capacity constraint

We are looking to maximize the total utility function U , which depends on the allocated resources $\gamma_{i,j}$

$$U(\gamma) = \sum_{i=1}^{N_s} \sum_{j=1}^M x_{i,j} \ln(1 + r_{i,j}^A) \quad (2.6)$$

where the total load of each station i in the geographical region cannot exceed the capacity limitation C_i :

$$\sum_{j \in n_i} \gamma_{i,j} + \sum_{k \in m_i} \delta_{i,k} \leq C_i, \quad \forall i \quad (2.7)$$

For each relay station i , the throughput of a backhaul link should be equal to the total throughput of child relay stations and served users.

$$\sum_{j \in n_i} r_{i,j}^A + \sum_{k \in m_i} r_{i,k}^B = r_{i,i}^B, \quad \forall i \quad (2.8)$$

To summarize, the joint resource allocation and relay selection problem in multi-hop relay environments can be expressed by the following optimization problem:

$$\begin{aligned}
& \max_{\gamma > 0} U(\gamma) \\
\text{s. t. } & \sum_{j \in n_i} \gamma_{i,j} + \sum_{k \in m_i} \delta_{i,k} \leq C_i, \quad \forall i \\
& \sum_{j \in n_i} r_{i,j}^A + \sum_{k \in m_i} r_{i,k}^B = r_{i,i}^B, \quad \forall i
\end{aligned} \tag{2.9}$$

The inequality in (2.7) has a simple meaning: the resources provided by station i cannot exceed its capacity C_i . Then, without a loss of generality, we can replace the inequality (2.7) by the equality (2.10)

$$\sum_{j \in n_i} \gamma_{i,j} + \sum_{k \in m_i} \delta_{i,k} = C_i^*, \quad \forall i \tag{2.10}$$

where $C_i^* \leq C_i$ is the actual bandwidth currently used by station i .

In the following, we first present a solution to the problem of resource allocation in a single-hop relay, and then show how it can be extrapolated to the case of multi-hop relays. First, let us consider a relay station i (a station that has no child RS connected to it) and assume that n_i is the number of users connected to it, and the total bandwidth C_i^* provided to those users is known. Then, let us construct the Lagrangian function:

$$\begin{aligned}
& \max_{\gamma > 0} \sum_i \sum_j \ln(1 + \gamma_{i,j} A_{i,j}) \\
\text{s. t. } & \sum_{j \in n_i} \gamma_{i,j} - C_i^* = 0, \quad \forall i
\end{aligned} \tag{2.11}$$

The Lagrangian function for (2.11) can be expressed as

$$\mathcal{L}_i(\gamma, \lambda) = \sum_j \ln(1 + \gamma_{i,j} A_{i,j}) + \lambda_i \left(\sum_j \gamma_{i,j} - C_i^* \right) \tag{2.12}$$

Each relay station can now find its optimum allocation $\gamma_{i,j}$ for a fixed value of λ_i by applying the Karush-Kuhn-Tucker (KKT) conditions on (2.12) (Bertsekas, 1999), and we have

$$\frac{\partial \mathcal{L}_i}{\partial \gamma_{i,j}} = \frac{A_{i,j}}{1 + \gamma_{i,j} A_{i,j}} + \lambda_i = 0 \quad (2.13)$$

$$\gamma_{i,j} = -\frac{1}{A_{i,j}} - \frac{1}{\lambda_i} \quad (2.14)$$

The constant λ_i can be found from the constraint of problem (2.11):

$$\sum_j \gamma_{i,j} - C_i^* = -\sum_j \left(\frac{1}{A_{i,j}} + \frac{1}{\lambda_i} \right) - C_i^* = 0 \quad (2.15)$$

Let us denote

$$\sum_j \frac{1}{A_{i,j}} = n_i \langle A_{i,j}^{-1} \rangle \quad (2.16)$$

$$\alpha_{i,j} = \langle A_{i,j}^{-1} \rangle - A_{i,j}^{-1} \quad (2.17)$$

then

$$\frac{1}{\lambda_i} = -(\langle A_{i,j}^{-1} \rangle + n_i^{-1} C_i^*) \quad (2.18)$$

Using the constant λ_i of (2.18), (2.14) results in

$$\gamma_{i,j} = n_i^{-1} C_i^* + \alpha_{i,j} \quad (2.19)$$

This solution has a simple meaning: if all users have the same spectral efficiency from the station they are connected to, then each user receives an equal share C_i^*/n_i of the station's resources. In a general case when the spectral efficiency is different, a user located at a greater distance from the station and thus has a smaller than average spectral efficiency $A_{i,j}$, receives a less than average bandwidth $\gamma_{i,j}$.

Once we found $\gamma_{i,j}$ for station i , we can find the throughput between this station and its parent station l :

$$r_{l,i}^B = \sum_j r_{i,j}^A = \sum_j (n_i^{-1} C_i^* + \langle A_{i,j}^{-1} \rangle - A_{i,j}^{-1}) A_{i,j}$$

$$\begin{aligned}
r_{l,i}^B &= (n_i^{-1}C_i^* + \langle A_{i,j}^{-1} \rangle) \sum_j A_{i,j} - \sum_j A_{i,j}^{-1} A_{i,j} \\
r_{l,i}^B &= (n_i^{-1}C_i^* + \langle A_{i,j}^{-1} \rangle)n_i \langle A_{i,j} \rangle - \sum_j 1 \\
r_{l,i}^B &= C_i^* \langle A_{i,j} \rangle + n_i (\langle A_{i,j} \rangle \langle A_{i,j}^{-1} \rangle - 1)
\end{aligned} \tag{2.20}$$

Let us denote

$$\xi_i = n_i (\langle A_{i,j} \rangle \langle A_{i,j}^{-1} \rangle - 1) \tag{2.21}$$

then

$$r_{l,i}^B = C_i^* \langle A_{i,j} \rangle + \xi_i \tag{2.22}$$

Using (2.5) and (2.22), $\delta_{l,i}$ for each penultimate station i can be expressed as:

$$\delta_{l,i} = B_{l,i}^{-1} (C_i^* \langle A_{i,j} \rangle + \xi_i) \tag{2.23}$$

Considering the constraint in (2.10), and knowing $\delta_{i,k}$, it is easy to find $\gamma_{i,j}$ for each penultimate station by analogy with the previous solution (2.19):

$$\begin{aligned}
\gamma_{i,j} &= n_i^{-1} \left[C_i^* - \sum_k \delta_{i,k} \right] + \alpha_{i,j} \\
\gamma_{i,j} &= n_i^{-1} (C_i^* - D_i) + \alpha_{i,j}
\end{aligned} \tag{2.24}$$

where

$$D_i = \sum_k \delta_{i,k} \tag{2.25}$$

Then the throughput between this penultimate station and its parent station l can be found as follows:

$$r_{l,i}^B = \delta_{l,i} B_{l,i} = \sum_j r_{i,j}^A + \sum_k r_{i,k}^B$$

$$r_{l,i}^B = \sum_j \gamma_{i,j} A_{i,j} + \sum_k \delta_{i,k} B_{i,k} \quad (2.26)$$

$$r_{l,i}^B = \left[\left(C_i^* - \sum_k \delta_{i,k} \right) \langle A_{i,j} \rangle + \xi_i \right] + \sum_k \delta_{i,k} B_{i,k} \quad (2.27)$$

$$r_{l,i}^B = (C_i^* \langle A_{i,j} \rangle + \xi_i) + \sum_k \delta_{i,k} (B_{i,k} - \langle A_{i,j} \rangle) \quad (2.28)$$

Recall that for this penultimate station i and each station k that is a child of i

$$\delta_{i,k} B_{i,k} = C_k^* \langle A_{k,m} \rangle + \xi_k \quad (2.29)$$

therefore

$$\delta_{l,i} = B_{l,i}^{-1} (C_i^* \langle A_{i,j} \rangle + \xi_i) + \sum_k \delta_{i,k} B_{i,k} (1 - \langle A_{i,j} \rangle B_{i,k}^{-1}) \quad (2.30)$$

$$\delta_{l,i} = B_{l,i}^{-1} \left[(C_i^* \langle A_{i,j} \rangle + \xi_i) + \sum_k (C_k^* \langle A_{k,m} \rangle + \xi_k) (1 - \langle A_{i,j} \rangle B_{i,k}^{-1}) \right] \quad (2.31)$$

Let us denote

$$\psi_{i,k} = 1 - \langle A_{i,j} \rangle B_{i,k}^{-1} \quad (2.32)$$

then we obtain for the penultimate station i and its parent l

$$\delta_{l,i} = B_{l,i}^{-1} \left[(C_i^* \langle A_{i,j} \rangle + \xi_i) + \sum_k \psi_{i,k} (C_k^* \langle A_{k,m} \rangle + \xi_k) \right] \quad (2.33)$$

Continuing the above recurrent calculations, we can move up the tree of stations and calculate all $\delta_{i,k}$, which would give us all D_i , and finally all $\gamma_{i,j}$.

The solution can be written down in a more compact form by using a matrix notation. Let us define a vector \mathbf{C}^* with components C_i^* (we will write, $\mathbf{C}^* = \{C_i^*\}$), vectors $\mathbf{D} = \{D_i\}$, $\boldsymbol{\xi} = \{\xi_i\}$, diagonal matrix $\mathbf{A} = \{\text{diag} \langle A_{i,j} \rangle\}$ (with elements $\langle A_{i,j} \rangle$ on the main diagonal and all

other elements being zeros), matrix $\widehat{\mathbf{B}} = \{B_{i,k}^{-1}\}$ whose only nonzero elements are $B_{i,k}^{-1}$, matrix $\Psi = \{\psi_{i,k}\}$ whose elements $\psi_{i,k} = 1 - \langle A_{i,j} \rangle B_{i,k}^{-1}$ may only be nonzero when $B_{i,k}^{-1}$ is nonzero, diagonal matrix $\widehat{\mathbf{N}} = \{\text{diag} \langle n_i^{-1} \rangle\}$, whose diagonal elements will be set to zero if $n_i = 0$, and identity matrix \mathbf{I} . All vectors are column vectors of length N_S , and all matrices are square matrices $N_S \times N_S$. Then the above equation (2.25) for D_i takes the form:

$$\mathbf{D} = \widehat{\mathbf{B}}(\mathbf{I} + \Psi)(\mathbf{A}\mathbf{C}^* + \xi) \quad (2.34)$$

Then we can define the vector

$$\mathbf{\Gamma} = \widehat{\mathbf{N}}(\mathbf{C}^* - \mathbf{D}) \quad (2.35)$$

Based on (2.24), finally for each station i and each user j connected to it,

$$\gamma_{i,j} = \Gamma_i + \alpha_{i,j} \quad (2.36)$$

This solves the problem, provided that C_i^* and $x_{i,j}$ are known. Since the locations and spectral efficiency of the stations and users are known, the variable $x_{i,j}$ uniquely defines n_i , $A_{i,j}$ and the variables derived from them ($\alpha_{i,j}$, ξ_i , $\psi_{i,k}$).

2.4.2 Performance Measurements

The performance of our algorithms is evaluated based on user average throughput and fairness among users as defined below:

2.4.2.1 Average throughput:

The user average throughput is defined as the average of received user throughputs, where T is the total simulation time. It can be expressed as follows:

$$AvgT_j = \frac{1}{T} \sum_{t=1}^T \sum_{i=1}^{N_S} r_{i,j}^A \quad (2.37)$$

2.4.2.2 Fairness index:

Jain's fairness index, which indicates the degree of satisfaction of different users in the system, highlights the performance of the algorithm with regards to users' throughput.

$$FI_{Jain} = \frac{\left(\sum_{j=1}^M U_j\right)^2}{M \sum_{j=1}^M U_j^2} \quad (2.38)$$

2.5 Proposed Resource Allocation and relay Selection Algorithm

To maximize the utility function relative to C^* and $x_{i,j}$, a two-stage algorithm was developed to address the joint resource allocation and relay selection problem in multi-hop relay networks under backhaul and capacity limitation constraints. In the following algorithm, the optimization problem (2.9) can be solved to find a sub-optimal solution that maximizes U using the following stages: *Stage 1*: find a sub-optimal C^* resource allocation using an analytical approximation; *Stage 2*: find a sub-optimal $x_{i,j}$ user distribution between stations using a heuristic process. The details of the two stages are presented in the following two sub-sections.

2.5.1 Stage1: Fast Approximation Algorithm for Resource Allocation

Earlier, we expressed the utility function U through components of vector C^* . The step of C^* optimization is the most time-consuming part, therefore, in this stage we will perform an optimization of C^* by analytical approximation as presented below:

Using the equation (2.36), (2.6) results in

$$\begin{aligned} U(\boldsymbol{\gamma}) &= \sum_{i,j} x_{i,j} \ln(1 + \gamma_{i,j} A_{i,j}) \\ U(\boldsymbol{\gamma}) &= \sum_{i,j} x_{i,j} \ln(1 + (\Gamma_i + \alpha_{i,j}) A_{i,j}) \\ U(\boldsymbol{\gamma}) &= \sum_{i,j} x_{i,j} \ln(A_{i,j}) + \sum_i n_i \ln(\Gamma_i + \langle A_{i,j}^{-1} \rangle) \end{aligned}$$

Note that the first sum does not depend on C^* , while the second sum does not depend on j . This can be checked numerically using practical parameters of the system that $\Gamma_i \gg \langle A_{i,j}^{-1} \rangle$. Then the vector derivative of U with respect to C^* can be written down in a simple form using this matrix notation:

$$\nabla U \approx (\mathbf{I} - \mathbf{H}^T)\beta \quad (2.39)$$

where

$$\beta_i = 1/\Gamma_i \quad (2.40)$$

and

$$\mathbf{H} = \widehat{\mathbf{B}}(\mathbf{I} + \Psi)\mathbf{A} \quad (2.41)$$

The maximum of U under the conditions stated above should correspond to a conditional minimum of the norm $|\nabla U|$. We have a simple matrix expression for Γ but not for β . Since we are looking for a simple, approximate solution of the optimization problem, it is reasonable to assume that the term $|(\mathbf{I} - \mathbf{H}^T)\mu|$ will have an extremum, at least approximately, when $|(\mathbf{I} - \mathbf{H}^T)^{-1}\Gamma|$ has an extremum. Now, this conditional extremum can be determined exactly because $|(\mathbf{I} - \mathbf{H}^T)^{-1}\Gamma|$ is a bilinear form in C^* . We will take an assumption that the BS is working at full capacity, therefore $C_1^* = C_1$. After a lengthy yet straightforward derivation, the optimal Γ can be written by a semi-empirical equation as $\Gamma = \mu\tilde{\Gamma}$, where

$$\tilde{\Gamma} = (\mathbf{I} - \mathbf{H}^T)^{-1}\mathbf{N}(\mathbf{I} - \mathbf{H})\tilde{\mathbf{N}}(\mathbf{I} - \mathbf{H})^T\mathbf{e}_1 \quad (2.42)$$

where \mathbf{e}_1 is a vector with the first component equal to 1 and all other components equal to 0, μ is the Lagrange multiplier that can be found from the following condition:

$$\mu = \frac{C_1 + ((\mathbf{I} - \mathbf{H})^{-1}\tilde{\xi})_1}{((\mathbf{I} - \mathbf{H})^{-1}\tilde{\mathbf{N}}\tilde{\Gamma})_1} \quad (2.43)$$

and \mathbf{N} is a diagonal matrix with values n_i on the main diagonal. Once μ is found, we also obtain the approximate theoretical values for C^* and $\gamma_{i,j}$ as follows:

$$C^* = (\mathbf{I} - \mathbf{H})^{-1}(\mu \mathbf{N}\tilde{\Gamma} - \xi) \quad (2.44)$$

$$\gamma_{i,j} = \mu \tilde{\Gamma}_i + \alpha_{i,j} \quad (2.45)$$

2.5.2 Stage 2: Greedy Algorithm for Relay Selection

The following is a simple iterative heuristic algorithm for utility function maximization. The algorithm will make an initial approximation by connecting each user to its nearest station. This might lead to some relay stations being overloaded, whereas others may carry a load below capacity. For each optimal C^* that we found earlier in *stage 1*, we additionally seek to optimize $x_{i,j}$ by shifting some users to different stations in an attempt to further maximize U . Thus we obtained a new set of user-station connections $x_{i,j}$, and for that set we will optimize C^* again. Such alternating iterations continued until U reached an apparent maximum.

The relay selection process can be implemented by disconnecting user j from a station i , then connecting it to station i' , then optimizing the system and finding the change ΔU . This process would enable us to calculate all ΔU for each user j and each station i within a certain radius from user j . These values could then be used to shift users between stations so that $\Delta U > 0$ for every shift. The iterations could continue until the relative increase in the utility function U compared to the previous iterations becomes smaller than a predefined ϵ . The same procedure should be followed when the users are moving. Each iteration will then take into account the new coordinates of each user, assuming that the users will not move too far within the short time between iterations. Then the result of each iteration that optimized the system for the previous set of user coordinates will be considered a starting point for optimization with the new coordinates.

Algorithm 2.1 Resource allocation and relay selection algorithm

1. {Initialization}
2. $x_{i,j}$ (selections are based on received signal strength)
3. $\mathbf{C}^* = \mathbf{C}$ (maximum bandwidth)
4. {Main Iteration}
5. **for** each iteration $n \leq N$ **do**
6. calculate $\mathbf{A}, \langle A_{i,j} \rangle, \langle A_{i,j}^{-1} \rangle, \mathbf{\Gamma}, \alpha_{i,j}, \gamma_{i,j}$
7. calculate U_n
8. calculate $\xi, \mathbf{H}, \mathbf{N}, \hat{\mathbf{N}}, \tilde{\mathbf{\Gamma}}, \mu$
9. calculate new analytical $\mathbf{C}^*, \gamma_{i,j}$
10. **for** each i, j **do**
11. calculate $\{\Delta U | x_{i,j} \rightarrow x'_{i,j}\}$
12. **end for**
13. **for** each i **do**
14. find m largest elements $\{\Delta U | x_{i,j} \rightarrow x'_{i,j}\}$
15. **end for**
16. m users for each i hop: $x_{i,j} \rightarrow x'_{i,j}$
17. calculate $\mathbf{A}, \langle A_{i,j} \rangle, \langle A_{i,j}^{-1} \rangle, \mathbf{\Gamma}, \alpha_{i,j}, \gamma_{i,j}$
18. calculate U_{n+1}
19. **if** $U_{n+1}/U_n - 1 > \varepsilon$ **then**
20. **go to** 6
21. **else**
22. **break**
23. **end if**
24. **end for**

2.6 Numerical Results And Discussion

In this section, we conduct a simulation study to evaluate the performance of our proposed solution for problem (2.9). MATLAB platform was used to simulate our proposed analytical solution developed in the previous sections. In particular, we first validate the simulation model and show some advantages of the multi-hop relay architecture, such as the enhancement of both coverage and capacity, and also of fairness among users. We then compare the performance of our approximate analytical solution using a purely numerical

approach, and finally, we show the overall benefit of our proposed resource allocation and relay selection algorithm. The performance of the proposed algorithm has been evaluated with an urban sparse environment scenario composed of single cell base stations overlaid with 18 relay stations, forming a two-hop relay network. As shown in Figure 2.3, each BS/RS station serves a set of users uniformly distributed in the area with random mobility models and velocity v . On the other hand, we assume that the BS and the RSs have a total transmit power of P_{BS} and P_{RS} respectively where $P_{RS} < P_{BS}$.

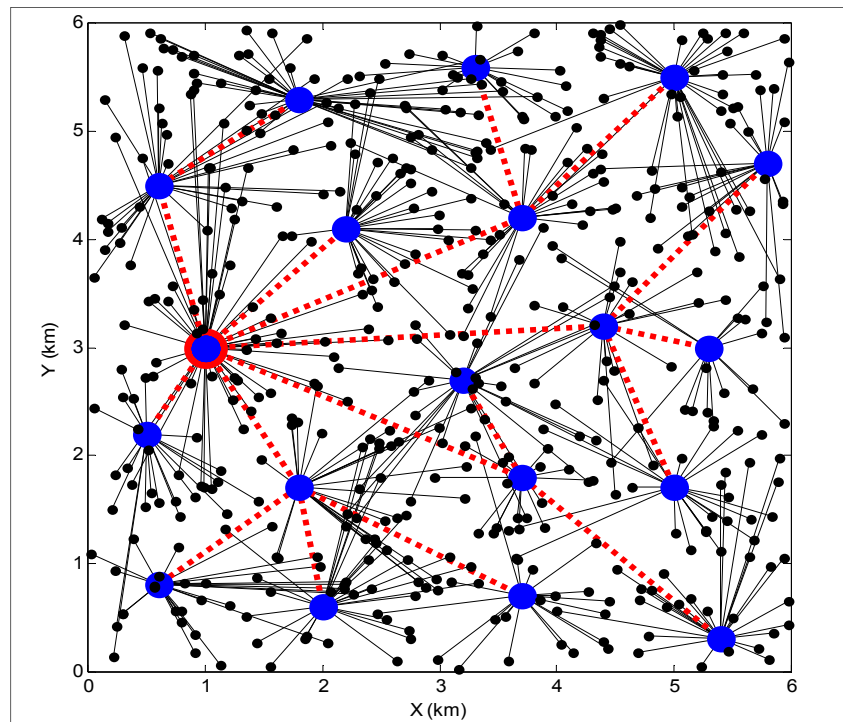


Figure 2.3 Simulation environment

The multi-hop relay network simulation parameters are presented in Table 2.1

Table 2.2 Simulation parameters

Parameter	Value
P_{BS}	43 dBm
P_{RS}	30 dBm
C_i	20MHz (BS) and 5MHz (RS)
m_i	7 (BS) and 0-3 (RS)
N_s	19 (1 BS+18 RS)
M	500 users
v	0.5m/sec
ε	10^{-4}

Figures 2.4 to 2.10 show various performance results and emphasize the effectiveness of our approximate analytical solution versus the numerical one.

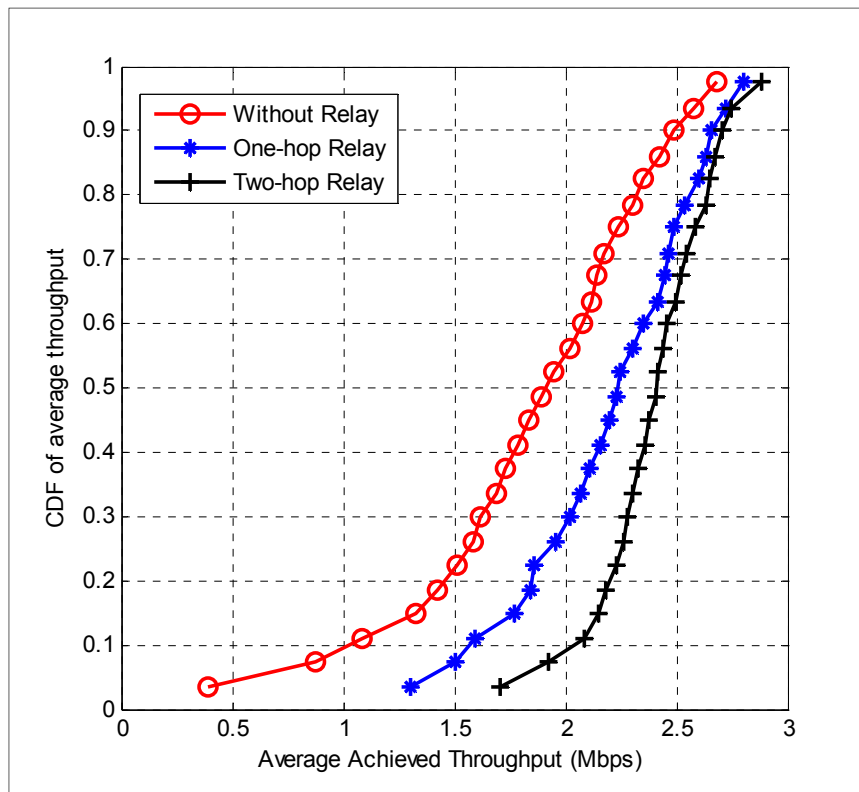


Figure 2.4 Average achieved throughput for different architectures

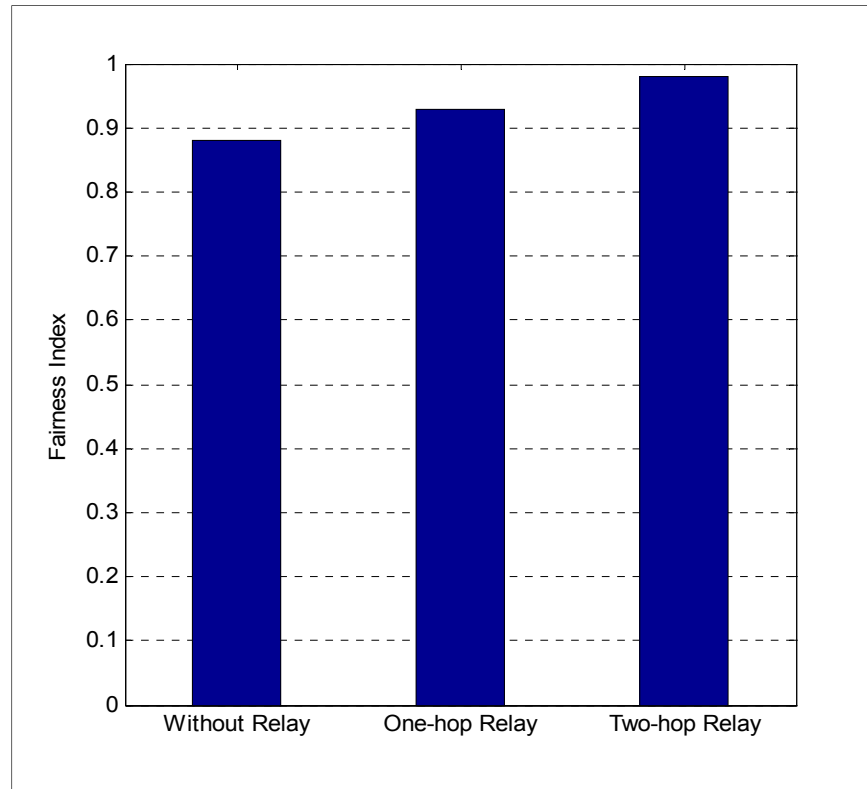


Figure 2.5 Fairness index for different architectures

Figures 2.4 and 2.5 show the achieved throughput and fairness respectively among users for different architectures. It can be seen clearly from Figure 2.4 how relays can be used to enhance the throughput and extend the coverage areas of BS. The two-hop relay architecture provides the best performance in terms of throughput, followed by the one-hop relay architecture, when compared to the conventional architecture without relay.

Figure 2.5 shows the improvement of fairness among users when using relay stations, and particularly in the case of multi-hop relay architecture. This occurs since relay stations are usually deployed at the boundaries of the base station coverage area to fulfill the throughput requirements of the users at the cell edges.

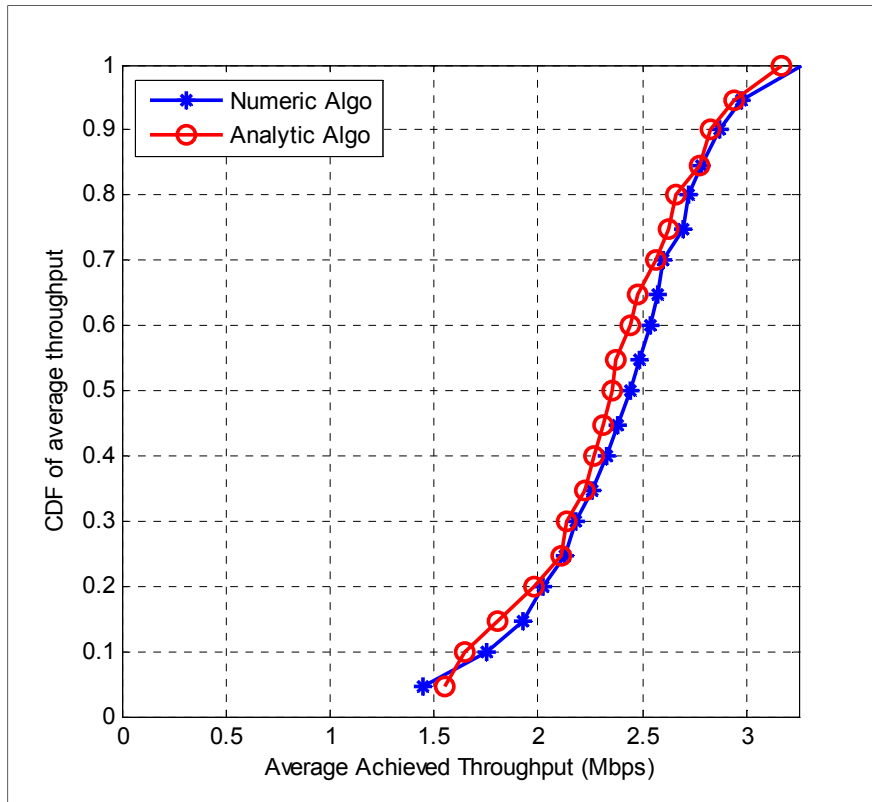


Figure 2.6 Average achieved throughput

Figure 2.6 shows the average achieved throughput of our proposed algorithm compared to that of the numerical algorithm. It can be seen that the performance of our algorithm tends to be closer to the global optimum represented by the numerical algorithm. This is especially true with a low value of M as illustrated in Figure 2.7.

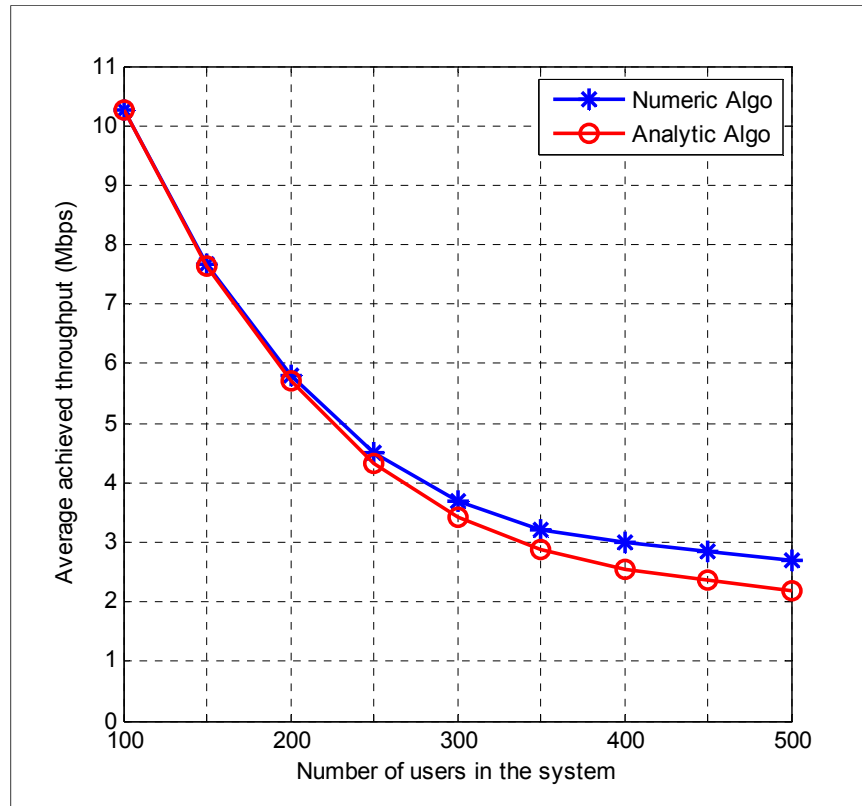


Figure 2.7 Average achieved throughput per user density

Figure 2.7 describes how the average achieved throughput is affected by the number of users in the system. As observed from this graph, the throughput for the analytic and numeric algorithms are significantly affected by the increase of the number of users in the system.

In Figure 2.8, the measure of the computational complexity in terms of execution time vs. number of stations is presented. We compared the purely numerical optimization of C^* and $x_{i,j}$ to theoretical calculation of C^* based on our proposed algorithm. The proposed algorithm clearly outperforms the numerical algorithm, especially when presented with high concentrations of relay stations. As observed from this graph, the purely numerical algorithm can be categorized as a highly complex algorithm since the execution time grows exponentially with the number of relay stations in the system. However, the proposed algorithm has low computational complexity as it tends to increase linearly with number of relay stations in the system.

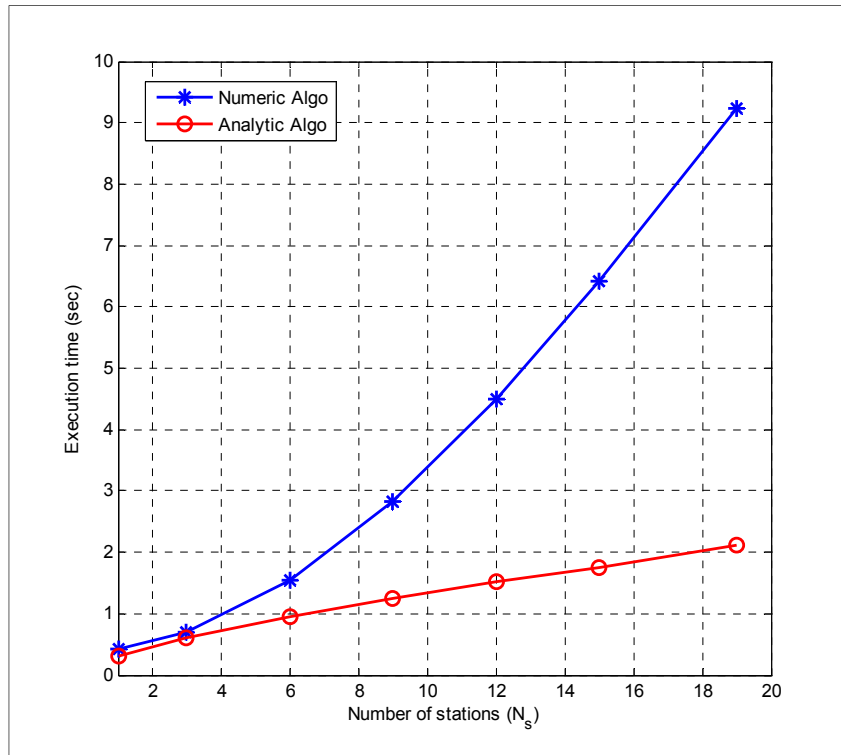


Figure 2.8 Total execution time vs. the number of stations

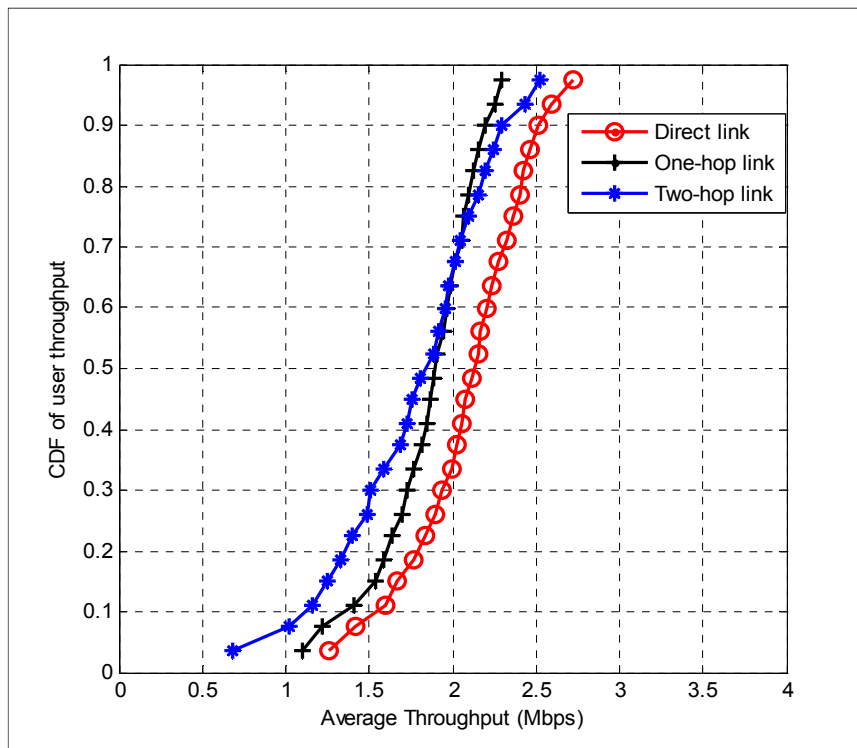


Figure 2.9 Average achieved throughput per number of hops

Figure 2.9 depicts the comparative average throughput performances for different types of connection link: direct, single-hop, and two-hop. It can be seen that the number of hops does not have a large impact on the achieved throughput. This model's result lies in the concave nature of the utility function $u_{ij} = \ln(1 + r_{i,j}^A)$, which has a goal of maximizing the system throughput while considering the fairness among users connected through different hops.

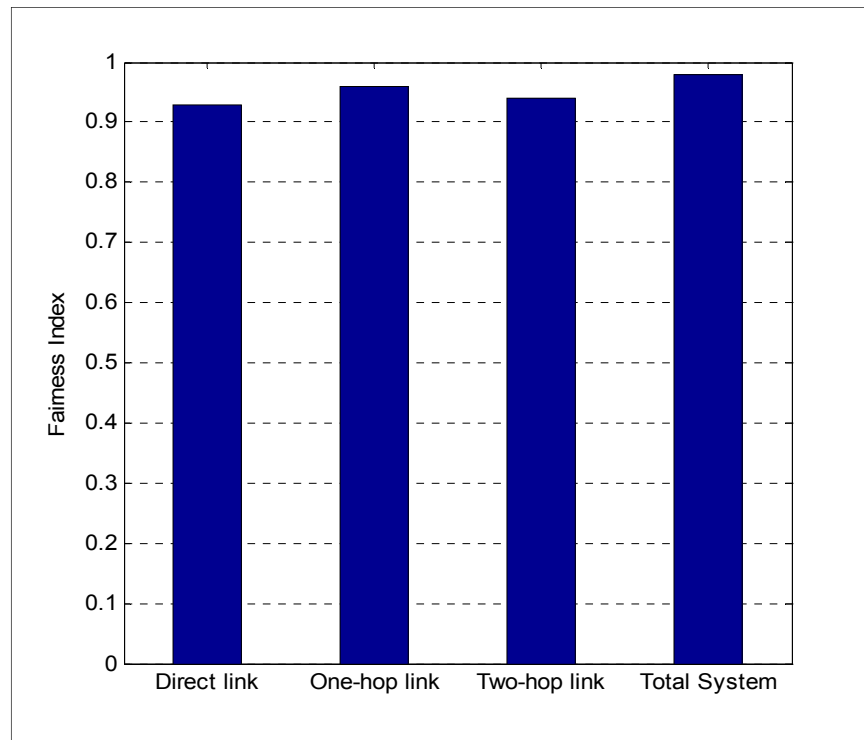


Figure 2.10 Fairness index per type of connection link

Figure 2.10 shows the fairness index among users for different types of links in the system. The fairness index exceeds 90% whenever users move inside the network through different levels of hops concentration. The fairness index metric for the total system is equal to 98%, which confirms that our utility function corresponds to proportional fairness (PF) among all users in the system.

2.7 Conclusion

This paper studies the joint optimization of resource allocation and relay selection in a multi-hop relay downlink network. An optimization framework for maximizing the total user satisfaction of the system under backhaul and capacity limitation constraints was proposed and an analytical solution was presented. However, solving such an optimization problem is difficult, especially for large-scale multi-hop relay networks. Therefore, we implemented and tested a technique to find near-optimal solutions by combining a fast analytical approximation with heuristic methods. The proposed algorithm maximizes the total user satisfaction by jointly selecting the best relay station for each user and optimally allocating the resources to each station such that a low computational complexity can be achieved at the cost of a reasonable performance loss in terms of throughput and fairness compared to the numerical solution. In future work, we will address the call admission control issues and the quality of service support in multi-hop relay networks.

CHAPITRE 3

MDP-BASED JOINT PATH RELAY SELECTION IN 5G MULTI-HOP RELAY NETWORKS

Abderrahmane BenMimoune¹ and Michel Kadoch¹

¹Ecole de Technologie Superieure (ETS), University of Quebec
1100 Notre-Dame Ouest, Montreal, Quebec, Canada H3C 1K3

An Article accepted to the Journal of Networks in August 2015

3.1 Abstract

Multi-hop relaying has been considered as a key technology for future wireless communication networks to overcome coverage and capacity problems in 5th generation mobile networks (5G). Recently, there has been increasing interest from 3GPP operators to integrate multi-hop relaying functionalities into LTE-A standards. However, many issues remain to be resolved due to the complexity of the multi-hop relaying paradigm, specifically resource allocation and mobility management. In this work, we focus on the relay-selection problem, in which a user may have in his range several relay stations from which to choose. The conventional selection scheme is based on the channel condition between the relay and the user, such that the user will achieve a high level of throughput. Alternatively, we propose a novel relay selection strategy based on Markov Decision Process (MDP) for multi-hop relay networks. Our goal is to achieve significant performance improvement against legacy, centralized relay selection strategies such as the disjoint-path selection scheme. Simulation results show that our design has the advantage of reducing inter-cell handoff frequency and lowering handoff delay.

3.2 Introduction

The increase in demand and rapid development of wireless communication quality over the past three decades has motivated the 3rd Generation Partnership Project (3GPP) to introduce the Long-Term Evolution (LTE) and LTE-Advanced (LTE-A) cellular networks. LTE and LTE-A include new capabilities to offer sufficient performance to support high quality video streaming and other multimedia services (Akyildiz et al., 2010). One of the LTE challenges is to increase the capacity of networks as well as reduce the cost/bit delivered in order to address the explosive growth in data demand. In LTE-A, heterogeneous networks (HetNets) have been considered as a promising solution to improve spectral bandwidth, efficiency, and mobility support (Long & Hossain, 2007). Heterogeneous networks consist of several macro base stations (BSs) of high power and various small cells of low power such as micro-, pico-, and femto-cells and relay stations (Long & Hossain, 2007). Our study investigates relay stations (RSs) that can be used to extend the LTE-A radio access network in coverage hole, cell edge, and isolated area scenarios.

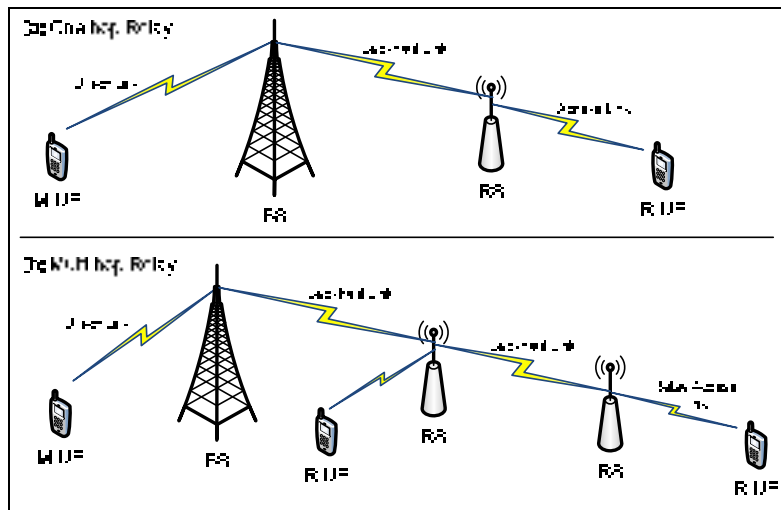


Figure 3.1 Network relay architecture: (a) Single-hop relay (b) Multi-hop relay

An RS has a dual functionality. On one hand, it communicates like user equipment (UE) with the BS through the backhaul link; on the other hand, it communicates like a BS with UE through the access link. A UE can be connected to the network either via an RS that is

wirelessly connected to BS using the LTE radio interface technology or connected directly to BS as in the conventional scenario. As a result, a BS may serve one or several relays in addition to directly serving mobile terminals (Parkvall et al., 2011). Figure 3.1 illustrates how the RSs can be integrated into an LTE-A network (one-hop and multi-hop scenario).

Objective of this work is to develop and evaluate novel handoff algorithms based on a new relay-selection strategy for multi-hop relay networks. In this context, two major issues are addressed: 1) maintaining throughput and 2) ensuring seamless mobility and service continuity to all mobile terminals. The conventional method of relay selection is high-throughput oriented and based on the instantaneous channel condition between relay and user. Alternatively, our work proposes a decentralized solution for relay selection during the handoff process, assisted by the mobile terminal. This joint-path algorithm strategy takes into consideration the existing path and results in minimum resource reservation. This paper presents an extended version of our previous work (BenMimoune et al., 2014).

The paper is organized as follows: The remainder of Section 2 discusses the literature on multi-hop relay networks and some related works. Section 3 describes the system model considered in this paper. Section 4 presents the problem formulation. Section 5 and 6 present the proposed relay-selection scheme and its algorithm respectively. Section 6 describes our simulation and results. Finally, Section 7 presents our conclusions.

3.2.1 Related Works

Performing relay selection in a complex environment is a significant challenge, since an increased number of relays makes the selection problem difficult. Previous studies focused on solving this problem in various scenarios, such as downlink or uplink traffic, single or multiple users, single or multiple relay selection, and a centralized or distributed strategy. Relay selection in a single-hop relay network with a single user has been studied extensively. However, presence of a multi-hop relay and multiple users makes the relay-selection problem more complex due to backhaul dependencies and interactions among users. A downlink relay-selection scheme for a single-hop relay network was presented in (Chang, Sihal,

Xiaowei, & Wuyang, 2011; Mehrjoo, Moazeni, & Shen, 2010), while such a network with an uplink relay-selection strategy was studied in (Ma, Liu, & Guan, 2012). System capacity in a single-hop relay network was analyzed in (Venkataraman, Sinanovic, & Haas, 2008). The authors in (Ikki & Ahmed, 2010) showed the implications of relay-selection mechanism for total system capacity. In (Ann & Kim, 2010), the authors addressed the relay-selection problem in a multi-hop relay network, while such a network was studied for a joint resource-allocation and relay-selection scheme in (Abderrahmane, Fawaz A, Bo, & Michel, 2015), basing the selection strategy on a heuristic algorithm to maximize total user satisfaction. In (Oyman, 2010), the authors proposed grouping users based on location to perform the relay-selection strategy, restricting nearer users to connecting to the base station over a direct connection and users farther away to connecting to the base station in two hops through the closest relay station.

In (BenMimoune Abderrahmane & Kadoch Michel, 2013; Yi, Adve, & Teng Joon, 2007), users selected the relay station that had the maximum signal-to-interference-and-noise ratio (SINR), whereas in (Sadek, Zhu, & Liu, 2006), relay selection was based on the distance between the relay and the base station. (Yang et al., 2009) discussed traditional random and opportunistic schemes. In a random algorithm, the relay station randomly selects users in its service coverage without taking into consideration user location and user achievable throughput. In contrast, the opportunistic scheme lets users choose a relay station according to signal strength. In addition, the authors proposed centralized and distributed relay-selection schemes and evaluated the performance of those algorithms. It is clear that centralized schemes require more signaling overhead but can achieve better performance gains than distributed schemes. (Bletsas et al., 2005) proposed a distributed relay-selection scheme, in which users selected the best relay station based on channel conditions of the end-to-end path. (Hanguan, Ho Ting, & Weihua, 2011) investigated user mobility. In (Jianwei, Zhu, Mung, & Poor, 2008), the authors proposed an auction mechanism based on Signal-to-noise ratio (SNR) and giving each user power to determine relay selection and power allocation by making a bid to maximize utility, with relays being selected to allocate transmission power according to the bids, leading to a distributed algorithm that converges on a Nash equilibrium point. (Yindi & Jafarkhani, 2009) proposed an extension of the single-

relay selection scheme for multiple-relay selection. (Michalopoulos, Karagiannidis, Tsiftsis, & Mallik, 2006) proposed a multiple-relay-selection strategy for choosing stations, achieving a balance between transmission reliability and total energy consumption.

3.2.2 Our Contribution

Most of the existing work on multi-hop relay communications is not suitable for practical applications due to the complexity of the problem, particularly when the network concerned is dense. Therefore, a new relay-selection scheme is necessary to improve handoff performance while producing near-optimal solutions.

This paper describes development and evaluation of a relay-selection scheme for multi-hop relay networks. First, we formulate the problem of relay selection jointly with resource allocation for multi-hop relay networks. Next, we propose a mathematical framework model based on the Markov Decision Process (MDP). Finally, we present an MDP-based relay-selection strategy that considers the relay-station load and the existing radio-link path to improve handoff performance.

3.3 System Model

The system model under consideration is derived from similar models used in Chapter 2 and is composed of two BSs, entirely covering the geographical region and overlaid with 20 RSs to track inter-cell and intra-cell handoff, as depicted in Figure 3.2. An RS cannot have more than one parent but can have several child relays. Each station (either BS or RS) serves a set of users who are uniformly distributed geographically. A minimum distance between two neighboring relays is taken into account to distribute relays effectively in targeted areas based on relay transmission power and the area covered. Different propagation channel models are used for BS and RS transmissions.

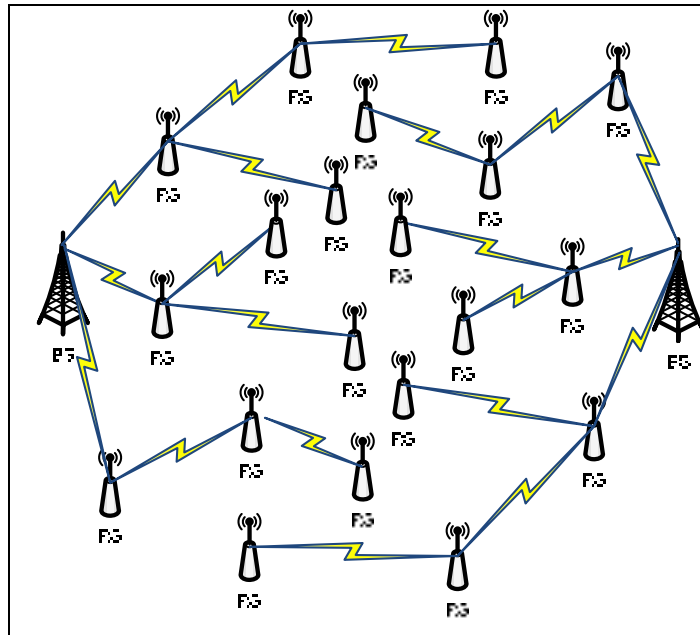


Figure 3.2 Network system model

System total bandwidth is assumed to be divided into orthogonal sub-channels, and resource allocation is considered to be distributed at each RS based on the approach developed in Chapter 2. Our model assumes an infinite backlog in which all stations offer Continuous Bit Rate (CBR) applications to their attached users to use allocated bandwidth fully. The traffic assumed in our scenario is generated by a video streaming application. Since these applications usually are delay-sensitive, it is easy to catch the QoS-level variation based on delay introduced by the inter-cell and/or intra-cell handoff process.

UEs are assumed to be moving randomly and to have intra-relay handoff capabilities. In addition, it is assumed that a system is considered static without arrivals of new calls and departures of existing calls.

3.4 Problem Formulation

This section presents the formulation of the relay-selection problem jointly with resource allocation in multi-hop relay networks, as described in Chapter 2.

3.4.1 Relay Selection Problem Formulation

Let u_{ij} denote the utility function of user j for an allocated resource $\gamma_{i,j}$ from station i . This utility function renders the amount of benefit that the user obtains for various amounts of allocated resource. The utility function for a user j who is connected to station i can be expressed in the following form:

$$u_{ij} = \ln(1 + r_{i,j}^A) \quad (3.1)$$

where $r_{i,j}^A$ is the achievable throughput at user j from station i . The utility function is concave, corresponding to the common Proportional Fairness Objective (PFO) (Andrews et al., 2005), and is suitable for modeling Variable Bit Rate (VBR) services. The objective of station i is to maximize its total satisfaction for the users within its coverage area, given by:

$$U_i = \sum_{j \in n_i} x_{i,j} \ln(1 + r_{i,j}^A) \quad (3.2)$$

where U_i is the total utility of station i , rendered by the summation of the users' utility function within the coverage area. n_i is the set of users connected to station i . We associate the set of variables $\{x_{i,j} | (i = 1, 2, \dots, N_s, j = 1, 2, \dots, M)\}$ to the assignment problem, where $x_{i,j} = 1$ if user j is connected to station i , and $x_{i,j} = 0$ otherwise:

$$\sum_i x_{i,j} = 1, \quad x_{i,j} \in (0, 1), \quad \forall j \quad (3.3)$$

Network throughput is calculated by multiplying the bandwidth assigned by the spectral efficiency used in the macro or relay cells:

$$r_{i,j}^A = \gamma_{i,j} A_{i,j} \quad (3.4)$$

$$r_{i,k}^B = \delta_{i,k} B_{i,k} \quad (3.5)$$

where $r_{i,j}^A$, $\gamma_{i,j}$ and $A_{i,j}$ are the throughput, bandwidth, and spectral efficiency on the access link, respectively, between station i and user j ; $r_{i,k}^B$, $\delta_{i,k}$, and $B_{i,j}$ are the throughput, bandwidth, and spectral efficiency on the backhaul link, respectively, between the parent station i and child RS k .

We are looking to maximize the total utility function U , which depends on the allocated resources $\gamma_{i,j}$:

$$U(\gamma) = \sum_{i=1}^{N_s} \sum_{j=1}^M x_{i,j} \ln(1 + r_{i,j}^A) \quad (3.6)$$

where the total load of each station i in the geographic region cannot exceed the capacity limitation C_i :

$$\sum_{j \in n_i} \gamma_{i,j} + \sum_{k \in m_i} \delta_{i,k} \leq C_i, \quad \forall i \quad (3.7)$$

For each relay station i , the throughput of a backhaul link should be equal to the total throughput of child RSs and served users:

$$\sum_{j \in n_i} r_{i,j}^A + \sum_{k \in m_i} r_{i,k}^B = r_{i,i}^B, \quad \forall i \quad (3.8)$$

To summarize, the joint relay selection and resource-allocation problem in multi-hop relay environments can be expressed by the following optimization problem:

$$\begin{aligned} & \max_{\gamma > 0} U(\gamma) \\ \text{s. t. } & \sum_{j \in n_i} \gamma_{i,j} + \sum_{k \in m_i} \delta_{i,k} \leq C_i, \quad \forall i \\ & \sum_{j \in n_i} r_{i,j}^A + \sum_{k \in m_i} r_{i,k}^B = r_{i,i}^B, \quad \forall i \end{aligned} \quad (3.9)$$

The above optimization problem (3.9) consists of two sub-problems of considerably differing natures and complexities:

1. Find the optimal matrix $X = \{x_{i,j}\}$ that has elements equal to 1 if user j is connected to station i , and is 0 otherwise.
2. Given that X is known, find the optimal resource allocation $\gamma_{i,j}$ and $\delta_{i,k}$.

While an approximate analytical solution to the second sub-problem was given in Chapter 2, the first sub-problem will be addressed in the following section.

3.4.2 Performance Measurements

The performance of our proposed scheme is evaluated based principally on user average throughput, packet loss, number of handoffs, and handoff delay, as defined below:

3.4.2.1 Average throughput

User average throughput is defined as the average of received user throughputs, where T is the total simulation time. It can be expressed as follows:

$$AvgT_j = \frac{1}{T} \sum_{t=1}^T \sum_{i=1}^{N_s} r_{i,j}^A \quad (3.10)$$

3.4.2.2 Handoff delay

Handoff delay is a major criterion for evaluating a handoff algorithm. The handoff delay in our system model can be defined as the sum of resource-reservation time at each station participating in the new path, expressed as follows:

$$T_{HO} = \omega T_{RS} + \alpha T_{BS} \quad (3.11)$$

where T_{BS} and T_{RS} represent resource-reservation time at the BS and RS, respectively; the factor ω represents the number of new RSs participating in the radio-link path; the factor α tracks the handoff type, defined as follow: $\alpha = 1$ in the case of inter-cell handoff, and $\alpha = 0$ for the intra-cell handoff scenario.

3.5 Proposed relay-Selection Scheme

Conventionally, selection of the best relay is based on the instantaneous channel condition between the station and the user, such that the user will have a high throughput. Therefore, the conventional scheme does not take into account the backhaul link limitation and the resources needed when choosing the best relay. The aim is to develop a scheme for relay selection during the handoff process. The proposed relay-selection algorithm is controlled by a type of mobile-assisted, controlled handoff in which the relay-selection scheme gives preference to the set of relays that lie on the existing path, in addition to the received throughput. Compared to the disjoint path, the joint-path algorithm takes into consideration the existing path to reach the donor BS with minimum resource reservation, as illustrated in Figure 3.3.

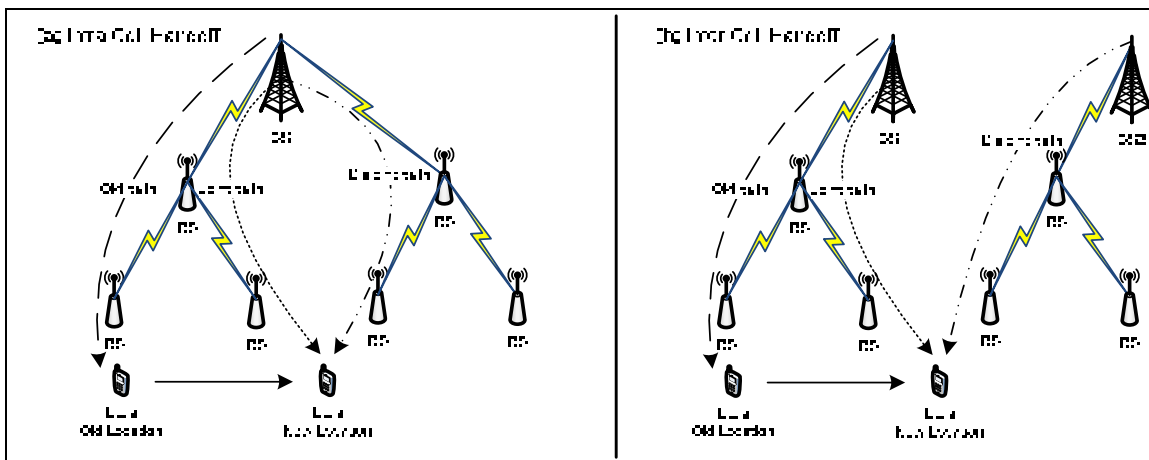


Figure 3.3 Handoff scenarios in multi-hop relay architecture: (a) Intra-cell handoff
(b) Inter-cell handoff

Our proposed solution has the following features: 1) It is a decentralized algorithm, in which each relay participates in path selection and performs its resource reservation with base station cooperation; 2) The UE plays an active role in RS selection and resource reservation of the new path to satisfy its required bandwidth; 3) Multi-hop relay paths are selected based on donor BS. Hence, the algorithm suggests the challenges to be treated differently than in existing approaches (based on a central controller) used in a conventional cellular network.

Since we need a computationally efficient algorithm that will perform relay selection in real time, given the ongoing changes in users' positions, we propose an MDP with a continuously updated transition matrix. Our MDP is a 5-tuple (S, A, P, R, γ) in which the state S , the action A , the probability P , the reward R , and the discount factor γ are defined as follows:

3.5.1 The state S

Naturally, it makes sense to consider only stations close enough to each user. Depending on the general pattern of station locations, the number of nearest neighbors N_n for each user could be from 2–5. For the sake of argument, let $N_n = 3$. Therefore, for each user, we will consider the 3 most-likely connections (out of a much greater number of possible connections). Therefore, each user, at any time, could be in one of 3 states: S_j^1 , S_j^2 , and S_j^3 , which denote the fact that user j is connected to the 1st-, 2nd-, or 3rd-nearest station to his current location. Note that as the user moves around the region, the states S_j^1 , S_j^2 , and S_j^3 may denote a connection to different stations at different moments in time. We denote the finite set of states for the total system \bar{S} as the union of the sets of states of all users:

$$\bar{S} = S_1 \cup \dots \cup S_M \quad (3.12)$$

where S_j is the set of S_j^k for all stations k in the system. The state of the system at an instant of time is given by:

$$S = S_1^k \otimes \dots \otimes S_M^l \quad (3.13)$$

3.5.2 The action A

Let A be the finite set of actions. We will define an action for user j as $A_j^{kl}: S_j^k \rightarrow S_j^l$, which denotes a transition from user's state S_j^k to state S_j^l . Then, the total action set for the system \bar{A} is the union of the sets of actions of all users:

$$\bar{A} = A_1 \cup \dots \cup A_M \quad (3.14)$$

where A_j is the set of A_j^{kl} for all k, l stations in the system. This includes actions A_j^{kk} such that the user stayed connected to the same station as before. The action A in the system is given by the action of each user over a period of time:

$$A = A_1^{kl} \otimes \dots \otimes A_M^{mn} \quad (3.15)$$

3.5.3 The reward R

Let the state S of the system be known. Consequently, $X_{i,j}$ is known. Based on (3.6), the utility function corresponding to the state S can be written as follow:

$$U(S) = \sum_{i,j} X_{i,j} \ln(1 + r_{i,j}^A) \quad (3.16)$$

Let user j be in the state S_j^k , and consider an action for this user $A_j^{kl}: S_j^k \rightarrow S_j^l$. The new state S' of the system obtained by the action A_j^{kl} on S can be written as follow:

$$S' = A_j^{kl} \circ S \quad (3.17)$$

where S' differs from S by the state of a single user.

Consequently, the reward per user j of the action A_j^{kl} is calculated as:

$$R_j^{kl} = U(A_j^{kl} \circ S) - U(S) \quad (3.18)$$

Further, the total reward R of the action A defined in (3.15) on the entire system is given by the sum below:

$$R = R_1^{kl} + \dots + R_M^{mn} \quad (3.19)$$

3.5.4 The probability P

This is the key element of the algorithm, because it defines how the system will evolve over time and approach the optimal state. We want to maximize the reward, so the simplest solution would be to assign the probability of 1 to the action that has the maximum reward, and 0 to all other actions. However this approach has serious deficiencies. First, the above definition of reward R , defined in (3.19), implicitly assumes that the action for user j_1 has no effect on the reward for user j_2 , which may not be true generally. In addition, we must consider long-term rewards. Choosing the highest possible immediate reward at every step might lock the system in an isolated, local minimum of function $U(S)$. To avoid such a situation, we need the Markov chain to visit, albeit less often, states that are less than optimal. However, the more-optimal states must have a higher probability of transition into them. The expected behavior of the Markov chain can be modeled in the same way as the behavior of a thermodynamic system. In thermodynamics, the probabilities of discrete steps (actions) in such a system are described by the Maxwell-Boltzmann distribution, which is a solid model that has been extended to investigate physical complex systems. Following the above analogy, we suggest the formula for the probability of action A_j^{kl} in the following form:

$$P_j^{kl} = P(A_j^{kl}) = \frac{e^{\beta R_j^{kl}}}{\sum_{l=0}^{N_n} e^{\beta R_j^{kl}}} \quad (3.20)$$

where β is a positive parameter (to be discussed below). It can be seen that the higher the reward R_j^{kl} , the larger the probability P_j^{kl} of the action A_j^{kl} , but all other actions for the given user also are possible (they have nonzero probabilities). The sum of all probabilities is equal to 1, as it should be:

$$\sum_l P_j^{kl} = 1 \quad (3.21)$$

Finally, the probability P of the action $A = A_1^{kl} \otimes \dots \otimes A_N^{mn}$ on the entire system is given by the following product:

$$P = P_1^{kl} \times \dots \times P_N^{mn} \quad (3.22)$$

Our algorithm should give preference to switches such that the new RS l , to which the user is switched, can join the old path to BS as the old relay station k ; hence, the following modification of the formula for the probability is suggested:

$$P_j^{kl} = P(A_j^{kl}) = \frac{w_j^{kl} e^{\beta R_j^{kl}}}{\sum_{l=0}^{N_n} w_j^{kl} e^{\beta R_j^{kl}}} \quad (3.23)$$

where $w_j^{kl} = W$ if relay station k and l lie on the same path to the BS, and $w_j^{kl} = 1$ otherwise (disjoint path). The parameter W must be superior than 1 ($W > 1$) to employ the joint-path algorithm, and the larger W , the more the algorithm will prefer the joint-path relays. In the remainder of this paper, we will call the variable W a joint-factor parameter.

3.5.5 The discount factor γ

Let l be a relay station such that R_j^{kl} is the maximum reward for user j , whose current state is S_j^k . It is easy to see that, if $\beta \rightarrow +\infty$, then $P_j^{kl} = 1$ and probabilities of all other actions for this user are 0. As discussed earlier, considerations of long-term rewards requires that such a situation be avoided. If, in the other limiting case, $\beta = 0$, then all probabilities are equal. In this case, the system will perform a random selection with no tendency to optimization. Therefore, β must be positive, but not too small or too large.

Let us denote:

$$\beta = \frac{\gamma}{1-\gamma} \quad \text{where } 0 < \gamma < 1 \quad (3.24)$$

Using the discount factor γ of (3.24), (3.23) results in:

$$P_j^{kl} = P(A_j^{kl}) = \frac{w_j^{kl} e^{\left(\frac{\gamma R_j^{kl}}{1-\gamma}\right)}}{\sum_{l=0}^{N_n} w_j^{kl} e^{\left(\frac{\gamma R_j^{kl}}{1-\gamma}\right)}} \quad (3.25)$$

The Markov chain with such probabilities will tend to strongly prefer short-term rewards if $\gamma \rightarrow 1$, and will tend to yield a weak short-term optimization (but good long-term behavior) when $\gamma \rightarrow 0$. The exact value of γ that would provide the best performance in both the short and long term should be determined experimentally. Its value will depend on the size of the system, user mobility, and available computational resources. A very dynamic system and limited computational resources will require better short-term optimization and, therefore, a larger γ (closer to 1), and vice versa.

3.5.6 State transition diagram of MDP

A single transition of the entire system is defined by a choice of a single transition in each block corresponding to user j , as illustrated in Figure 3.4 with $N_n = 3$.

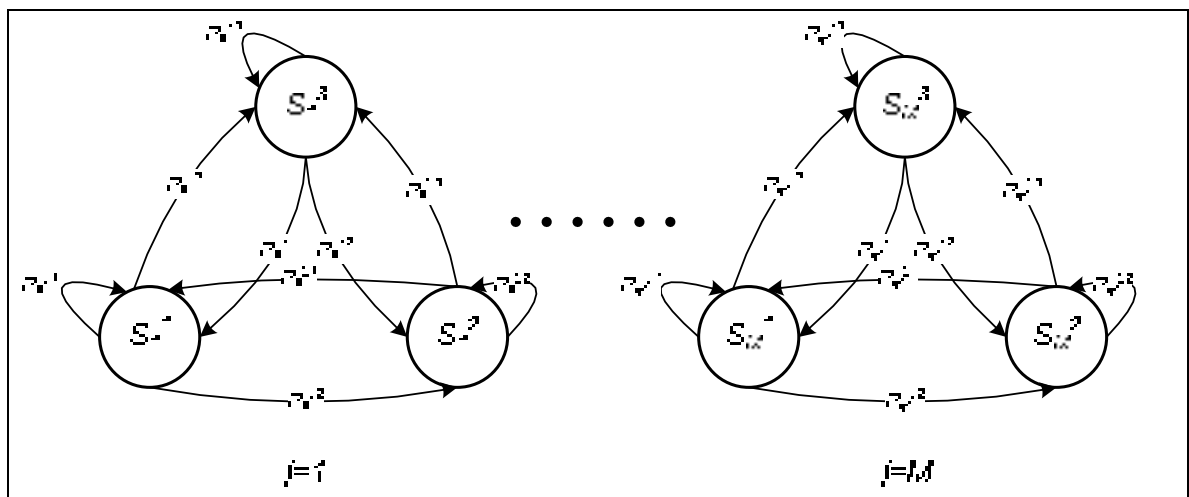


Figure 3.4 MDP state-transition diagram

3.5.7 Matrix of the Markov chain

The matrix of the Markov chain is 3-dimensional and has elements of the form $P = P_1^{kl} \times \dots \times P_N^{mn}$. It can be represented schematically by the following 3-dimensional $3 \times 3 \times M$ matrix (shown schematically for $N_n = 3$):

$$P = \begin{pmatrix} P_1^{11} & P_1^{12} & P_1^{13} \\ P_1^{21} & P_1^{22} & P_1^{23} \\ P_1^{31} & P_1^{32} & P_1^{33} \end{pmatrix} \times \dots \times \begin{pmatrix} P_M^{11} & P_M^{12} & P_M^{13} \\ P_M^{21} & P_M^{22} & P_M^{23} \\ P_M^{31} & P_M^{32} & P_M^{33} \end{pmatrix} \quad (3.26)$$

3.6 Relay-Selection Algorithm

To maximize the utility function relative to $x_{i,j}$, we developed an algorithm to address the relay-selection problem in multi-hop relay networks. In the following algorithm, the optimization problem (3.9) can be solved to find a sub-optimal solution that maximizes U .

Algorithm 3.1 Relay selection algorithm

1. {Initialization}
2. assign numbers $j = 1, \dots, M$ to all users
3. define states S_j^k , $0 \leq k \leq N_n$, $\forall j$
4. set $x_{i,j}$ such that user j is in state S_j^1 , $\forall j$
5. {Main Iteration}
6. **while** (true) **do**
7. calculate $\gamma_{i,j}, \delta_{i,k}$
8. calculate $r_{i,j}$
9. calculate R_j^{km}, P_j^{km} , $\forall j, m$
10. **for** each user j **do**
11. generate uniformly distributed random number $\theta_j \in [0,1]$
12. find l such that $\sum_{m=1}^l P_j^{km} \geq \theta_j$
13. perform action A_j^{kl}
14. **end for**
15. calculate $x_{i,j}$ and $U(S)$
16. define states S_j^k , $0 \leq k \leq N_n$, $\forall j$
17. **end while**

The algorithm will make an initial approximation by connecting each user to its nearest station. This might lead to some RSs being overloaded and others carrying a load below capacity. At Step 6, the loop is infinite in the sense that it should be repeated for as long as the system is active. At Step 7, resources for each link are allocated as proposed in Chapter 2. Subsequently, the throughput, reward, and probability can be determined based on (3.4), (3.18), and (3.25), respectively. After that, the algorithm will perform the set of actions associated with the higher probabilities. Finally, we redefine the states S_j^k for all users, and each iteration will take into account each user's new coordinates, assuming that users will not move too far in the short time between iterations. Then, the result of each iteration that optimized the system for the previous set of user coordinates will be considered a starting point for optimizing with the new coordinates.

3.7 Numerical Results And Discussion

Performance of the proposed relay-selection algorithm was evaluated with a scenario composed of two BSs overlaid with 20 RSs to form one-, two-, and three-hop relay networks, as shown in Figure 3.5. Each BS/RS station serves a set of users uniformly distributed in the area with a random mobility model.

Table 3.1 presents parameters of the multi-hop relay network simulation.

Table 3.1 Simulation parameters

Parameter	Value
P_{BS}	43 dBm
P_{RS}	30 dBm
C_i	20MHz (BS) and 5MHz (RS)
m_i	3 (BS) and 0-2 (RS)
N_s	22 (2 BS + 20 RS)
M	300 users
N_n	3 states
T_{BS}	50 ms
T_{RS}	25 ms
W	1, 5 and 10
γ	0.1, 0.5 and 0.9

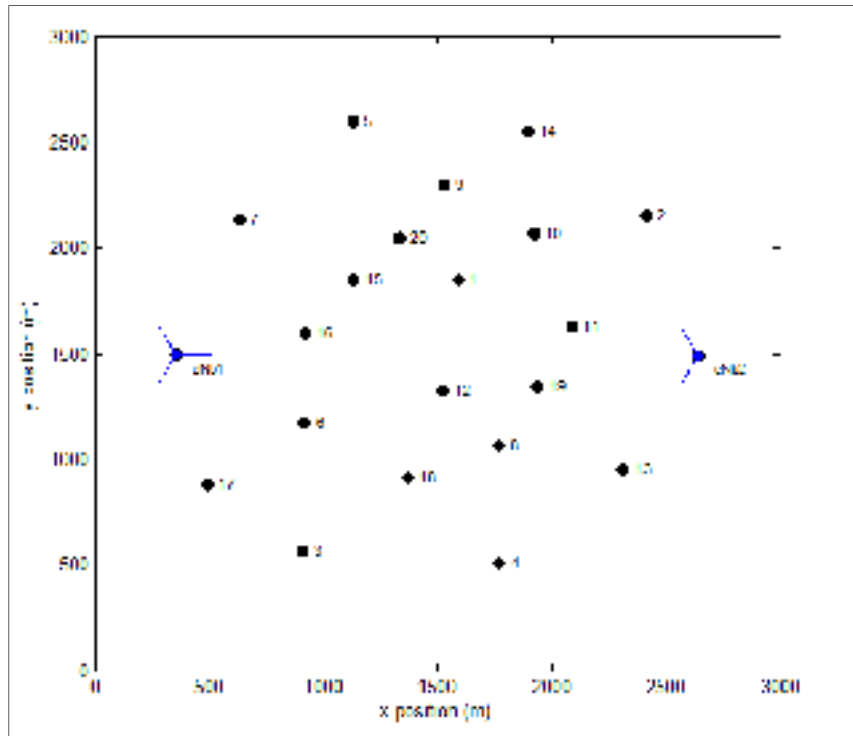


Figure 3.5 Network simulation model

The traffic model used was real-time type, as characterized by parameters in Table 3.2

Table 3.2 Video application parameters

Parameter	Value
Video flow	1.5 Mbps
Maximum delay tolerated	80 ms
Acceptable maximum packet lost	10 %

Figures 3.6 to 3.15 show various performance results and emphasize the effectiveness of our proposed solution with different values of the constants W and γ . In the discussion of results, we will note a low and high joint-path algorithm when $W = 5$ and 10 , respectively, and a disjoint-path algorithm when $W = 1$. Similarly, we will note a low, medium, and high discount factor when $\gamma = 0.1, 0.5$, and 0.9 , respectively.

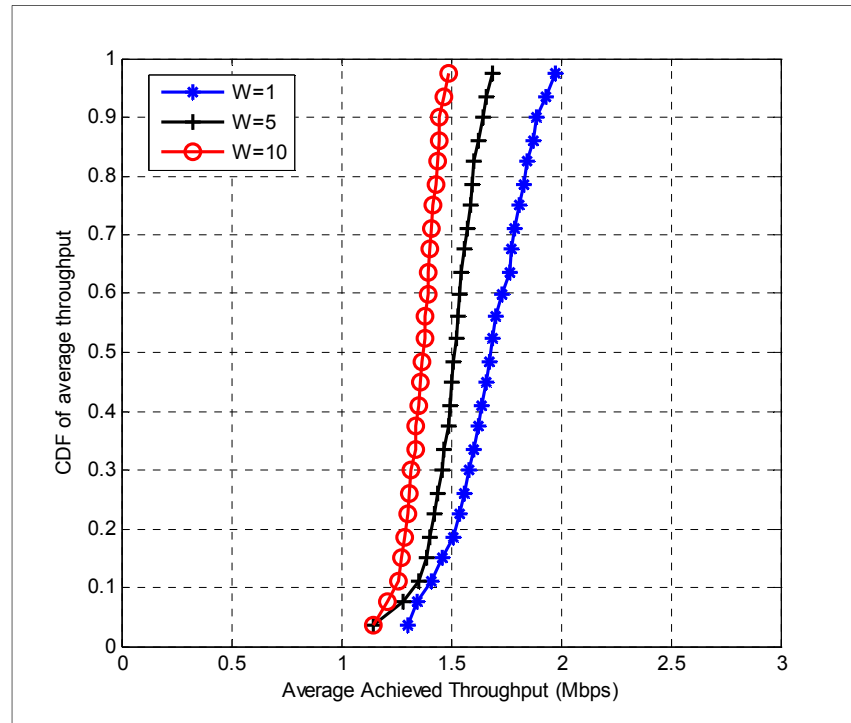


Figure 3.6 UE throughput distribution ($\gamma = 0.1$)

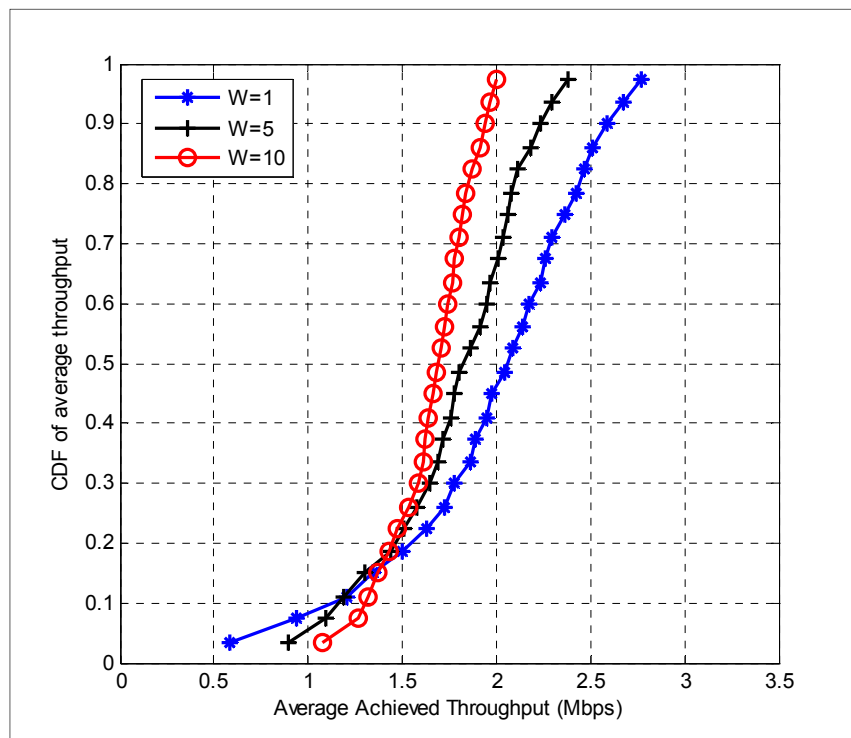


Figure 3.7 UE throughput distribution ($\gamma = 0.5$)

Figures 3.6, 3.7, and 3.8 indicate distribution of throughputs when γ equals 0.1, 0.5, and 0.9, respectively. The three figures show that the average achieved throughput decreased when we increased the joint factor W . Fairness among users also decreased as we increased the discount factor γ . Average users' throughputs were between 1 and 2 Mbps when the discount factor was small and between approximately 0 and 3 Mbps when the discount factor was large (closer to 1).

In Figure 3.6, with a high joint factor ($W = 10$), approximately 95% of users achieved throughput. This does not meet the application throughput requirement, compared to 50% and 20% for $W = 5$ and $W = 1$, respectively. However, in Figures 3.7 and 3.8, we can see that three curves tend to offer the same acceptable throughput rate, with 80% of users getting the required throughput when the discount factor $\gamma = 0.5$, and approximately 65–75% getting it when $\gamma = 0.9$.

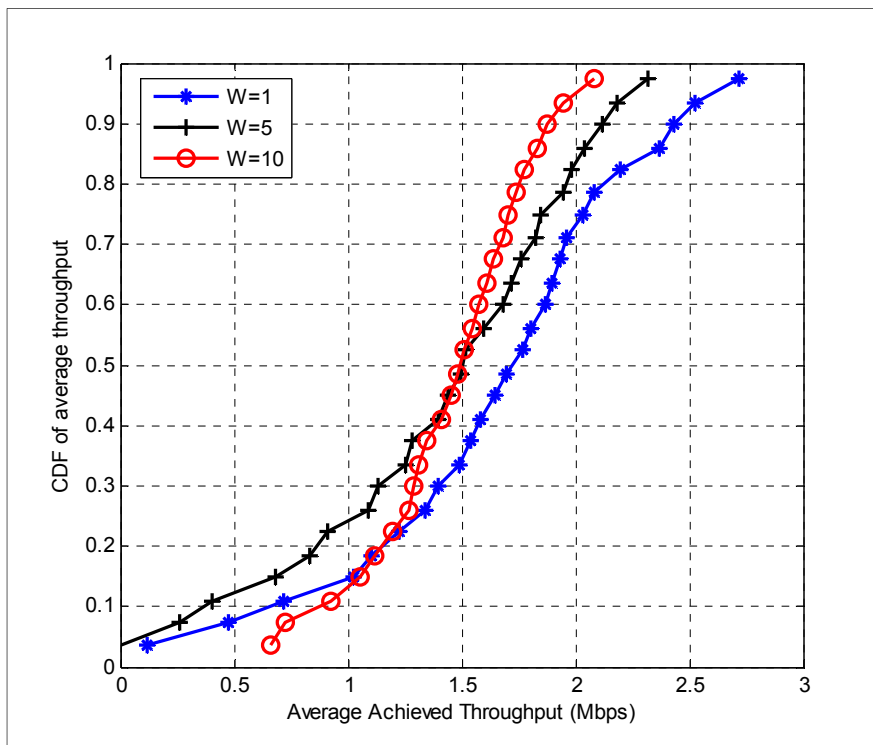


Figure 3.8 UE throughput distribution ($\gamma = 0.9$)

Figures 3.9, 3.10, and 3.11 show the cumulative distribution function (CDF) of the packet-loss ratio with various values of the discount factor. With a low discount factor ($\gamma = 0.1$), the joint-path curves provide a high packet-loss rate compared to the disjoint path, while low and medium joint factors guarantee an acceptable packet-loss ratio (less than 10%). However, with medium and high discount factors, ($\gamma = 0.5$ and $\gamma = 0.9$), the high joint-path algorithm provides the best performance in terms of packet loss when compared to the conventional disjoint-path algorithm, followed by the curve low joint-path algorithm.

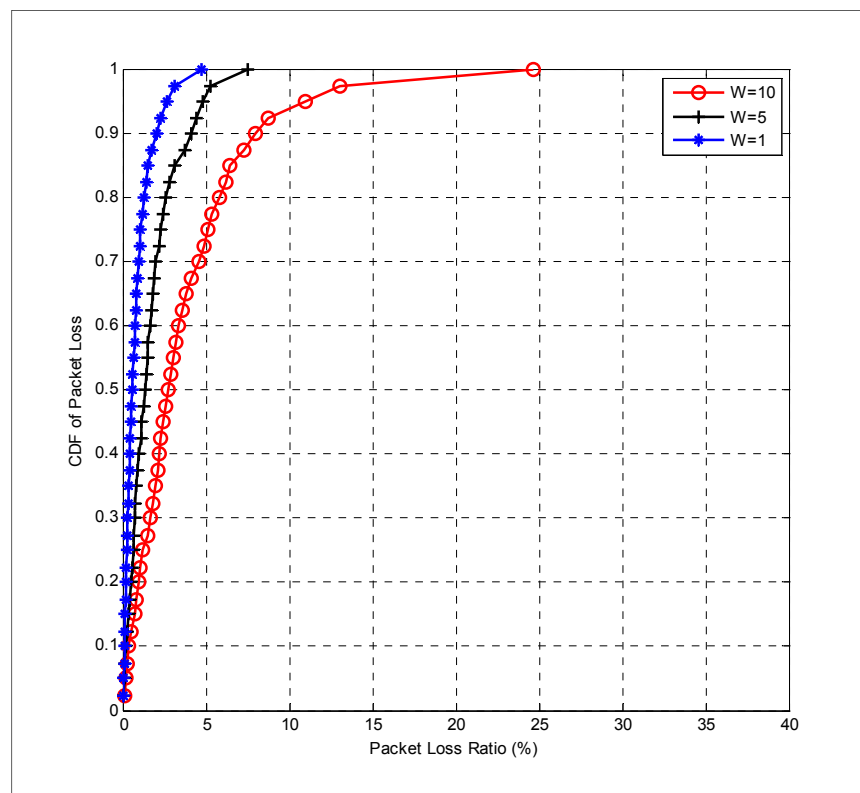
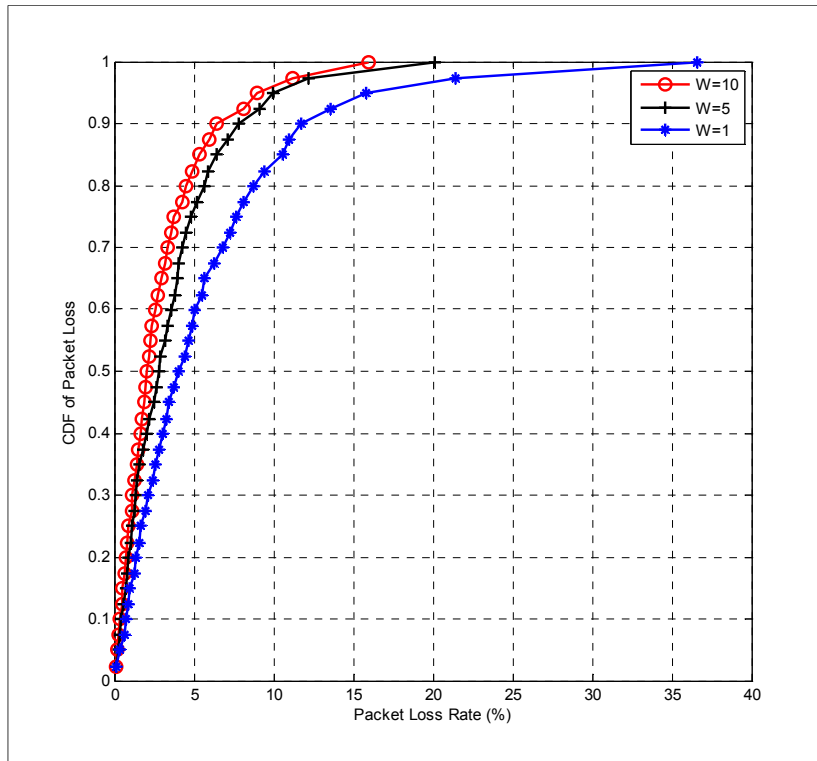
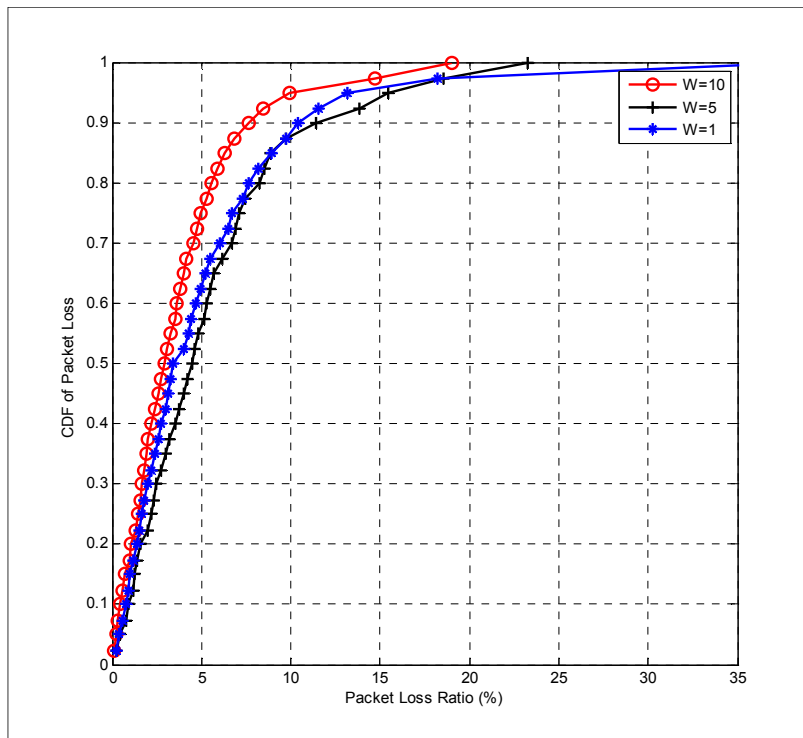


Figure 3.9 Packet loss ratio ($\gamma = 0.1$)

Figure 3.10 Packet loss ratio ($\gamma = 0.5$)Figure 3.11 Packet loss ratio ($\gamma = 0.9$)

Figures 3.12, 3.13, and 3.14 present measure of the average handoff delay. We compared the handoff delay of a disjoint-path algorithm to our proposed joint-path algorithms. It can be seen that the joint-path algorithms clearly outperform the disjoint-path algorithm, especially when presented with low and medium discount factors. This performance can be explained by a reduction of inter-cell handoff and a selection of RSs that lie on the same path to the BS. As seen in Figures 3.12 and 3.13, the two joint algorithms can be categorized as seamless handoff algorithms, since the average handoff delay is less than the maximum delay tolerated by the application (80 ms). However, in the case of a high discount factor (Figure 3.14), it can be seen that for joint- and disjoint-path algorithms that tend to be similar, the handoff delay increases, as the effect of the joint factor is widely reduced, offering more opportunities for the mobile terminal to be handed over to an RS that does not necessary lie on the same old path.

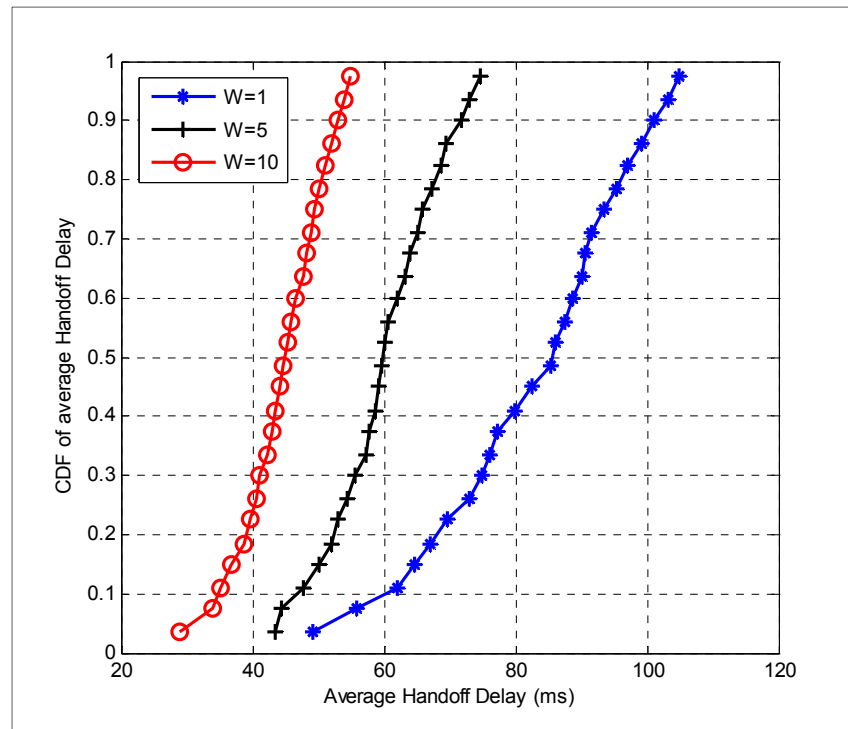


Figure 3.12 Average handoff delay ($\gamma = 0.1$)

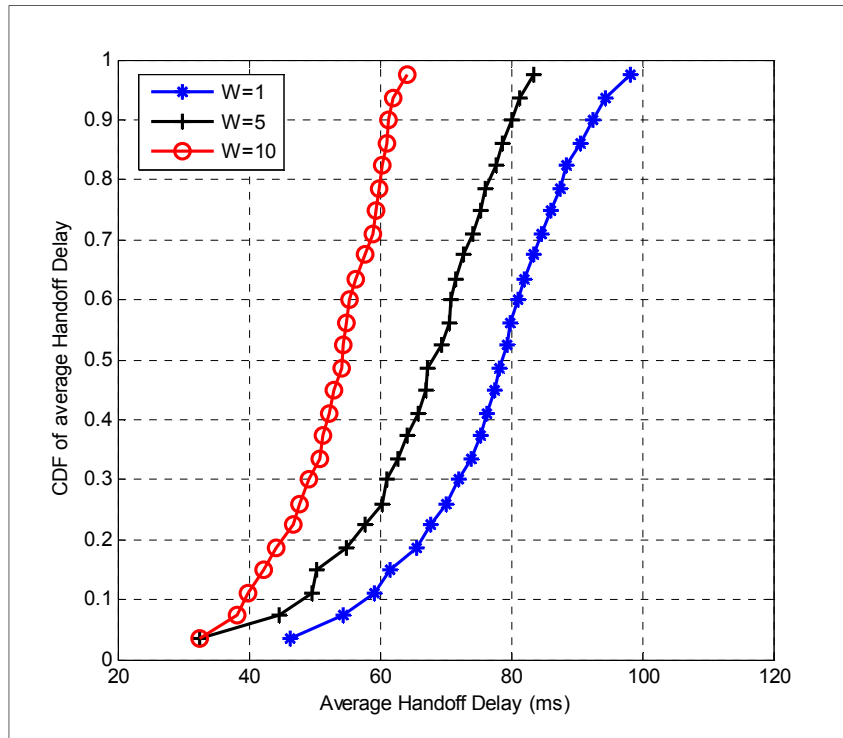
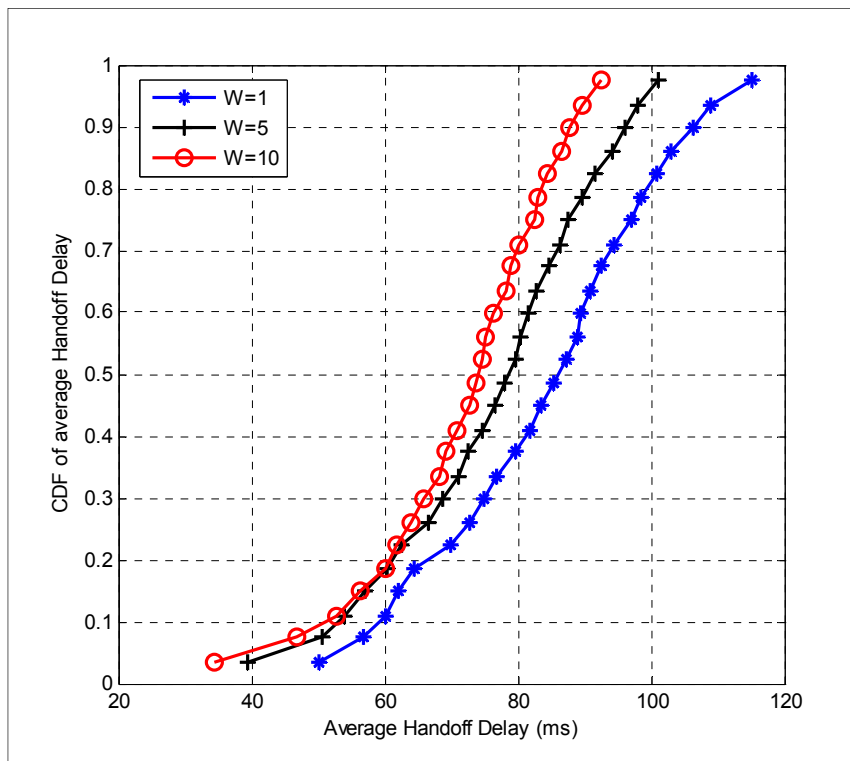
Figure 3.13 Average handoff delay ($\gamma = 0.5$)Figure 3.14 Average handoff delay ($\gamma = 0.9$)

Figure 3.15 illustrates the number of inter-cell and intra-cell handoffs for various relay-selection algorithms when users move around the network. For joint- and disjoint-path algorithms, it can be seen that the increment in the discount factor value increases inter-cell and intra-cell handoff rates, as it reduces the effect of the joint factor, therefore offering more opportunities for the mobile terminal to be handed over to an RS. However, the joint factor directly affects the inter-cell and intra-cell handoff rates, with the high joint-path algorithm clearly giving a better performance in terms of number of handoffs compared to the conventional, disjoint-path algorithm, followed by the low joint-path algorithm.

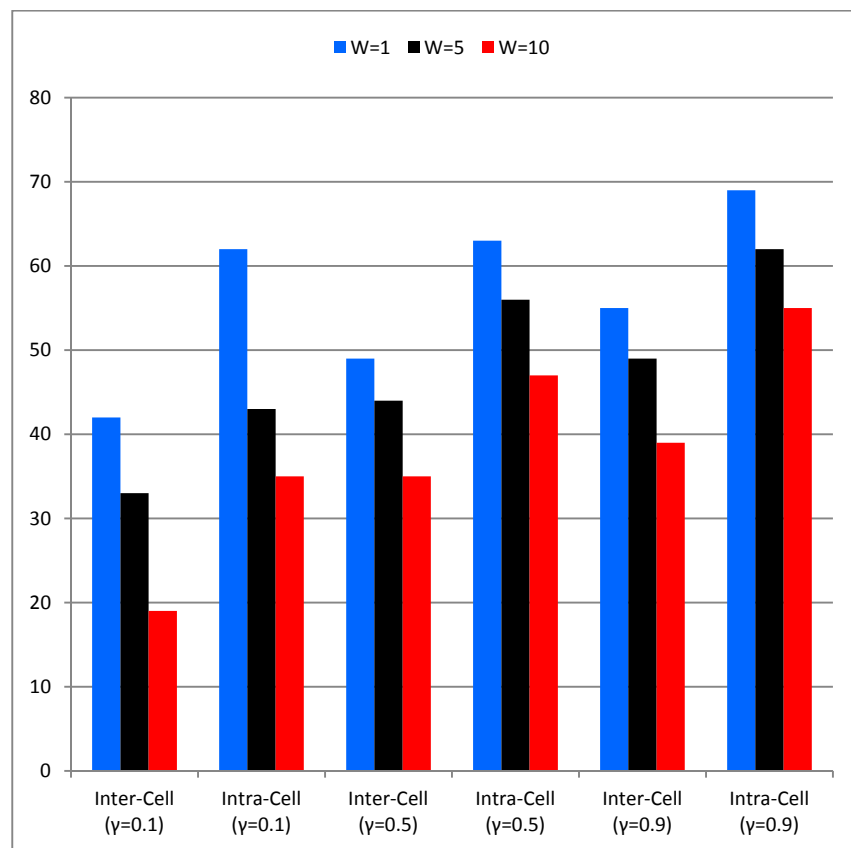


Figure 3.15 Number of inter-cell and intra-cell handoffs per discount and joint factor parameters

Overall results show that modifying parameter values γ and W can significantly increase performance indicators, such as average achieved throughput, packet-loss ratio, number of handoffs, and average delay. It is clear that the proposed algorithm based on a joint-path relay-selection scheme offers better performance than the disjoint-path algorithm. This is

because the proposed algorithm takes into consideration the existing path to the donor BS, which avoids new allocation of resources on each relay in the path and reduces inter-cell handoff and handoff delay. Based on previous results, all schemes have been shown to provide sub-optimal solutions, meaning that for every value of discount and joint-factor parameters there exists a good and bad performance under the same network conditions. The values of $\gamma = 0.1$ and $W = 5$ are a good combination of parameters, providing balanced, acceptable performance in our simulated system model.

3.8 Conclusion

As 3GPP advocated, multi-hop relaying can provide promising coverage extension and throughput enhancement to 5G networks. This paper studied relay selection in a multi-hop relay downlink network. A relay-selection approach based on the Markov Decision Process was proposed to develop a joint-path relay-selection scheme and reduce inter-cell handoff. The performance of our design was evaluated using various parameter settings and was compared to the conventional disjoint-path algorithm. Numerical results showed that better handoff performance can be achieved by selecting a new path that joins with an existing one. Specifically, our proposed scheme minimizes inter-cell handoff, packet loss, and handoff delay at the cost of a reasonable performance loss in terms of throughput compared to the disjoint-path solution. In future work, we will address the call-admission and power-control issues in multi-hop relay networks.

CHAPITRE 4

USER ASSOCIATION-BASED JOINT ADMISSION AND POWER CONTROL FOR HETEROGENEOUS WIRELESS NETWORKS

Abderrahmane BenMimoune¹, Fawaz A. Khasawneh¹ and Michel Kadoch¹

¹Ecole de Technologie Superieure (ETS), University of Quebec
1100 Notre-Dame Ouest, Montreal, Quebec, Canada H3C 1K3

An Article submitted to the Springer Wireless Personal Communications

Journal in June 2015

4.1 Abstract

Heterogeneous networks principally composed of macro-cells overlaid with small cells (e.g., femtocells, pico-cells, and relays) can potentially improve the coverage and capacity of existing cellular networks and satisfy the growing demands of data throughput. In HetNets, small cells play a key role in offloading user data traffic from congested macro-cells and extending the limited coverage of macro-cells. However, the use of small cells is still impeded by the issues of coexistence and efficient operation, as small cells are characterized by limited resources, large-scale random deployment, and a lack of coordination. In this paper, we focus jointly on call admission control and the power allocation problem in HetNet, and we propose a new user association scheme by applying the Voronoi diagram, a powerful computational geometry technique, to solve the user connection problem in which a user has several stations within his range from which to choose. Simulation results show that our proposed scheme can significantly increase the number of admitted users and system throughput, lower the call-blocking ratio, and enhance energy efficiency.

4.2 Introduction

Demand for mobile services is currently exploding, posing major challenges to mobile operators in supporting these high capacity requirements and improving their quality of service. In order to meet throughput demands and uniformly distribute the capacity of a cellular network, the 3rd Generation Partnership Project (3GPP) has introduced Long-Term Evolution-Advanced (LTE-A) networks, which include several new capabilities. One of the most significant new functionalities is Heterogeneous Networks (HetNets) (Damnjanovic et al., 2011), a new design paradigm that provides capacity enhancement and coverage extension for macro cells (MC) by deploying several low power nodes within its coverage. In HetNet, a various small cells are distributed throughout the macro-cell network; these include micro-cells, pico-cells, femtocells, and relay nodes (Damnjanovic et al., 2011). 3GPP uses two backhaul types to connect the radio access network of small cells and the core network: an ideal backhaul link with a high throughput and very low latency used by a dedicated point-to-point connection such as optical fiber or line-of-sight microwave, and a non-ideal backhaul link using an xDSL or non-line-of-sight microwave (Nakamura et al., 2013).

Our research deals with small cells (SCs) for LTE-A radio access enhancement. Due to limited resources, there are certain challenges that need to be addressed in order to enable the coexistence and efficient operation of the high-density random deployment of small cells (ElSawy, Hossain, & Dong In, 2013). Resource management plays a critical role in heterogeneous networks, as it controls channel access and determines how the resources are allocated between users. Therefore, new and more efficient resource management schemes that take into account the characteristics of small cells are crucial to achieving a high Quality of Service (QoS), while simultaneously increasing the entire network's capacity. The resources of interest in this work are bandwidth and power, which may or may not be allocated independently. In this article, we investigate how to maximize the number of admitted users in an overloaded system while minimizing the transmit power given a certain QoS level.

The potential gain in coverage and capacity in heterogeneous networks is highly dependent on the chosen resource management scheme (ElSawy et al., 2013), an issue that has recently drawn increased attention from researchers. Managing resources in such a complex architecture is a major challenge, particularly in a dense small cell environment, thus making the resource allocation problem difficult to tackle. Previous studies have focused on solving this problem in different scenarios, such as distributed or centralized, downlink or uplink, or sparse or dense small cells, by using different constraints, including QoS, power consumption, and resource allocation for the small cell environment. The radio resource allocation among macro- and small cells depends mainly on the network topology (Wang Chi, Quek, & Kountouris, 2012). Therefore, bandwidth and power allocation needs to be performed for macro users, as well as small cell users, in order to achieve the QoS requirements for all users while still maximizing the utilization of the radio spectrum (Chee Wei, 2011). It has been established that only limited performance gains are achieved from the deployment of small cells if resources are not allocated efficiently (Barbieri et al., 2012; Vajapeyam et al., 2011; Yuanye et al., 2012). The three major challenges that need to be addressed in this context are user association, power control, and admission control.

User Association is the process that specifies the user assignment scheme to the different stations available in the system. Usually, the conventional rule in a user association scheme is that a user can only be connected to one station at a time. It has been established that the user-achieved throughput is mainly affected by the decision to associate a user with one station. In the LTE standard (3GPP, 2009), the user association scheme is based solely on the Received Signal Strength (RSS) metric. However, such a scheme is more suitable for homogeneous than heterogeneous networks. In (DOCOMO, 2010a), 3GPP has presented a range expansion scheme to extend the small cell coverage. In (Qualcomm, 2010), a path-loss-based user association has been proposed, in which a user will choose the station that guarantees the minimum path loss. In (Khandekar, Bhushan, Ji, & Vanghi, 2010) and (Tongwei, Dengkun, & Dongkai, 2010), new association schemes that outperform the conventional RSS-based user association scheme have been proposed, but they hold certain assumptions related to resource allocation. In (Khandekar et al., 2010), the authors studied the effect of the user association scheme on the user's throughput while maintaining some resource allocation assumptions. A

joint resource allocation and user association is considered in (Qiaoyang et al., 2013). The total system throughput is considered in (Corroy, Falconetti, & Mathar, 2012), where each user is associated to a station that can maximize the system throughput.

Power Control is the procedure that adjusts the transmit power levels of each station in the system. Traditionally, cellular network base stations use an all-on power control scheme, in which a station is always turned on, even if it is not serving any users. For a heterogeneous network, an on-off power control scheme is proposed in (Ashraf, Boccardi, & Ho, 2011) and (Claussen, Ashraf, & Ho, 2010), where a small cell station is turned on only when it has at least one user to serve; otherwise, it is turned off. This scheme uses less power and therefore achieves higher energy efficiency in comparison to the conventional all-on power control scheme; however, it should be noted that resources are not taken into consideration in this scheme. In (Sung-Rae & Wan, 2013), the authors have shown how power consumption is reduced by minimizing the distance between stations in a heterogeneous network with certain assumptions related to user throughput. A power control scheme based on game theory has been proposed in (Chandrasekhar, Andrews, Muharemovict, Zukang, & Gatherer, 2009), whereas a linear, convex non-cooperative game was studied in (Hkimi, Langar, Secci, Boutaba, & Pujolle, 2013) and (L. Wei, Wei, Tao, & Xiangming, 2013).

Admission Control is the process that regulates the volume of requested calls to a system. Principally, the admission control policy is based on existing traffic load measurements and will involve rejecting new calls only when the load exceeds a predefined threshold. In (Choi, Monajemi, Shinjae, & Villasenor, 2008), a hybrid access strategy was proposed, where a fixed probability was defined based on the signal-to-interference ratio (SIR) for users to be able to connect to femtocells. In (Valcarce, Lopez-Perez, de la Roche, & Jie, 2009), an access control scheme for small cells was presented, in which fixed resources are reserved for macro-cell users' access. In (Ping, Chandrasekhar, & Andrews, 2010), an adaptive access control scheme was proposed based on the macro user density; however, the throughput gain was not significant under a high user-density scenario. In (Siew Eng, Quek, & Debbah, 2012) and (Matskani, Sidiropoulos, Zhi-Quan, & Tassiulas, 2008), a joint admission and power control scheme was proposed based on signal-to-interference-plus-noise ratio (SINR) constraints.

This particular joint optimization problem was also studied in (Mitliagkas, Sidiropoulos, & Swami, 2011) with an outage probability constraint. In (Wang Chi et al., 2012), the author proposed joint resource allocation and access control in order to obtain a high achievable throughput for all femtocell density regimes.

Unlike in previous studies, this paper will jointly address user association, power control, and admission control. Therefore, the objective of this paper is to develop and evaluate a joint user-association-based admission and power control scheme for heterogeneous small cell networks. First, we formulate the problem of user association and propose an integrated framework for heterogeneous small cell networks. Second, we propose a dynamic call admission control policy that considers the small cell load and call-level quality of service, while also helping to keep the system from being overloaded. Finally, we present an adaptive power allocation strategy that considers both user distribution and the density of small cells in heterogeneous networks. The remainder of this paper is organized as follows. Section 3 describes the system model being considered, while Section 4 presents the problem formulation and the proposed scheme. Section 5 presents the proposed algorithm. Our simulation and results are described in Section 6, and a conclusion is presented in Section 7.

4.3 System Model

Our system model is derived from similar models used in Chapter 2. In this work, we consider the downlink transmission of a single macro cell with multiple small cells architecture, as depicted in Figure 4.1. The geographical region is entirely covered by a macro cell, overlaid with several small cells randomly distributed. A minimum distance between two neighboring stations is taken into account to effectively distribute the small cells in targeted areas based on transmission power and area covered. We assume that the macro and the small cells have a maximal transmit power of P_{MC} and P_{SC} respectively where $P_{SC} < P_{MC}$. Different propagation channel models are used for macro and small cells transmissions. Each station (either the macro or a small cells) serves a set of users uniformly distributed in the geographical area.

We assume in our model that we will work in an infinitely backlogged model in which all stations offer Continuous Bit Rate (CBR) applications to their attached users in order to fully utilize the allocated bandwidth.

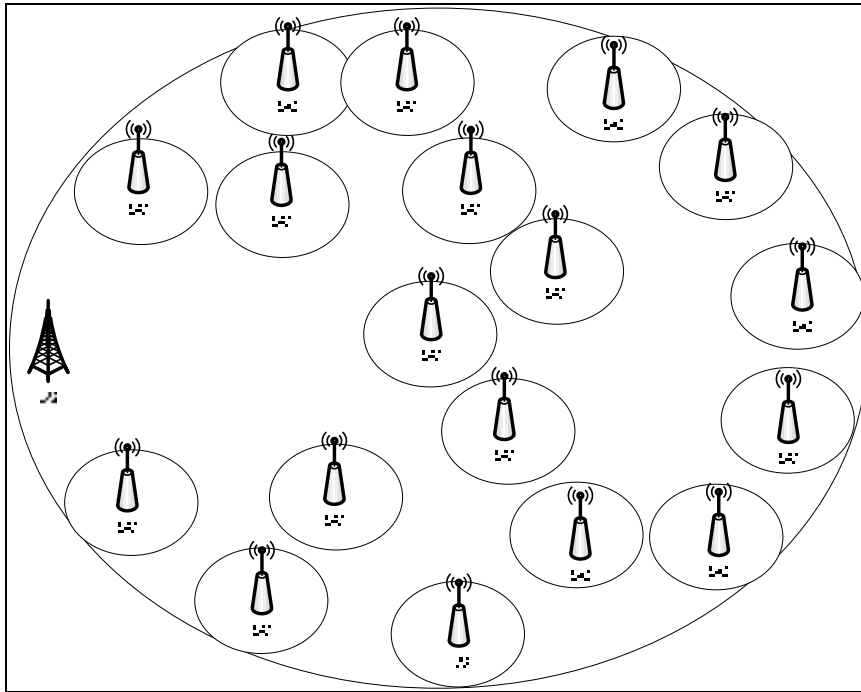


Figure 4.1 Network system model

In this work we focus on the admission and power control mechanism. The total bandwidth of the system is assumed to be divided into orthogonal sub-channels optimally allocated for each station. Unlike our previous work in Chapter 2, in this paper we will consider only the resources at the access link level (the resources of the backhaul links are ignored).

Our proposed joint admission and power control algorithm is performed through an overloaded system with the assumption of a high density of users (up to 500 users) distributed uniformly in a single geographical area who are using a video streaming service, with r_{min} as the minimum required throughput per user. Also, the system is assumed to be static without user mobility and no arrivals of new calls or departures of existing calls.

Assuming that the small cells use an omni-directional antenna and their coverage range is a circle, to minimize interference, neighboring stations will be assigned different channel

groups. To simplify the system model, the interferences between the macro cell and the small cells are ignored.

4.4 Problem Formulation and proposed scheme

This section presents the formulation of the joint admission and power control problem in a heterogeneous network and the proposed user association scheme for such a problem.

4.4.1 Admission Control

Let r_{ij} denote the achievable throughput of user j for an allocated resource $\gamma_{i,j}$ from station i . The achieved throughput is calculated by multiplying the bandwidth assigned by the spectral efficiency, as expressed in the following form:

$$r_{ij} = \gamma_{i,j} A_{i,j} \quad (4.1)$$

where $\gamma_{i,j}$ and $A_{i,j}$ are the bandwidth allocated and achieved spectral efficiency, respectively, in the link between station i and user j .

The total load of attached users within the coverage area of each station i cannot exceed the capacity limitation C_i :

$$\sum_{j \in n_i} \gamma_{i,j} \leq C_i, \quad \forall i \quad (4.2)$$

where n_i is the set of users attached to station i .

We denote the set of variables $\{x_{i,j} | i = 1, 2, \dots, N_s, j = 1, 2, \dots, M\}$ to formulate the user association problem, where $x_{i,j} = 1$ if user j is connected to station i and $x_{i,j} = 0$ otherwise.

$$\sum_{i \in N_s} x_{i,j} = 1, \quad x_{i,j} \in \{0, 1\}, \quad \forall j \quad (4.3)$$

Based on (4.3), the achieved throughput of user j in the system can be given by:

$$r_j = \sum_{i \in N_s} x_{i,j} r_{i,j} \quad (4.4)$$

where the minimum acceptable achieved throughput for a user j to be admitted in the system can be expressed by a QoS limitation constraint as follows:

$$r_j \geq r_{min} \quad (4.5)$$

The objective of our admission control policy is to maximize the number of users admitted in the system. To summarize, the admission control problem in heterogeneous environments can be expressed by the following optimization problem:

$$\begin{aligned} & \max_j \sum_{i,j} x_{i,j} \\ \text{s.t. } & r_j \geq r_{min}, \quad \forall j \\ & \sum_{j \in n_i} \gamma_{i,j} \leq C_i, \quad \forall i \\ & r_j \geq r_{min} \end{aligned} \quad (4.6)$$

4.4.2 Power Control

Let P_i^{max} denote the maximum transmission power level of station i . Hence, the achieved spectral efficiency of user j from station i can be expressed in the following form:

$$A_{i,j} = \log_2(1 + P_{i,j}) \quad (4.7)$$

where $P_{i,j}$ is the received power by user j from station i that can be expressed as:

$$P_{i,j} = \frac{P_i^{max}}{PL_j^i (N_0 + I_j)} \quad (4.8)$$

where PL_j^i is the wireless channel path loss between station i and user j , N_0 is the average noise per subcarrier, and I_j is the interference received by user j from the interfering stations with an assumption that each station is assigned a maximum transmission power P_{SC} .

An outdoor propagation channel model is used for the macro-cell and small cell transmissions. Accordingly, the path loss between station i and user j is given by

$$PL_j^i = 10 \log_{10}(d_{i,j}) + 30 \log_{10}(f_c) + 49 \quad (4.9)$$

where $d_{i,j}$ is the distance between station i and user j , and f_c is the carrier frequency adopted by the station i .

Let P_{thr} stand for the minimum received power level that allows a user j to be connected to the station i . Consequently, we can formulate the following constraint:

$$P_{i,j} \geq P_{thr}, \quad \forall j \in n_i \quad (4.10)$$

Since the goal is to minimize the maximum transmission power, the power control problem in heterogeneous environments can be expressed by the following optimization problem:

$$\begin{aligned} & \min \sum_i P_i^{max} \\ \text{s.t. } & P_{i,j} \geq P_{thr}, \quad \forall j \in n_i \\ & P_i^{max} \leq P_{SC}, \quad \forall i \in N_s \end{aligned} \quad (4.11)$$

4.4.3 Voronoi-based User Association Scheme

To build a tractable analytical model, let us introduce the notion of user attraction to a station. If station resources were unlimited, each user would clearly have to be connected to the nearest station. The analogy of a system of electric charges might be useful here. Let

stations have equal negative charges and users have equal positive charges (we will ignore interactions between users). There exist Coulomb forces between each user and each station. Under typical conditions, each user will be attracted to the nearest station. One way to see which station the user will be attracted to is to calculate the electrostatic potential due to all stations as expressed below:

$$\phi(X, Y) = \sum_i \frac{q_i}{\sqrt{(X - X_i)^2 + (Y - Y_i)^2}} \quad (4.12)$$

where q_i is the charges of station i and X, Y, X_i, Y_i are the user and station i coordinates, respectively. The gradient of this potential will show us in which direction the total force would act on a test charge ('user') located at (X, Y) . Each station now corresponds to a local minimum of the potential. Each user would be within the attraction region of one of the stations.

For our purposes, we need to consider two factors: first, the fact that the resources of the station are in fact limited and described by the variables C_i in (4.2) where the maximum number of users that can be connected to a station is roughly proportional to C_i ; and second, the minimum bandwidth to achieve an acceptable throughput. Using (4.1), the minimum bandwidth to achieve an acceptable throughput can be found by the equation:

$$(Y_{i,j})_{min} = \frac{r_{min}}{A_{i,j}} \quad (4.13)$$

Using equation (4.2), (4.8) results in

$$\sum_j (Y_{i,j})_{min} = r_{min} \sum_j \frac{1}{A_{i,j}} \leq C_i, \quad \forall i \quad (4.14)$$

Let us, for the given station i , calculate and sort in increasing order all $d_{i,j}$, and then find such a user N_i that verify the following conditions:

$$r_{min} \sum_{j=1}^{N_i} \frac{1}{A_{i,j}(d_{i,j})} \leq C_i \quad (4.15)$$

And,

$$r_{min} \sum_{j=1}^{N_i+1} \frac{1}{A_{i,j}(d_{i,j})} > C_i \quad (4.16)$$

Then we can see that the N_i users nearest to station i can be connected to it, which will exhaust the station's resources. Consider the maximum distance $R_i = d_{i,N_i}$ from the station i to a user N_i that can be connected to this station according to conditions (4.15) and (4.16). We will call R_i the radius of attraction of station i . One can see that R_i depends on C_i and on the distribution of users in the vicinity of the station.

Using our simple electrostatic analogy, we can say that a user j will be attracted to a station i if its distance to it $d_{i,j} \leq R_i$. The greater the value of R_i , the more users this station will attract. If we now assign the charge $q_i = R_i$ to the station, then the potential at the distance $d_{i,j}$ from it is

$$\phi_i(d_{i,j}) = \frac{R_i}{d_{i,j}} \quad (4.17)$$

Then the condition that the user is attracted to this station is that $\phi_i(d_{i,j}) \geq 1$. This condition is valid for each station. The station's resources and user distribution in its vicinity are already accounted for in the value R_i . If a user is within the attraction region of more than one station, then it is natural to assume that potential surface will determine the attraction regions of each station. More precisely, the location of the maximum of the potential along the lines connecting every pair or neighboring stations will yield a point through which the boundary of the attraction regions passes. To do so, we will apply the Voronoi diagram, a computational geometry method of implementing a user association algorithm in a two-dimensional area. The Voronoi diagram is applied to solve the problem by dividing the region into several subareas also defined as Voronoi cells. For the user association scheme in a wireless heterogeneous network, the Voronoi diagram is applied with suitable modifications to capture

the resource availability where the metric $R_i/d_{i,j}$ is used instead of the usual metric $d_{i,j}$. Therefore, the optimized Voronoi cell will correspond to the small cell coverage area after the implementation of Voronoi diagram.

Let us define in a two-dimensional Euclidean plane the Voronoi diagram V of N_s station as the subdivision of the region area into N_s Voronoi cells. Based on the potential ϕ_i defined in (4.17), the Voronoi cell v_i of a station i can be expressed as follows:

$$v_i = \{(X, Y) \in \mathbb{R}^2 \mid \forall k \neq i, \phi_i(d_{i,XY}) > \phi_k(d_{k,XY})\} \quad (4.18)$$

where X, Y are the Cartesian coordinates denoting the positions within the Voronoi cell v_i , which means all the users located inside the Voronoi cell v_i are served by the station i .

Then, the whole Voronoi diagram V for all the stations in the region area can be expressed as follows:

$$V = \bigcup_{i=1}^{N_s} v_i \quad (4.19)$$

Then, the solution of the problem (4.6) for calculating the user association $x_{i,j}$ that maximizes the number of users admitted in the system, can be written simply, as below:

$$\max \sum_{i,j} x_{i,j} = \sum_i N_i \quad (4.20)$$

When minimizing the maximum required power of station i , the farthest user within the Voronoi cell v_i should be covered by the small cell located at the site of the Voronoi cell, assuming that the small cell's coverage range is a circle with the station i in its center and R_i as its radius. Combining (4.8) and the objective function in (4.11), we see that the min-max transmission power can be expressed as follows for each station i :

$$(P_i^{max})_{\min} = (N_0 + I_j) P_{thr} PL^i(R_i) \quad (4.21)$$

4.5 Admission and Power Control Algorithm

To maximize the number of users admitted in the system while minimizing the maximum power transmission, a two-stage algorithm was developed to address the joint admission and power control problem in heterogeneous small cell networks under power, QoS, and capacity limitation constraints. In the following algorithm, we use the Voronoi diagram-based user association to solve the optimization problems (4.6) and (4.11) jointly and find a sub-optimal solution using the following stages: *Stage 1*: Admission control policy; *Stage 2*: Adaptive power control scheme. The details of the two stages are presented in the following algorithm.

Algorithm 4.1 User association-based admission and power control algorithm

1. {Initialization}
2. Let X be the matrix of user association with elements $x_{i,j}$
3. Let P^{max} be the array of assigned maximum power
4. {Main Iteration}
5. **for** $i = 1$ to N_s **do**
6. **for** $j = 1$ to M **do**
7. {Stage1}
8. calculate $A_{i,j}, r_{i,j}$
9. **if** $\sum_j \gamma_{i,j} \leq C_i$ **then**
10. connect user j to the station i
11. $x_{i,j} = 1$
12. $x_{k,j} = 0, \forall k \neq i$
13. calculate r_j
14. **end if**
15. **end for**
16. calculate N_i, R_i
17. {Stage2}
18. calculate ϕ_i, v_i
19. $V = V \cup v_i$
20. calculate P_i^{max}
21. **end for**
22. **Return** X, P^{max}
23. **End**

4.6 Simulation And Results

In this section, we conduct a simulation study to evaluate the performance of our proposed solution for the joint problem (4.6) and (4.11). In particular, we start by validating the simulation model and show the results of the Voronoi-based user association for heterogeneous small cell architecture. We then compare the performance of our proposed scheme to another approach. The performance of the proposed algorithm has been evaluated in an urban sparse environment scenario composed of single cell base stations overlaid with 18 small cell stations. As shown in Figure 4.2, each station serves a set of users uniformly distributed in the region.

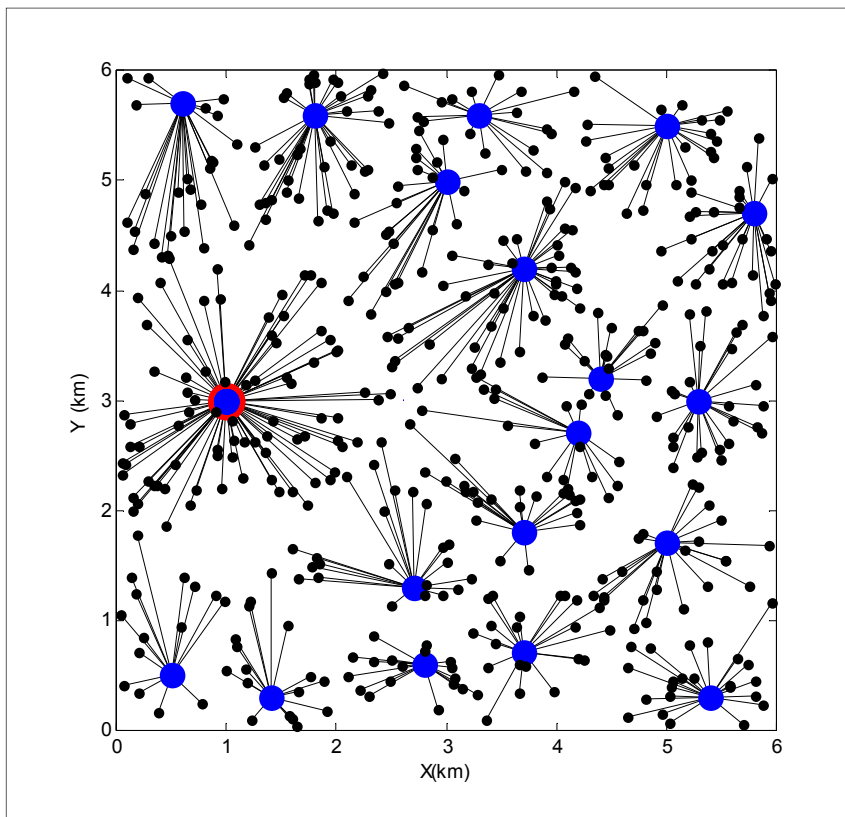


Figure 4.2 Network simulation model

The heterogeneous small cell network simulation parameters are presented in Table 4.1.

Table 4.1 Simulation parameters

Parameter	Value
P_{BS}	43 dBm
P_{SC}	30 dBm
P_{thr}	-100 dBm
r_{min}	1 Mbps
M	500 users
N_s	19 (1 MC+18 SC)
C_i	20 MHz (MC) and 5 MHz (SC)

The simulation results of the total system throughput, the number of users admitted in the system, the blocking probability, and the average maximum transmission power are collected to plot the figures. The following concepts are used to compare and show the performance of our proposed scheme:

Received signal strength: The simplest and most commonly used metric for user association rule, where a user j associates with station i that provides the highest downlink received signal power, i.e., $i^* = \arg \max_{i \in N_s} \{P_{i,j}\}$.

Equal power allocation: We consider each small cell assigned to the fixed maximum transmission power P_{SC} .

We will use JPAC as an abbreviation for the proposed joint admission power control scheme and RSS-EP as an abbreviation for the joint received-signal-strength-equal power allocation scheme. Figures 4.3 to 4.8 show various performance results and emphasize the effectiveness of our proposed solution versus the received-signal-strength-equal power (RSS-EP) scheme.

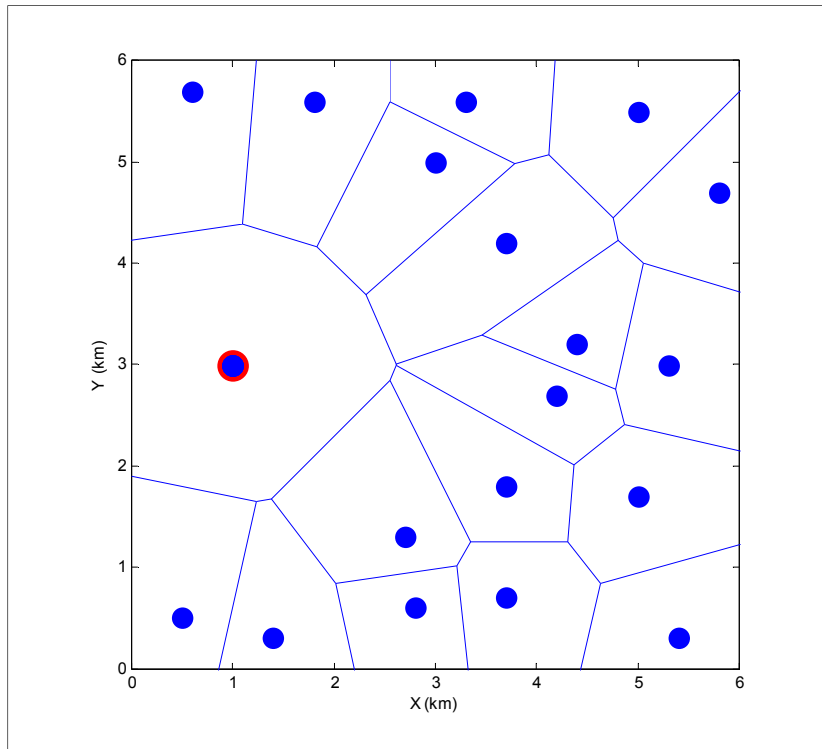


Figure 4.3 Voronoi diagram for a heterogeneous wireless network

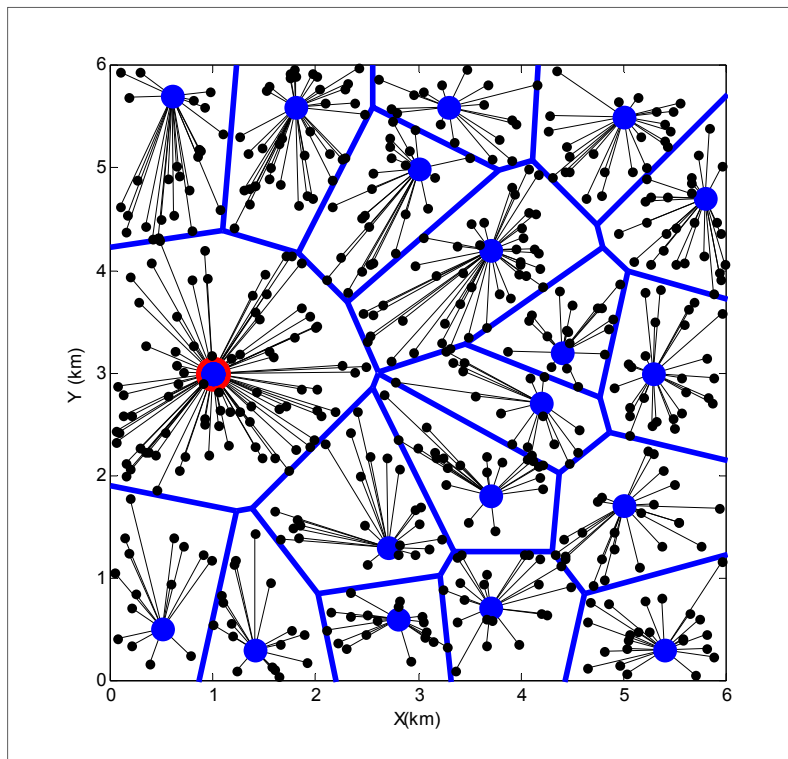


Figure 4.4 User association for a heterogeneous wireless network

Figures 4.3 and 4.4 depict, respectively, the Voronoi diagram and the user association of our proposed algorithm in a heterogenous wireless network. In a general cellular network, users are connected to a base station based on received signal strength. However, our proposed solution uses the Voronoi diagram computation technique with the metric $R_i/d_{i,j}$ instead of the usual metric $d_{i,j}$ to solve the user association problem when a user has several stations in his range from which to choose.

The Voronoi diagram serves to split the plane into a number of polygons, one polygon per station, where any point inside each polygon has the greatest potential ϕ_i to the station of that polygon than to any other one as defined in equation (4.18). The results can be seen in both figures when applying the Voronoi method; the function draws blue lines so that for any pair of neighboring stations (bold blue dots), an edge of a Voronoi diagram passes between them at the point of equal potential. In other word, the points that lie on the edges of the Voronoi diagram are located at exactly the same potential from 2 nearby stations, and the vertices of the Voronoi diagram are located at exactly the same potential from 3 nearby stations. The Voronoi method then computes and connects each user within a certain Voronoi polygon to the station corresponding to that polygon, as illustrated in Figure 4.4.

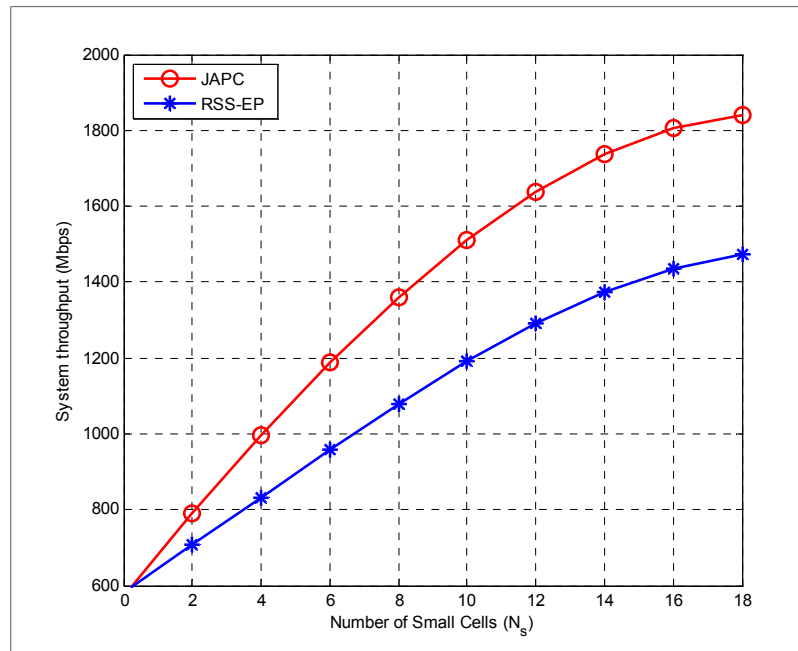


Figure 4.5 System throughput per small cell concentration

Figure 4.5 describes how the total system throughput is affected by the number of small cells in the system. It can be seen that the increment in small cells increases the throughput since it offers more opportunities for the mobile terminal to be handed over to a small cell. The proposed algorithm curve is clearly positioned above those of RSS-EP. Hence, the proposed algorithm can reach higher throughputs under the same network conditions than with RSS-EP. This performance can be explained by equation (4.20) where the variable N_i takes into account resource availability and user location.

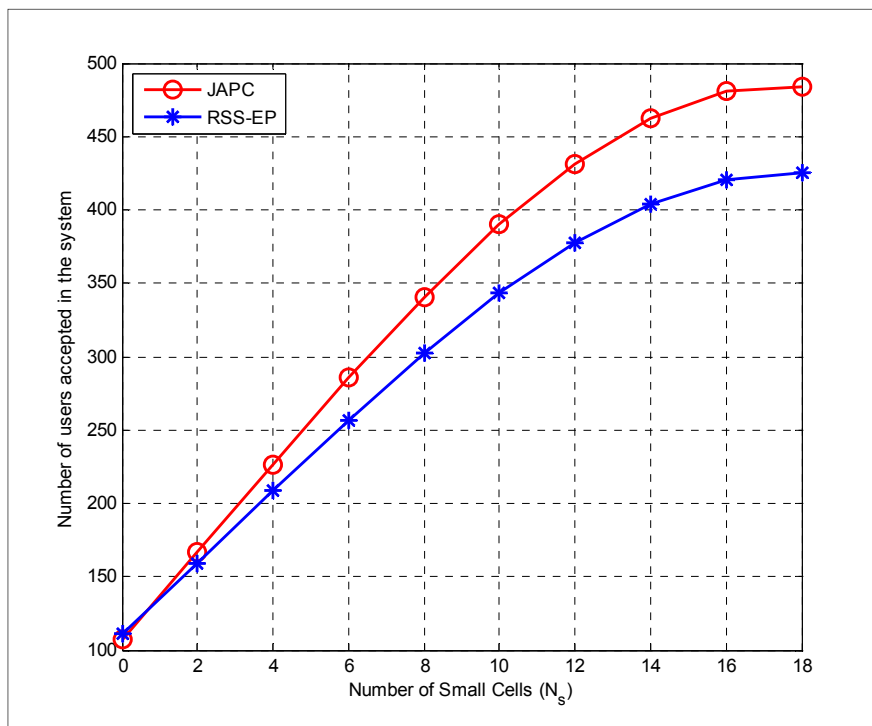


Figure 4.6 Admitted users per small cell concentration

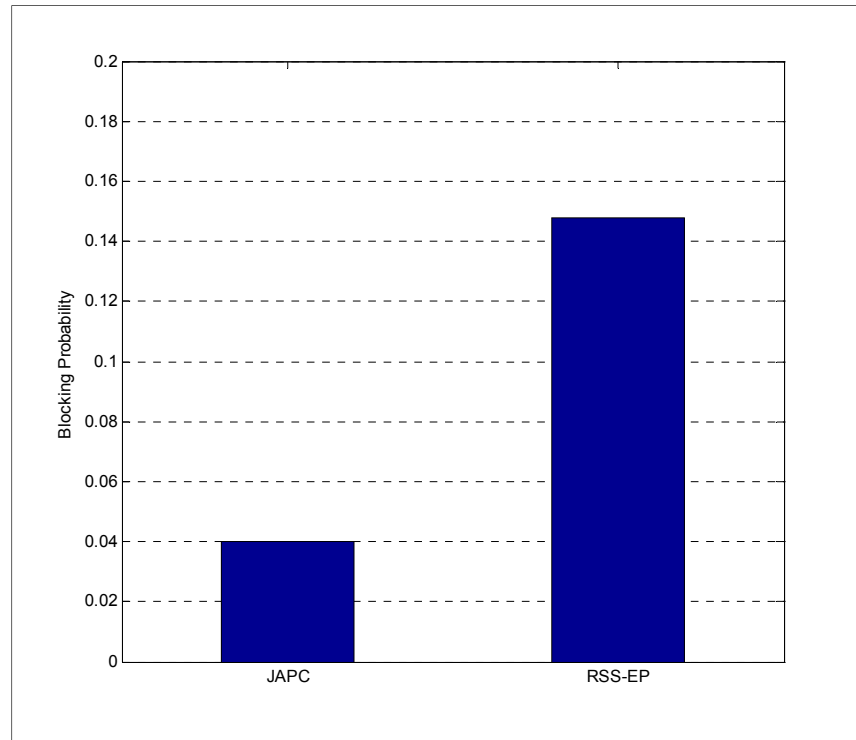


Figure 4.7 Blocking probability per algorithm

Figure 4.6 shows the total number of users in the system under different levels of small cell concentration. From these results, it can be observed that under the proposed algorithm scheme, the number of users admitted by the system increases, therefore increasing the efficiency of the system. This performance can also be explained by the equation (4.20).

Figure 4.7 shows the call blocking performance of the entire system in a scenario in which there are 18 small cells. The call blocking probability is much lower when using our algorithm compared to RSS-EP, since RSS-EP does not take into consideration the available resources in small cells and the user association is mainly based on the received signal strength.

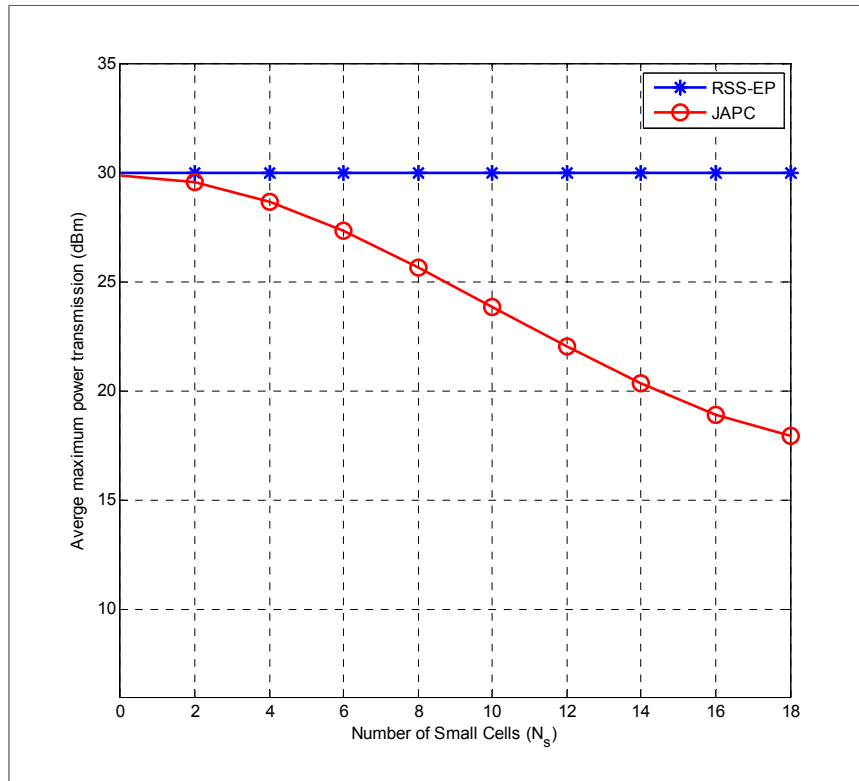


Figure 4.8 Average maximum power transmission per small cell concentration

Figure 4.8 shows that the increment in small cells significantly decreases the average maximum power transmission for our proposed algorithm. The computation results validate the effectiveness of the proposed algorithm since each small cell will adapt the power transmission based on the location of users connected to it. This performance can be explained by the equation (4.21). In a situation with a high concentration of small cells, the Voronoi cells v_i tend to become smaller, and consequently the radius R_i of each small cell's coverage range is reduced to reach just the users concerned while taking in reference the farthest user. It can be seen that in a scenario of 18 small cells, the proposed adaptive power transmission algorithm offers an average gain of 12dB compared to the equal power transmission scheme.

The overall results make it clear that the proposed algorithm offers better performance than the RSS-EP algorithm. This is because it takes into consideration the station's resources and user distribution in its vicinity along with a mechanism to reduce maximum power transmission.

4.7 Conclusion

This paper studies the joint optimization of admission and power control in a downlink heterogeneous small cell network. However, solving such an optimization problem is difficult, especially for large-scale small cell networks. Therefore, a Voronoi-based user association scheme for maximizing the number of admitted users in the system under QoS and capacity limitation constraints was proposed to find near-optimal solutions. In particular, the proposed algorithm maximizes the number of users admitted in the system while minimizing the transmission power and blocking probability by jointly assigning each user to the best stations and optimally allocating the power to each station so that a low transmission power can be assigned.

CONCLUSION

In LTE-A, HetNets have been considered a promising solution to improve spectral bandwidth, efficiency, and mobility support. This work constitutes considerable progress toward that goal. Previously, as presented in Chapter 1, multi-hop relay communication was gaining global acceptance as one of the most promising technologies in next generation wireless cellular networks. However, performing mobility and resource management in such a complex environment is a big challenge as increasing the number of links makes the problem difficult to tackle and not suitable for practical applications. The work of this thesis was proposed to overcome such problems and limitations. To achieve better resource utilization, Chapter 2 describes how nonlinear programming techniques and a heuristic method can be applied. First, the problem formulation of resource allocation and relay selection was presented in order to provide an integrated framework for multi-hop relay networks. Second, in order to provide a dynamic resource allocation scheme, an analytical solution was presented using the Lagrangian and KKT conditions. Finally, an iterative two-stage algorithm was presented to address the joint resource allocation and relay selection problem in multi-hop relay networks under backhaul and capacity limitation constraints. In particular, the first stage proposed a fast approximation analytical solution for the resource allocation algorithm, which takes into account the trade-off between the optimality and the complexity of the multi-hop relay architecture. The second stage presented a heuristic relay selection strategy that considers the RS load and that helps to keep the relay from being overloaded.

In Chapter 3, the relay selection problem was expanded from a MAC layer to a network layer that includes radio path selection among the available relays. Different from the heuristic relay selection strategy presented in Chapter 2, in this part, the relay-selection scheme is based on an MDP that considers the RS load and the existing radio-link path to improve handoff performance. An MDP mathematical model was developed to solve the relay selection problem in a decentralized way and to make the selection process simple. Therefore, the objective was to maintain the throughput and to ensure seamless mobility and

service continuity to all mobile terminals while reducing the handoff frequency and improving handoff performance.

In Chapter 4, the work addressed the problem of joint admission and power control in a general HetNet that consists of several SCs. Compared to the two previous parts of the work, the system was expanded from a multi-hop RS to a general SC context. Therefore, this part focused only on the access link problem, assuming the capacity of the SC backhaul links are large enough not to be bottlenecks. This part of the work mainly addressed the problem of how to maximize the number of admitted users in an overloaded system while minimizing the transmit power given a certain QoS level. A Voronoi-based user association scheme was proposed in order to maximize the number of admitted users in the system under QoS and capacity limitation constraints. This provided a near-optimal solution by using a two-stage algorithm. The first stage proposed a dynamic call admission control policy that considers the SC load and call-level quality of service, while also helping to keep the system from being overloaded. The second stage presented an adaptive power allocation strategy that considers both user distribution and the density of SCs in HetNets.

Achieved Objectives

The main goal behind this work was to solve the following issues:

- how to maximize total user satisfaction in the system;
- how the bandwidth should be shared between different links;
- how to reduce the handoff frequency in multi-hop relay networks;
- how to improve handoff performance in the system;
- how to maximize the number of users admitted into the system; and
- how to reduce the transmission power of SCs.

To that end, the work presented in Chapter 2 provided a new technique for an efficient resource utilization scheme in multi-hop relay networks that enables the operator to attempt a dynamic bandwidth allocation mechanism instead of a static one. This resulted in a dynamic

resource allocation model to maximize user satisfaction while reducing computational complexity.

The work in Chapter 3 provided a novel efficient handoff algorithm based on a new relay-selection strategy to improve handoff performance while ensuring seamless mobility and service continuity to all mobile terminals. Compared to the previous part based on a heuristic method, this chapter provided a different methodology for relay selection. Indeed, this methodology improved handoff performance instead of just maximizing user throughput.

The work in Chapter 4 consisted of a new technique based on a Voronoi diagram to develop a model that motivates SCs to behave cooperatively in a way that serves the whole network interest by maximizing the number of users admitted into the system while reducing power consumption.

Publications

Below is the list of publications delivered from the work related to this thesis:

Journals and Book Chapter

Accepted

Abderrahmane, BenMimoune, & Michel, Kadoch. (2015). Relay Technology for 5G Networks. accepted in the Book Chapter *Internet of Things: Novel Advances and Envisioned Applications*, Springer.

Abderrahmane, BenMimoune, Fawaz A, Khasawneh, Bo, Rong, & Michel, Kadoch. (2015). Dynamic Joint Resource Allocation and Relay Selection for 5G Multi-hop Relay Systems. accepted in *Telecommunication Systems*, Springer.

Abderrahmane, BenMimoune, & Michel, Kadoch. (2015). MDP-based Joint Path Relay Selection in 5G Multi-hop Relay Networks. accepted in *Journal of Network, Academy Publisher*.

Submitted

Abderrahmane, BenMimoune, Fawaz A, Khasawneh, & Michel, Kadoch. (2015). User Association-Based Joint Admission and Power Control for Heterogeneous Wireless Networks. submitted to *Wireless Personal Communication*, Springer.

Conferences

Accepted and Published

Abderrahmane BenMimoune, Fawaz A Khasawneh, Michel Kadoch, & Bo Rong. (6-10 Dec. 2015). *Resource Allocation Framework in 5G Multi-hop Relay System*. Paper presented at the Global Communications Conference (GLOBECOM), 2015 IEEE.

Abderrahmane BenMimoune, Fawaz A Khasawneh, Michel Kadoch, Sun Songlin, & Rong, Bo. (21-26 Sept. 2014). *Inter-cell handoff performance improvement in LTE-a multi-hop relay networks*. Paper presented at the Proceedings of the 12th ACM international symposium on Mobility management and wireless access, Montreal, QC, Canada. 2014 IEEE.

Abderrahmane BenMimoune, Fawaz A. Khasawneh, Michel Kadoch. (24-26 Aug. 2015). *User Association for HetNet Small Cell Networks*. Paper presented at the 3rd International Conference on Future Internet of Things and Cloud, Rome, Italy. 2015 IEEE

Abderrahmane, BenMimoune, & Michel, Kadoch. (2013). *Mobility Management for novel LTE-A Relay System*. Paper presented at the 13th International Conference on Applied Informatics and Communications (AIC '13).

Abderrahmane, BenMimoune., & Michel, Kadoch. (2013). *Multi-Hop Relays for LTE Public Safety Network*. Paper presented at the 13th International Conference on Applied Informatics and Communications (AIC '13).

Future Work

We believe there is more research to be conducted on relaying networks, and the following should be considered:

- Regarding the resource allocation scheme, the work can be extended to address both constant bit-rate services and variable bit-rate services. In addition, a novel scheduling scheme has to be considered to provide QoS satisfaction.
- Multi-backhaul, relay-assisted D2D, mobile relays are attractive mechanisms that can enhance the relaying network performance. However, to support those mechanisms it is crucial to adjust the proposed mobility and resource management schemes.

BIBLIOGRAPHY

- 3GPP. (2009). Technical Specification Group Radio Access Network; Feasibility study for Further Advancements for E-UTRA (Release 9) *TR 36.912 V2.0.0*.
- 3GPP. (2010). Downlink Relay Performance Evaluation. In G. T. R. WG1 (Ed.), *R1-101273*.
- 3GPP. (2012a). Evolved universal terrestrial radio access (E-UTRA): physical layer for relaying operation *TS 36.216*.
- 3GPP. (2012b). Evolved universal terrestrial radio access (E-UTRA): Relay radio transmission and reception *TS 36.116*.
- 3GPP. (2012c). Technical Specification Group Radio Access Network; Mobile Relay for Evolved Universal Terrestrial Radio Access (E-UTRA) *TR 36.836*.
- Abderrahmane, BenMimoune, & Michel, Kadoch. (2015). Relay Technology for 5G Networks. accepted in the Book Chapter *Internet of Things: Novel Advances and Envisioned Applications, Springer*.
- Abderrahmane, BenMimoune, Fawaz A, Khasawneh, Bo, Rong, & Michel, Kadoch. (2015). Dynamic Joint Resource Allocation and Relay Selection for 5G Multi-hop Relay Systems. *Telecommunication Systems, Springer*.
- Abderrahmane, BenMimoune, & Michel, Kadoch. (2015). MDP-based Joint Path Relay Selection in 5G Multi-hop Relay Networks. accepted in *Journal of Networks, Academy Publisher*.
- Abderrahmane, BenMimoune, Fawaz A, Khasawneh, & Michel, Kadoch. (2015). User Association-Based Joint Admission and Power Control for Heterogeneous Wireless Networks. submitted to *Wireless Personal Communication, Springer*.
- Abderrahmane, BenMimoune, Fawaz A, Khasawneh, Michel, Kadoch, & Bo, Rong. (2015, 6-10 Dec. 2015). *Resource Allocation Framework in 5G Multi-hop Relay System*. Paper presented at the Global Communications Conference (GLOBECOM), 2015 IEEE.
- Abderrahmane, BenMimoune, & Michel, Kadoch. (2013). *Mobility Management for novel LTE-A Relay System*. Paper presented at the 13th International Conference on Applied Informatics and Communications (AIC '13).

- Abderrahmane, BenMimoune., & Michel, Kadoch. (2013). *Multi-Hop Relays for LTE Public Safety Network*. Paper presented at the 13th International Conference on Applied Informatics and Communications (AIC '13).
- Abderrahmane, BenMimoune, Fawaz A, Khasawneh, & Michel, Kadoch. (24-26 Aug.2015). *User Association for HetNet Small Cell Networks*. Paper presented at the 3rd International Conference on Future Internet of Things and Cloud, Rome, Italy. 2015 IEEE.
- Akyildiz, Ian F., Gutierrez-Estevez, David M., & Reyes, Elias Chavarria. (2010). The evolution to 4G cellular systems: LTE-Advanced. *Phys. Commun.*, 3(4), 217-244. doi: 10.1016/j.phycom.2010.08.001
- Andrews, M., Lijun, Qian, & Stolyar, A. (2005, 13-17 March 2005). *Optimal utility based multi-user throughput allocation subject to throughput constraints*. Paper presented at the INFOCOM 2005. 24th Annual Joint Conference of the IEEE Computer and Communications Societies. Proceedings IEEE.
- Ann, Sojeong, & Kim, Hyung Seok. (2010). Relay association method for optimal path in IEEE 802.16j mobile multi-hop relay networks. *European Transactions on Telecommunications*, 21(7), 624-631. doi: 10.1002/ett.1419
- Ashraf, I., Boccardi, F., & Ho, L. (2011). SLEEP mode techniques for small cell deployments. *Communications Magazine, IEEE*, 49(8), 72-79. doi: 10.1109/MCOM.2011.5978418
- Aurenhammer, Franz. (1991). Voronoi diagrams - a survey of a fundamental geometric data structure. *ACM Computing Surveys*, 23(3), 345-405. doi: 10.1145/116873.116880
- Barbieri, A., Gaal, P., Geirhofer, S., Ji, T., Malladi, D., Wei, Y., & Xue, F. (2012, 5-10 Feb. 2012). *Coordinated downlink multi-point communications in heterogeneous cellular networks*. Paper presented at the Information Theory and Applications Workshop (ITA), 2012.
- BenMimoune, Abderrahmane, Khasawneh, Fawaz Ali, Kadoch, Michel, Sun, Songlin, & Rong, Bo. (2014). *Inter-cell handoff performance improvement in LTE-a multi-hop relay networks*. Paper presented at the Proceedings of the 12th ACM international symposium on Mobility management and wireless access, Montreal, QC, Canada.
- Bertsekas, Dimitri P. (1999). *Nonlinear Programming* (2nd ed.). Cambridge, MA, USA: Athena Scientific.

- Bhat, P., Nagata, S., Campoy, L., Berberana, I., Derham, T., Guangyi, L., Xiaodong, S., Pingping, Z., Jin, Yang. (2012). LTE-advanced: an operator perspective. *Communications Magazine, IEEE*, 50(2), 104-114. doi: 10.1109/MCOM.2012.6146489
- Bletsas, A., Lippnian, A., & Reed, D. P. (2005, 30 May-1 June 2005). *A simple distributed method for relay selection in cooperative diversity wireless networks, based on reciprocity and channel measurements*. Paper presented at the Vehicular Technology Conference, 2005. VTC 2005-Spring. 2005 IEEE 61st.
- Chandrasekhar, V., Andrews, J. G., Muharemovict, Tarik, Zukang, Shen, & Gatherer, Alan. (2009). Power control in two-tier femtocell networks. *Wireless Communications, IEEE Transactions on*, 8(8), 4316-4328. doi: 10.1109/TWC.2009.081386
- Chang, Liu, Sihai, Zhang, Xiaowei, Qin, & Wuyang, Zhou. (2011, 28-31 March 2011). *Utility-based resource allocation in OFDMA relay networks with service differentiation*. Paper presented at the Wireless Communications and Networking Conference (WCNC), 2011 IEEE.
- Chee Wei, Tan. (2011, 10-15 April 2011). *Optimal power control in Rayleigh-fading heterogeneous networks*. Paper presented at the INFOCOM, 2011 Proceedings IEEE.
- Cheol, Jeong, & Hyung-Myung, Kim. (2008, 15-18 Sept. 2008). *Radio resource allocation in OFDMA multihop cellular cooperative networks*. Paper presented at the Personal, Indoor and Mobile Radio Communications, 2008. PIMRC 2008. IEEE 19th International Symposium on.
- ChiSung, Bae, & Dong-Ho, Cho. (2007). Fairness-Aware Adaptive Resource Allocation Scheme in Multihop OFDMA Systems. *Communications Letters, IEEE*, 11(2), 134-136. doi: 10.1109/LCOMM.2007.061381
- Choi, D., Monajemi, P., Shinjae, Kang, & Villasenor, J. (2008, Nov. 30 2008-Dec. 4 2008). *Dealing with Loud Neighbors: The Benefits and Tradeoffs of Adaptive Femtocell Access*. Paper presented at the Global Telecommunications Conference, 2008. IEEE GLOBECOM 2008. IEEE.
- Claussen, Holger, Ashraf, Imran, & Ho, Lester T. W. (2010). Dynamic idle mode procedures for femtocells. *Bell Labs Technical Journal*, 15(2), 95-116. doi: 10.1002/bltj.20443
- Corroy, S., Falconetti, L., & Mathar, R. (2012, 10-15 June 2012). *Dynamic cell association for downlink sum rate maximization in multi-cell heterogeneous networks*. Paper presented at the Communications (ICC), 2012 IEEE International Conference on.
- Damnjanovic, A., Montojo, J., Yongbin, Wei, Tingfang, Ji, Tao, Luo, Vajapeyam, M., . . . Malladi, D. (2011). A survey on 3GPP heterogeneous networks. *Wireless Communications, IEEE*, 18(3), 10-21. doi: 10.1109/MWC.2011.5876496

- DOCOMO, NTT. (2010a). Performance of eICIC with Control Channel Coverage Limitation. In R1-103264 (Ed.).
- Docomo, NTT. (2010b). Relay Technology in LTE-Advanced. *Technical Journal*, 12(2).
- ElSawy, H., Hossain, E., & Dong In, Kim. (2013). HetNets with cognitive small cells: user offloading and distributed channel access techniques. *Communications Magazine, IEEE*, 51(6), 28-36. doi: 10.1109/MCOM.2013.6525592
- Feinberg, E.A., & Shwartz, A. (2001). *Handbook of Markov Decision Processes: Methods and Applications*: Springer US.
- Girici, Tolga, Chenxi, Zhu, Agre, J., & Ephremides, Anthony. (2008, 1-3 April 2008). *Optimal radio resource management in multihop relay networks*. Paper presented at the Modeling and Optimization in Mobile, Ad Hoc, and Wireless Networks and Workshops, 2008. WiOPT 2008. 6th International Symposium on.
- Hanguan, Shan, Ho Ting, Cheng, & Weihua, Zhuang. (2011). Cross-Layer Cooperative MAC Protocol in Distributed Wireless Networks. *Wireless Communications, IEEE Transactions on*, 10(8), 2603-2615. doi: 10.1109/TWC.2011.060811.101196
- Hasan, M., & Hossain, E. (2013, 9-13 Dec. 2013). *Resource allocation for network-integrated device-to-device communications using smart relays*. Paper presented at the Globecom Workshops (GC Wkshps), 2013 IEEE.
- Hkimi, M., Langar, R., Secci, S., Boutaba, R., & Pujolle, G. (2013, 9-13 June 2013). *Demands rescaling for resource and power allocation in cooperative femtocell networks*. Paper presented at the Communications (ICC), 2013 IEEE International Conference on.
- Ikki, Salama Said, & Ahmed, Mohammed Houssm. (2010). Performance analysis of best-path selection scheme for multi-hop amplify-and-forward relaying. *European Transactions on Telecommunications*, 21(7), 603-610. doi: 10.1002/ett.1411
- Ismail, M., & Weihua, Zhuang. (2012). A Distributed Multi-Service Resource Allocation Algorithm in Heterogeneous Wireless Access Medium. *Selected Areas in Communications, IEEE Journal on*, 30(2), 425-432. doi: 10.1109/JSAC.2012.120222
- Jianwei, Huang, Zhu, Han, Mung, Chiang, & Poor, H. V. (2008). Auction-Based Resource Allocation for Cooperative Communications. *Selected Areas in Communications, IEEE Journal on*, 26(7), 1226-1237. doi: 10.1109/JSAC.2008.080919
- Jünger, Michael, Liebling, Thomas M, Naddef, Denis, Nemhauser, George L, Pulleyblank, William R, Reinelt, Gerhard, . . . Wolsey, Laurence A. (2009). *50 Years of Integer Programming 1958-2008: From the Early Years to the State-of-the-art*: Springer Science & Business Media.

- Kanchei, Loa, Chih-Chiang, Wu, Shiann-Tsong, Sheu, Yifei, Yuan, Chion, M., Huo, D., & Ling, Xu. (2010). IMT-advanced relay standards [WiMAX/LTE Update]. *Communications Magazine, IEEE*, 48(8), 40-48. doi: 10.1109/MCOM.2010.5534586
- Kaneko, M., & Popovski, P. (2007, 24-28 June 2007). *Radio Resource Allocation Algorithm for Relay-Aided Cellular OFDMA System*. Paper presented at the Communications, 2007. ICC '07. IEEE International Conference on.
- Khandekar, A., Bhushan, N., Ji, Tingfang, & Vanghi, V. (2010, 12-15 April 2010). *LTE-Advanced: Heterogeneous networks*. Paper presented at the Wireless Conference (EW), 2010 European.
- Kwak, R., & Cioffi, J. M. (2007, 26-30 Nov. 2007). *Resource-Allocation for OFDMA Multi-Hop Relaying Downlink Systems*. Paper presented at the Global Telecommunications Conference, 2007. GLOBECOM '07. IEEE.
- Lei, Huang, Mengtian, Rong, Lan, Wang, Yisheng, Xue, & Schulz, E. (2007, 22-25 April 2007). *Resource Allocation for OFDMA Based Relay Enhanced Cellular Networks*. Paper presented at the Vehicular Technology Conference, 2007. VTC2007-Spring. IEEE 65th.
- Liebl, G., de Moraes, T. M., Soysal, A., & Seidel, E. (2011, 3-4 May 2011). *Fair resource allocation for inband relaying in LTE-Advanced*. Paper presented at the Multi-Carrier Systems & Solutions (MC-SS), 2011 8th International Workshop on.
- Long, Le, & Hossain, E. (2007). Multihop Cellular Networks: Potential Gains, Research Challenges, and a Resource Allocation Framework. *Communications Magazine, IEEE*, 45(9), 66-73. doi: 10.1109/MCOM.2007.4342859
- Ma, Kai, Liu, Zhixin, & Guan, Xinping. (2012). Joint Relay Selection and Power Allocation for Cooperative Cellular Networks. *Wireless Personal Communications*, 64(2), 305-321. doi: 10.1007/s11277-010-0200-8
- Matskani, E., Sidiropoulos, N. D., Zhi-Quan, Luo, & Tassiulas, L. (2008). Convex approximation techniques for joint multiuser downlink beamforming and admission control. *Wireless Communications, IEEE Transactions on*, 7(7), 2682-2693. doi: 10.1109/TWC.2008.070104
- Mehrjoo, Mehri, Moazeni, Somayeh, & Shen, Xuemin. (2010). Resource allocation in OFDMA networks based on interior point methods. *Wireless Communications and Mobile Computing*, 10(11), 1493-1508. doi: 10.1002/wcm.838
- Mi Kyoung, Kim, & Lee, H. S. (2007, 1-4 July 2007). *Radio Resource Management for a Two-hop OFDMA Relay System in Downlink*. Paper presented at the Computers and Communications, 2007. ISCC 2007. 12th IEEE Symposium on.

- Michalopoulos, D. S., Karagiannidis, G. K., Tsiftsis, T. A., & Mallik, R. K. (2006, Nov. 27 2006-Dec. 1 2006). *WLC41-1: An Optimized User Selection Method for Cooperative Diversity Systems*. Paper presented at the Global Telecommunications Conference, 2006. GLOBECOM '06. IEEE.
- Mitliagkas, I., Sidiropoulos, N. D., & Swami, A. (2011). Joint Power and Admission Control for Ad-Hoc and Cognitive Underlay Networks: Convex Approximation and Distributed Implementation. *Wireless Communications, IEEE Transactions on*, 10(12), 4110-4121. doi: 10.1109/TWC.2011.100811.101381
- Nakamura, T., Nagata, S., Benjebbour, A., Kishiyama, Y., Tang, Hai, Shen, Xiaodong, Yang, Ning, Li, Nan. (2013). Trends in small cell enhancements in LTE advanced. *Communications Magazine, IEEE*, 51(2), 98-105. doi: 10.1109/MCOM.2013.6461192
- Oyman, O. (2010). Opportunistic scheduling and spectrum reuse in relay-based cellular networks. *Wireless Communications, IEEE Transactions on*, 9(3), 1074-1085. doi: 10.1109/TWC.2010.03.081306
- Parkvall, S., Furuskar, A., & Dahlman, E. (2011). Evolution of LTE toward IMT-advanced. *Communications Magazine, IEEE*, 49(2), 84-91. doi: 10.1109/MCOM.2011.5706315
- Ping, Xia, Chandrasekhar, V., & Andrews, J. G. (2010, 6-10 Dec. 2010). *Femtocell Access Control in the TDMA/OFDMA Uplink*. Paper presented at the Global Telecommunications Conference (GLOBECOM 2010), 2010 IEEE.
- Puterman, Martin L. (1994). *Markov Decision Processes: Discrete Stochastic Dynamic Programming*: John Wiley & Sons, Inc.
- Qiaoyang, Ye, Beiyu, Rong, Yudong, Chen, Al-Shalash, M., Caramanis, C., & Andrews, J. G. (2013). User Association for Load Balancing in Heterogeneous Cellular Networks. *Wireless Communications, IEEE Transactions on*, 12(6), 2706-2716. doi: 10.1109/TWC.2013.040413.120676
- Qualcomm. (2010). LTE Advanced: Heterogeneous Networks. In W. Paper (Ed.).
- Roth, S., Jiansong, Gan, & Danev, D. (2010, 26-30 Sept. 2010). *Subframe allocation for relay networks in the LTE advanced standard*. Paper presented at the Personal Indoor and Mobile Radio Communications (PIMRC), 2010 IEEE 21st International Symposium on.
- Sadek, A. K., Zhu, Han, & Liu, K. J. R. (2006, June 2006). *A Distributed Relay-Assignment Algorithm for Cooperative Communications in Wireless Networks*. Paper presented at the Communications, 2006. ICC '06. IEEE International Conference on.

- Saleh, Abdallah Bou, Redana, Simone, Hämäläinen, Jyri, & Raaf, Bernhard. (2010). On the coverage extension and capacity enhancement of inband relay deployments in LTE-advanced networks. *JECE*, 2010, 1-10. doi: 10.1155/2010/894846
- Salem, M., Adinoyi, A., Rahman, M., Yanikomeroglu, H., Falconer, D., Young-Doo, Kim, . . . Yoon-Chae, Cheong. (2010). An Overview of Radio Resource Management in Relay-Enhanced OFDMA-Based Networks. *Communications Surveys & Tutorials, IEEE*, 12(3), 422-438. doi: 10.1109/SURV.2010.032210.00071
- Salem, M., Adinoyi, A., Rahman, M., Yanikomeroglu, H., Falconer, D., Young-Doo, Kim, . . . Eungsun, Kim. (2009, 14-18 June 2009). *Fairness-Aware Joint Routing and Scheduling in OFDMA-Based Cellular Fixed Relay Networks*. Paper presented at the Communications, 2009. ICC '09. IEEE International Conference on.
- Salem, M., Adinoyi, A., Yanikomeroglu, H., & Falconer, D. (2010). Opportunities and Challenges in OFDMA-Based Cellular Relay Networks: A Radio Resource Management Perspective. *Vehicular Technology, IEEE Transactions on*, 59(5), 2496-2510. doi: 10.1109/TVT.2010.2042736
- Schoenen, R., Halfmann, R., & Walke, Bernhard H. (2008, 11-14 May 2008). *An FDD Multihop Cellular Network for 3GPP-LTE*. Paper presented at the Vehicular Technology Conference, 2008. VTC Spring 2008. IEEE.
- Schoenen, R., Zirwas, W., & Walke, Bernhard H. (2008, 19-23 May 2008). *Capacity and Coverage Analysis of a 3GPP-LTE Multihop Deployment Scenario*. Paper presented at the Communications Workshops, 2008. ICC Workshops '08. IEEE International Conference on.
- Shanzhi, Chen, & Jian, Zhao. (2014). The requirements, challenges, and technologies for 5G of terrestrial mobile telecommunication. *Communications Magazine, IEEE*, 52(5), 36-43. doi: 10.1109/MCOM.2014.6815891
- Siew Eng, Nai, Quek, T. Q. S., & Debbah, M. (2012, 24-27 Sept. 2012). *Shadowing time-scale admission and power control for small cell networks*. Paper presented at the Wireless Personal Multimedia Communications (WPMC), 2012 15th International Symposium on.
- Spectrum, Radio Access and. (2014). 5G Radio Network Architecture *The 7th Framework Programme in the area of Future Networks*.
- Sung-Rae, Cho, & Wan, Choi. (2013). Energy-Efficient Repulsive Cell Activation for Heterogeneous Cellular Networks. *Selected Areas in Communications, IEEE Journal on*, 31(5), 870-882. doi: 10.1109/JSAC.2013.130506

- Teyeb, Oumer, Van Phan, Vinh, Raaf, Bernhard, & Redana, Simone. (2009). Dynamic Relaying in 3GPP LTE-Advanced Networks. *EURASIP Journal on Wireless Communications and Networking*, 2009(1), 731317.
- Tongwei, Qu, Dengkun, Xiao, & Dongkai, Yang. (2010, 26-28 Oct. 2010). *A novel cell selection method in heterogeneous LTE-advanced systems*. Paper presented at the Broadband Network and Multimedia Technology (IC-BNMT), 2010 3rd IEEE International Conference on.
- Vajapeyam, M., Damnjanovic, A., Montojo, J., Tingfang, Ji, Yongbin, Wei, & Malladi, D. (2011, 5-9 June 2011). *Downlink FTP Performance of Heterogeneous Networks for LTE-Advanced*. Paper presented at the Communications Workshops (ICC), 2011 IEEE International Conference on.
- Valcarce, A., Lopez-Perez, D., de la Roche, G., & Jie, Zhang. (2009, 13-16 Sept. 2009). *Limited access to OFDMA femtocells*. Paper presented at the Personal, Indoor and Mobile Radio Communications, 2009 IEEE 20th International Symposium on.
- Venkataraman, H., Sinanovic, S., & Haas, H. (2008). Cluster-Based Design for Two-hop Cellular Networks. *International Journal of Communications, Network and System Sciences*, 1(4), 370-385.
- Vyalyi, Mikhail Nikolaevich, Gordeyev, EN, & Tarasov, Sergei Pavlovich. (1996). The stability of the Voronoi diagram. *Computational mathematics and mathematical physics*, 36(3), 405-414.
- Wang Chi, Cheung, Quek, T. Q. S., & Kountouris, M. (2012). Throughput Optimization, Spectrum Allocation, and Access Control in Two-Tier Femtocell Networks. *Selected Areas in Communications, IEEE Journal on*, 30(3), 561-574. doi: 10.1109/JSAC.2012.120406
- Wei, H.Y., Rykowski, J., & Dixit, S. (2013). *WiFi, WiMAX and LTE Multi-hop Mesh Networks: Basic Communication Protocols and Application Areas*: Wiley.
- Wei, Li, Wei, Zheng, Tao, Su, & Xiangming, Wen. (2013, 7-10 April 2013). *Distributed power control and pricing for two-tier OFMDA femtocell networks using fictitious game*. Paper presented at the Wireless Communications and Networking Conference (WCNC), 2013 IEEE.
- Weihua, Zhuang, & Ismail, M. (2012). Cooperation in wireless communication networks. *Wireless Communications, IEEE*, 19(2), 10-20. doi: 10.1109/MWC.2012.6189408
- Wooseok, Nam, Woohyuk, Chang, Sae-Young, Chung, & Lee, Y. H. (2007, 24-28 June 2007). *Transmit Optimization for Relay-Based Cellular OFDMA Systems*. Paper presented at the Communications, 2007. ICC '07. IEEE International Conference on.

- Yang, Yang, Honglin, Hu, Jing, Xu, & Guoqiang, Mao. (2009). Relay technologies for WiMax and LTE-advanced mobile systems. *Communications Magazine, IEEE*, 47(10), 100-105. doi: 10.1109/MCOM.2009.5273815
- Yi, Zhao, Adve, R., & Teng Joon, Lim. (2007). Improving amplify-and-forward relay networks: optimal power allocation versus selection. *Wireless Communications, IEEE Transactions on*, 6(8), 3114-3123. doi: 10.1109/TWC.2007.06026
- Yindi, Jing, & Jafarkhani, Hamid. (2009). Single and multiple relay selection schemes and their achievable diversity orders. *Wireless Communications, IEEE Transactions on*, 8(3), 1414-1423. doi: 10.1109/TWC.2008.080109
- Ying-Dar, Lin, & Yu-Ching, Hsu. (2000, 26-30 Mar 2000). *Multihop cellular: a new architecture for wireless communications*. Paper presented at the INFOCOM 2000. Nineteenth Annual Joint Conference of the IEEE Computer and Communications Societies. Proceedings. IEEE.
- Yuanye, Wang, Soret, B., & Pedersen, K. I. (2012, 10-15 June 2012). *Sensitivity study of optimal eICIC configurations in different heterogeneous network scenarios*. Paper presented at the Communications (ICC), 2012 IEEE International Conference on.
- Yutao, Sui, Vihriala, J., Papadogiannis, A., Sternad, M., Wei, Yang, & Svensson, T. (2013). Moving cells: a promising solution to boost performance for vehicular users. *Communications Magazine, IEEE*, 51(6), 62-68. doi: 10.1109/MCOM.2013.6525596