

ÉCOLE DE TECHNOLOGIE SUPÉRIEURE
UNIVERSITÉ DU QUÉBEC

THESIS PRESENTED TO
ÉCOLE DE TECHNOLOGIE SUPÉRIEURE

IN PARTIAL FULFILMENT OF THE REQUIREMENTS
FOR THE DEGREE OF
DOCTOR OF PHILOSOPHY
Ph.D.

BY
Amin CHAABANE

MULTI-CRITERIA METHODS FOR DESIGNING AND EVALUATING
SUSTAINABLE SUPPLY CHAINS

MONTREAL, FEBRUARY 4 2011

© Copyright 2011 reserved by Amin Chaabane

© Copyright reserved

It is forbidden to reproduce, save or share the content of this document either in whole or in parts. The reader who wishes to print or save this document on any media must first get the permission of the author.

BOARD OF EXAMINERS (THESIS PH.D)

THIS THESIS HAS BEEN EVALUATED

BY THE FOLLOWING BOARD OF EXAMINERS

M. Amar Ramudhin, Thesis Supervisor
Département de génie de la production automatisée à l'École de technologie supérieure

M. Marc Paquet, Thesis Co-supervisor
Département de génie de la production automatisée à l'École de technologie supérieure

M. Jean-Pierre Kenné, President of the Board of Examiners
Département de génie mécanique à l'École de technologie supérieure

M. Ali Gharbi, Member of the Board of Examiners
Département de génie de la production automatisée à l'École de technologie supérieure

Mme. Sophie d'Amours, External Member of the Board of Examiners
Département de génie mécanique à l'Université Laval

THIS THESIS WAS PRESENTED AND DEFENDED

BEFORE A BOARD OF EXAMINERS AND PUBLIC

SEPTEMBER 9, 2010

AT ÉCOLE DE TECHNOLOGIE SUPÉRIEURE

ACKNOWLEDGMENTS

The work presented in this thesis was performed at the Laboratoire de Recherche sur les Chaînes d'approvisionnement (LRCA) in the Department of Automated Production Engineering at the École de technologie supérieure (ETS).

This thesis would have been impossible without the unstinting guidance, motivation, and help provided by my advisors and dissertation committee Prof. Amar Ramudhin and Marc Paquet. I am also grateful to my dissertation committee members Prof. Sophie D'Amours, Ali Gharbi, and Jean-Pierre Kenné for their valuable comments that have honed and enriched my work.

Words cannot say how indebted I am to my father Khalifa and mother Mounira for taking an unbelievable amount of interest in PhD studies and providing me with the love, energy, and support that has seen my PhD culminate successfully.

I am indeed grateful to my fiancée Ghofrane, my brother Walid, my sisters Lobna and Hanen for being so unselfishly caring and loving, and for often putting up with my scarcity during the course of my PhD studies. A very special thanks to my aunt Henda and her husband Rezk for their continuous support during the different phases of the program.

Lastly, I am thankful to all my friends and colleagues at LRCA and ETS, who gave me their support in a work environment full of peace and good humour.

MULTI-CRITERIA METHODS FOR DESIGNING AND EVALUATING SUSTAINABLE SUPPLY CHAINS

Amin CHAABANE

ABSTRACT

Sustainable supply chain management covers interactions between the economic dimension, the environment, and society. My dissertation, titled multi-criteria methods for designing and evaluating sustainable supply chains, studies supply chain decisions-making and trade-offs at the interface between supply chain' operations and the environment. My dissertation comprises four research papers that develop novel approaches that enhance the literature of supply chain management.

The first article, titled "*A two-phase multi-criteria decision support system for supply chain management* ", focused on the economic dimension, considered for a long time as the only performance that guarantee supply chain design and planning efficiencies. The proposed approach introduces a two-phase hierarchical approach to solve a multi-criteria SCM problem integrating both strategic and tactical decisions. The first phase evaluates different potential configurations of supply chains using Analytic Hierarchy Process (AHP). The second phase solves the network for the optimal safety stock placement using dynamic programming.

Although the environmental and social criteria are not considered, they can be added at the first phase as additional criteria to ensure the selection of sustainable supply chain. However, it is better to include these criteria at the design phase to consider the most important strategic decisions that influence the economic, environmental and social performance of the supply chain.

Thus, the second article, titled "*Designing and evaluating sustainable supply chains*", introduces a multi-objective linear programming model for sustainable supply chain design that takes into account the economic and the environmental objectives at the design time. This article addresses the design of supply chains that are also sensitive to the carbon market. The proposed methodology provides decision makers with the ability to evaluate the trade-offs between total logistics costs and carbon offsetting under different supply chain operating strategies, environmental regulatory constraints and carbon market price evolution. Validation using an illustrative example derived from the steel industry, where legislation imposes caps on greenhouse gases emissions, shows the advantages of such novel approach. This paper shows also that under the dynamic of the carbon market place, it is important to consider a multi-period model for the strategic planning of sustainable supply chains.

The third article, titled “*Design of sustainable supply chain under the emission trading scheme*”, focus on the long-term, strategic planning of sustainable and closed-loop supply chains. The design task is formulated as a multi-objective optimization linear program that accounts for the minimization of total logistics costs (economic performance) and greenhouse gases (GHG) emissions (environmental impact). From an economic perspective, the link with “Environmental Economics Solutions” is made through the Emission Trading Scheme. On the other hand, the environmental performance evaluation is based on the Life Cycle Assessment (LCA) methodology that quantifies the burdens and impact along the life cycle stages. Thus, the material and energy balances are considered in the supply chain network design problem as well as many critical outputs. Capabilities of the proposed model are illustrated through a numerical study.

Keyword : Supply chain design, sustainable supply chain, environment, recycling, carbon market, mixed integer programming, multi-criteria decision making, multi-objective optimization.

MÉTHODES DE CONCEPTION ET D'ÉVALUATION MULTICRITÈRES DES CHAÎNES D'APPROVISIONNEMENT DURABLES

Amin CHAABANE

RÉSUMÉ

La gestion des chaînes d'approvisionnement durables étudie l'interaction entre les trois dimensions économique, environnementale et sociale. La thèse de doctorat a porté sur le développement de nouvelles méthodes d'aide à la décision pour la conception et l'évaluation multicritères des chaînes d'approvisionnement durables. Cette thèse a permis de contribuer à l'avancement de la recherche par 4 articles de revue avec comité de lectures (publiés, acceptés et soumis).

Le premier article de cette thèse (i.e., chapitre 2) se focalise sur la dimension économique. On a cherché à apporter une contribution à la gestion de la chaîne d'approvisionnement qui considère plus qu'un objectif pour assurer la durabilité économique. Une approche hiérarchique à deux phases incluant les niveaux de décision stratégique et tactique est introduite. L'évaluation qualitative de la chaîne est faite selon le modèle de référence «Supply Chain Operations Reference» (SCOR). Dans la première phase, l'évaluation de plusieurs configurations de chaînes potentielles est réalisée et le choix est obtenu avec la méthode d'analyse selon le processus hiérarchique (AHP). La deuxième phase résout le problème de positionnement de stocks de sécurité dans le réseau.

Les dimensions environnementales et sociales n'ont pas été intégrées, mais celles-ci sont de plus en plus important à considérer pour la gestion des chaînes d'approvisionnement durables et pourraient être prises en compte par exemple au niveau de l'analyse AHP en ajoutant d'autres critères de performance qui enrichissent le modèle SCOR. Cependant, l'intégration de ces aspects au niveau de la génération des configurations de chaînes pourrait anticiper à l'avance certains choix stratégiques les plus influents sur la performance économique, environnementale et sociale de la chaîne d'approvisionnement.

De ce fait, dans le deuxième article (i.e., chapitre 3), on propose un modèle mathématique de programmation linéaire avec une seule période pour la conception des chaînes d'approvisionnement qui prend en compte en plus des considérations économiques et environnementales, l'interaction avec le marché de carbone, un des mécanismes que plusieurs pays utilisent pour atteindre les objectifs de développement durable. L'objectif est de voir l'impact d'une telle interaction sur la configuration de la chaîne et pouvoir évaluer la meilleure stratégie à suivre pour respecter les réglementations en vigueur. Cet article a montré aussi que face à la dynamique du marché du carbone, l'utilisation d'un modèle multi-

période est primordiale pour la planification stratégique des chaînes d’approvisionnement durables.

Le troisième article (i.e., chapitre 4) se consacre au développement d’un modèle mathématique générique multi-période pour la planification des chaînes d’approvisionnement durables. Il se base sur la méthode de l’analyse de cycle de vie pour supporter les décisions au niveau de l’opération de la chaîne d’approvisionnement dans un environnement qui impose à la fois des objectifs en termes de réduction de gazes à effet de serre et des réglementations sur la gestion de retour des produits à la fin de leur cycle de vie.

Mots clés : conception des chaînes d’approvisionnement, chaîne d’approvisionnement durable, environnement, recyclage, marché de carbone, programmation en nombre entiers, analyse multicritères, optimisation multi-objective.

TABLE OF CONTENTS

	Page
INTRODUCTION	1
CHAPTER 1 LITERATURE REVIEW	17
1.1 Introduction.....	17
1.1.1 Past supply chain management models.....	18
1.1.2 Literature review plan and methodology	22
1.2 Decision models for sustainable supply chain management.....	24
1.2.1 Sustainable supply chains processes.....	25
1.2.2 Decisions scope.....	27
1.2.3 Performance measure.....	36
1.2.4 Solution procedure	36
1.2.5 Applications in industry.....	37
1.3 Discussion.....	37
1.4 Toward an integrated approach for SSCM	39
1.5 Conclusion	41
CHAPTER 2 ARTICLE #1 «A TWO-PHASE MULTI-CRITERIA DECISION SUPPORT SYSTEM FOR SUPPLY CHAIN MANAGEMENT».....	42
2.1 Introduction.....	43
2.2 Literature review.....	45
2.3 Problem statement and proposed approach.....	47
2.3.1 Problem statement.....	47
2.3.2 The proposed approach.....	48
2.4 Supply chain network selection phase using AHP	49
2.4.1 The Analytic Hierarchy Process (AHP).....	49
2.4.2 SCOR Level 1 metrics	51
2.4.3 Supply chain selection based on AHP	52
2.5 Safety stock optimization phase.....	57
2.5.1 Basic assumptions and notations	57
2.5.2 Model formulation : safety stock cost optimization	60
2.5.3 Dynamic programming formulation	61
2.5.4 A numerical example	62
2.6 Conclusion and future research.....	64
2.7 References.....	65
2.8 Appendix SCOR level 1 metrics (Supply Chain Council, 2006).....	69

CHAPTER 3	ARTICLE #2 «DESIGNING AND EVALUATING SUSTAINABLE SUPPLY CHAINS»	70
3.1	Introduction.....	71
3.2	Problem description and literature review	73
3.3	Solution methodology	76
3.4	Mathematical model.....	78
3.5	Solution methods	81
3.6	Optimization methodology for sustainable supply chain design	84
3.7	Experimental evaluation	85
3.8	Conclusion	91
3.9	Appendix : mathematical model	92
	3.9.1 Sets and indices.....	92
	3.9.2 Parameters.....	93
	3.9.3 Decision variables.....	95
	3.9.4 Objective functions	95
	3.9.5 Constraints	97
3.10	References.....	101
CHAPTER 4	ARTICLE #3 «DESIGN OF SUSTAINABLE SUPPLY CHAINS UNDER THE EMISSION TRADING SCHEME».....	104
4.1	Introduction.....	105
4.2	Literature review	106
4.3	Problem statement and methodology	108
4.4	Model development	110
	4.4.1 Assumptions.....	111
	4.4.2 Decision variables.....	113
4.5	Model formulation	116
	4.5.1 Monetary parameters	116
	4.5.2 Technical parameters	118
	4.5.3 Carbon management parameters.....	120
	4.5.4 Economic objective (F_1)	120
	4.5.5 Environmental objective (F_2).....	124
	4.5.6 Constraints	125
4.6	Experimental evaluation	129
	4.6.1 Data.....	129
	4.6.2 Solution method.....	132
	4.6.3 Research questions.....	132
	4.6.4 Results and discussion	133
4.7	Conclusion	137
4.8	References.....	137
CONCLUSION	140
APPENDIX I	TRADE-OFF MODEL FOR CARBON MARKET SENSITIVE SUSTAINABLE SUPPLY CHAIN NETWORK DESIGN	144

BIBLIOGRAPHY176

LIST OF TABLES

	Page
Table 2.1	Pair-wise comparison scale for AHP preferences (Saaty, 2001)50
Table 2.2	Random consistency (RI) (Saaty, 2001)51
Table 2.3	Potential supply chain networks performances.....53
Table 2.4	From pair-wise comparison to AHP scale.....54
Table 2.5	Weights and supply chain networks ranked with AHP : Agile strategy55
Table 2.6	Criteria weights and supply chain networks ranked with AHP56
Table 2.7	Safety level and safety factor60
Table 2.8	Safety stock cost for different service level policies.....63
Table 3.1	Transportation modes and emissions factors (grams/ton-mile)86
Table 3.2	Marginal abatement cost without carbon market integration.....87
Table 3.3	Marginal abatement cost with carbon market integration87
Table 3.4	Goal programming solution91
Table 3.5	Cost structure of the objective function F_196
Table 4.1	Goal Statistics for the model130
Table 4.2	Characteristics of the MIP model.....132
Table 4.3	Comparison of the two scenarios134
Table 4.4	Cost for the different scenarios (Return rate variation).....135

LIST OF FIGURES

	Page
Figure 01	Sustainability : the triple bottom line.2
Figure 02	Supply chain representation.3
Figure 03	SCOR model - Level 1.4
Figure 04	Logistics activities.5
Figure 05	Structure of the supply chain in this study.11
Figure 06	Thesis objectives13
Figure 07	Proposed methodology.15
Figure 1.1	Taxonomy of SSCM planning models.23
Figure 1.2	A strategic framework for sustainable supply chains.26
Figure 1.3	Closed-loop supply chain.32
Figure 1.4	An LCA approach to support the planning of sustainable supply chains.40
Figure 2.1	Supply chain structure in the aeronautic industry.44
Figure 2.2	Decision support system for multi-criteria supply chain analysis.49
Figure 2.3	Hierarchy for measuring supply chain network performance.53
Figure 2.4	Replenishment lead time characterization.59
Figure 2.5	Assembly supply chain.62
Figure 2.6	Safety stock cost for different service level policies.64
Figure 3.1	Sustainable supply chain design methodology.77
Figure 3.2	Supply chain network structure.79
Figure 3.3	Optimization methodology for sustainable supply chain design.85

Figure 3.4	Cost analysis of extreme solutions (scenario 1 versus scenario 2).	88
Figure 3.5	Logistic costs versus carbon emissions.	89
Figure 3.6	Average abatement cost versus carbon emissions reduction.	90
Figure 3.7	Emissions cost / profit component.	90
Figure 4.1	An LCA approach to support sustainable supply chain design.	110
Figure 4.2	Closed-loop supply chain network structure.	112
Figure 4.3	Characteristics of a production unit.	112
Figure 4.4	Characteristics of a production unit.	113
Figure 4.5	Case study supply chain network.	131
Figure 4.6	Carbon prices variation for scenario 2.	133
Figure 4.7	Cost distribution for scenario 2.	134
Figure 4.8	Recycled product under policy stringency.	136
Figure 4.9	Carbon management under policy stringency.	136

ABREVIATIONS

ACV	Analyse de Cycle de Vie
AHP	Analytic Hierarchy Process
APS	Advanced Planning System
BOM	Bill of Material
DSS	Decision Support System
DEA	Data Envelopment Analysis
CSR	Corporate Social Responsibility
EPSC	Electronics Product Stewardship Canada
EPA	Environmental Protection Agency
ELV	End of Life Vehicle
ETS	Emission Trading Scheme
GES	Gaz à effet de serre
GHG	Greenhouse gases
LCA	Life Cycle Assessment
LCM	Life cycle management
MCeX	Montreal Climate Exchange in Canada
MADM	Multi-Attribute Decision Making
MODM	Multi-Objective Decision Making
MOO	Multi-Objective Optimisation
MOC	Mise en œuvre conjointe

MDP	Mécanismes de développement propre
PLM	Product life cycle management
RL	Reverse Logistic
SCM	Supply Chain Management
SSCM	Sustainable Supply Chain Management
SCOR	Supply Chain Operations Reference
WEEE	Waste Electronic and Electrical Equipment

INTRODUCTION

The field of supply chain management has received an increased interest in recent years both in academia and industrial sectors. This is due not only to trade globalization through the outsourcing of logistics activities, but also to the increased competition that requires a global presence. Today, every enterprise operates in a supply chain which is much more complex than it was before. Also, increased demand for fast and reliable deliveries has imposed new challenges for companies and pushed managers to improve the management of supply chains (Mentzer, 2001).

In the same vein, emerging issues such as rising energy prices, the limits of available resources (not renewable), climate change, objectives in terms of reducing emissions (liquid, solid, and gaseous), and concerns for improving the quality of life have attracted the attention of managers to develop a strategy based on corporate social responsibility and migrate towards the era of sustainable supply chains (Carter, 2008; Nagurney et al., 2007; Paul R. Kleindorfer et al., 2005). The integration of sustainability practices in supply chain management is relatively new, but growing continuously (Seuring et al., 2008).

This new trend requires a shift in paradigms by focusing on the three pillars of sustainable development (Figure 01): economic prosperity, ecology (environment protection) and the social dimension (Elkington, 1998).

The goal of sustainable development is to find a coherent balance (compromise solution) between these three objectives. Several actions and decisions at different levels can contribute and can be divided into three categories:

1. Agreement between nations negotiated at the global level of the planet, for example the Kyoto Protocol;
2. Policies by economic area (European Union, North America, Latin America, Asia, etc.);
3. Corporate strategies at the enterprise level (for example, sustainable production and design).

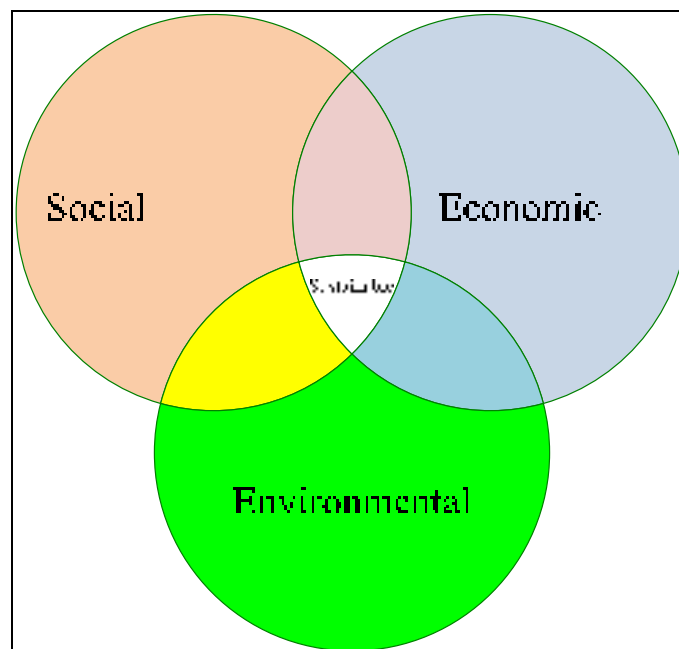

Figure 01 Sustainability: the triple bottom line.
Adapted from Carter (2008)

This research belongs rather to the third category, and focuses on companies operating in complex supply chain, and need to rethink their current supply chain management practices to achieve sustainability objectives in a voluntary manner or under environmental regulations and laws.

Through the various contributions presented in the document, this research will try to bring solutions to the problems of modeling and managing supply chains for future practices in the management of sustainable enterprises. Also, this work must define guidance in the development of new generations of advanced planning systems. More specifically, decision making models based on mathematical programming are presented to assist managers to find the best decisions while respecting sustainability objectives.

Background

The issue of supply chains is present in the entire company. This concept itself rise to somewhat to different interpretations (Cooper, 1997). In this section, our goal is not to propose a state of the art in the field of supply chain management, several authors propose a detailed review (Croom et al. (2000), Karpak et al. (2001) et Burgess (2006)), but rather to expose the evolution of supply chain management practices.

Lee and Billington (1993) proposed an operational view of the supply chain and considered that is “a network of facilities that performs functions related to the supply of raw materials, transformation of these raw materials into components then to finished products, and distribution of finished products to the client”. Figure 02 shows the function of supply (relationship between supplier and producer), processing (production of goods) and distribution (transportation of final products to clients).

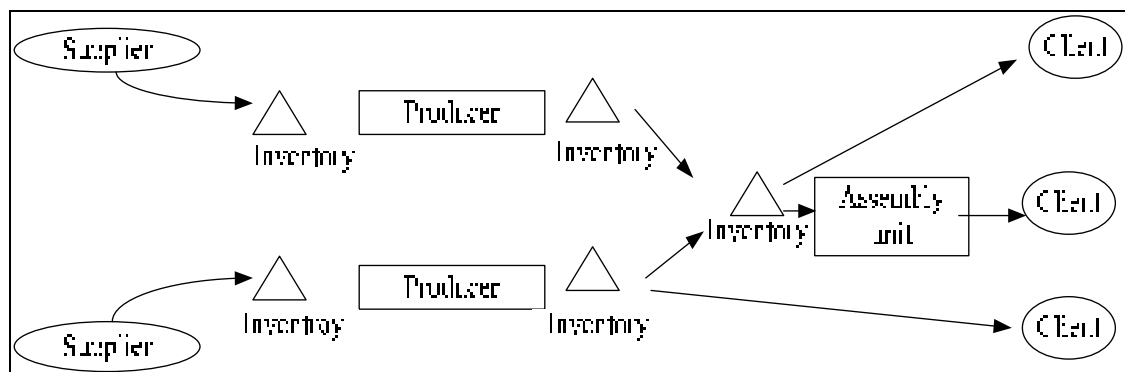

Figure 02 Supply chain representation.

New et al. (1995) proposed to represent the supply chain by activities and companies involved in the supply chain that begins with the extraction of raw materials until the distribution of products to customer and through production facilities, wholesalers and retailers. However, the most common definition of supply chain is a system of sub-contractors, producers, distributors, retailers and customers who exchange materials flow from suppliers to customers and information flow in both directions (Tayur et al., 1999).

There is also another type of definition that focuses more on the company. For example, Poirier and Reiter (2001) give the following definition : ” *a supply chain is the system where companies bring their products and services to their customers*”. In this context, several models have been proposed, and the Supply Chain Operations Reference (SCOR) model is one example that illustrates this type of definition (Supply Chain Council, 2006).

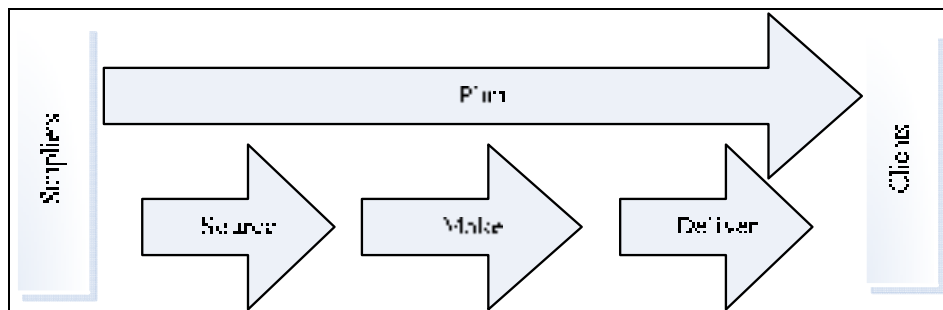

Figure 03 SCOR model - Level 1.
Adapted from Supply Chain Council (2006)

Supply chain management can be defined as decisions that optimize the performance of the network. More specifically, Metzger et al. (2001) propose the following definition: “*supply chain management can be defined as the systemic and strategic coordination of conventional operational functions and their respective tactics within the same enterprise and among partners within the supply chain in order to improve long-term performance of each member company and the entire supply chain*”. So, we should consider an enterprise often belongs to several supply chains for different products (or product families).

Traditionally, supply chain management was limited to the movements of products that start at the supplier level and finish after the delivery to customers. However, today supply chain operations need to be extended and consider the return of products. Reverse logistics of products may be due to several reasons: rework in the production process, commercial return, warranty return and return of the product after end of use. The management of products return flow must be made with the aim of achieving a compromise between the economic and the environmental (ecologic) objectives (Dekker, 2004). Depending on the type of returned products, the flows are routed according to five generic activities (see Figure 04): acquisition, selection, disassembly, cannibalization, and remanufacturing.

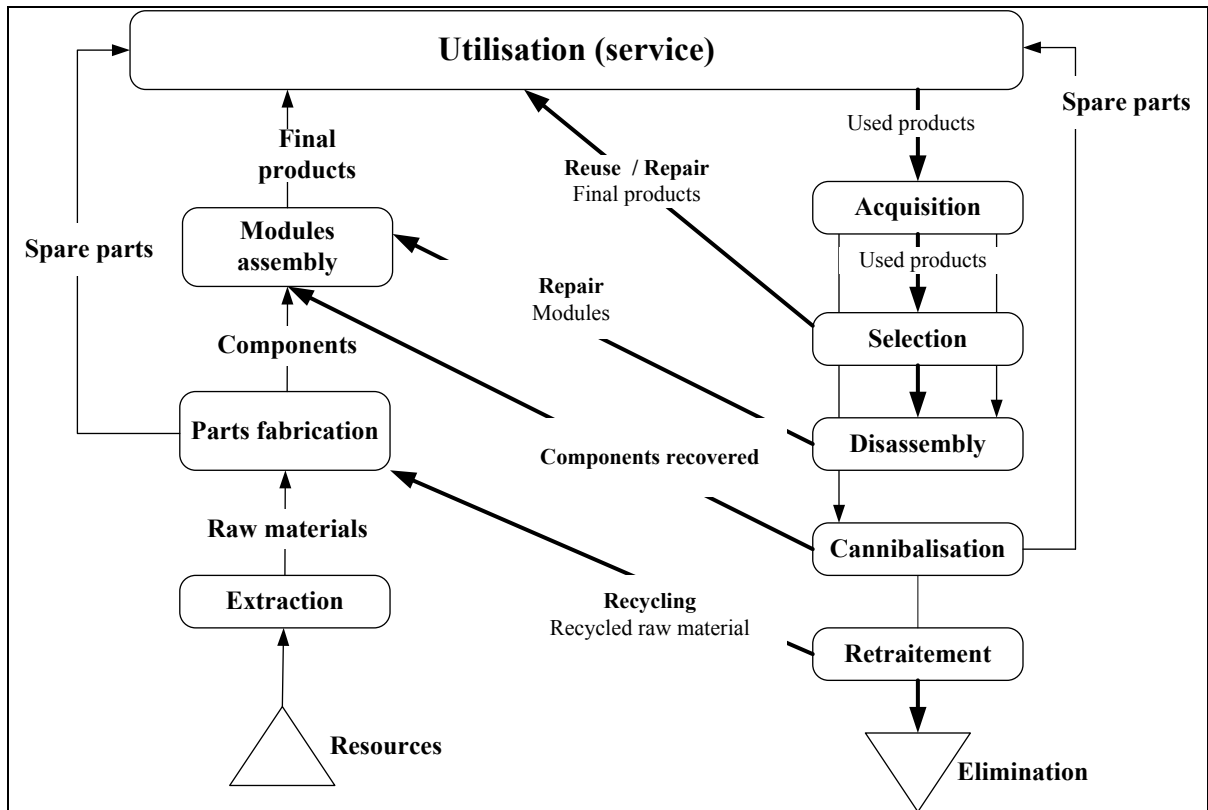

Figure 04 Logistics activities.
Adapted from Dekker (2004)

In addition, we recently noticed that several companies are more interested in a conscious and strategic use of resources. Quantification and assessing the impact of supply chain

operations in terms of emissions generated (liquid, solid and gases) are gaining importance in several industries (Srivastava, 2008).

In this case, the approach of Life Cycle Analysis (LCA) becomes more popular to support the strategic decision making process related to the planning of supply chain activities (De Benedetto et Klemes, 2009). It is based on the concept of sustainable development by providing a systemic and efficient tool to evaluate environmental impacts of products, services and processes. The main goal behind the use of a life cycle analysis approach is to reduce resources consumption and the damage that can cause industrial activities on the environment throughout its entire life cycle from the extraction of raw materials until the end of life of products (return, incineration, recycling, etc.). This concept is also known as the “cradle-to-grave analysis”.

It is clear that sustainable development recognize the interdependence between the three pillars of sustainability which are the economic, the environmental and the social objectives. Until now, sustainable supply chain management stress more on the economic and the environmental (ecologic) performance (Seuring et Muller, 2008b), the social criteria remains without a lot of interest. Recently, Hutchins et Sutherland (2008) have explored the subject and studied how to assess sustainability at the social level and its application throughout the decision making process for supply chains. They conclude that a similar approach to the LCA, which have been applied successfully to control the environmental dimension, could be adopted with some minor modifications to evaluate supply chain operations in terms of safety, quality of life and public life.

From the previous sections, we saw that the evolution of the concept of supply chain management have given rise to the concept of sustainable supply chain management. Indeed, many organization are realizing that sustainable development is a critical factor to achieve competitiveness and profitability. Seuring and Muller (2008) define sustainable supply chain management as *“the management of material, information and capital flows as well as cooperation among companies along the supply chain while taking goals from all three dimensions of sustainable development, i.e., economic, environmental and social, into*

account which are derived from customer and stakeholder requirements". To achieve sustainability objectives of the supply chain efficiently, we need to consider several decisions at different planning levels and phases of the product life cycle. In addition, it is important to be able to assess the impact at the same time of economic, environmental and social decisions under various rules dictated by the business environment.

The economic criteria (cost or profit) was often dominant (Martel, 2005), but the integration of other metrics such as flexibility, delivery reliability and supply chain responsiveness are increasingly introduced as key performance indicator to assess the supply chain (Pokharel, 2008; Sabri et Beamon, 2000). For example, Beamon (1999) proposed a framework for measuring the supply chain performance based on three pillars: resources, outputs and flexibility. On the other hand, when supply chain managers becomes more aware about the damage that causes supply chain operations on the environment (pollution, global warming), other performance indicators are added to evaluate the environmental performance and control harmful emissions (liquid, solid, and gases). In this perspective, some performance indicators have been introduced such as "Eco-Indicator 99" which offers a way to measure various environmental impacts and shows a final result in a single score to three categories: the impact on human health, the impact on the ecosystem quality and the impact on resources (Spriensma (2001) et Luo et al. (2001a)).

<p>Fact 1: Based on the preliminary analysis, it is clear that the assessment of sustainable supply chains should be based on several criteria to ensure that decision support systems (DSS) are efficiently used in different industrial contexts and sensitive to the supply chain environment.</p>
--

The environmental criterion is increasingly considered as an important dimension to integrate in managing several industrial sectors. Different forces pushed decision makers to this direction and are related to environmental legislations (for example, environmental legislation for manufacturers of chemicals products). Moreover, customers are more responsible about the use of non pollutant products with minimum energy consumption (for example, the automotive industry) and produced using clean technologies and even

going to ensure that production takes place in an appropriate social climate (textile industry). Thus, priorities change from one industry to another, but the goal is the same: guarantee the three pillars of sustainable development of the supply chains.

Initially, efforts towards reducing the environmental impact were based on voluntary actions to improve the image of products "green products". Subsequently, regulations were introduced nationally in several countries and involve many industrial activities. For example, for electronic and electrical products, several countries have imposed regulations on toxic wastes generated by its products. The laws are much stricter in Europe than in Canada and the United States. The Waste Electronic and Electrical Equipment (WEEE) regulation on waste of electrical and electronic equipments has become a European law in February 2003. It imposes targets on levels of collection, recycling and recovery of products at the end of life cycle (Waste Electronic Equipment and electrical, 2009). In Canada, since 2003, a non profit organization was founded and is implementing a program to collect electronic products at the end of life cycle for possible reuse (Electronics Product Stewardship Canada (EPSC), 2009). In the United States, laws vary from state to another. The Environmental Protection Agency (EPA) has developed a regulatory framework to encourage sustainable management of electronics and also for other sectors (U.S. Environmental Protection Agency, 2009).

Finally, this effort towards reducing the environmental impact has taken a global dimension. The Kyoto Protocol is considered the most important alternative at the global level and which aims is to combat climate change. Specifically, all countries are obliged to publish their inventories in terms of greenhouse gases (GHG) emissions. In addition, they must implement national programs to mitigate climate change. Thus, countries that ratified the protocol have introduced regulatory frameworks for GHG emissions such as those existing in Europe, Canada, England and Australia.

Therefore, due to the obligation of controlling the environmental performance in some sectors, different companies must evaluate their GHG emissions in order to comply with the new regulations. In addition, they must engage in a sustainable development process in order

to avoid penalties that may be costly for those involved in the supply chain. To help achieving these objectives, the Kyoto Protocol provides countries with the possibility to use flexibility mechanisms in addition to national policies and measures that they will implement (Faure et al., 2003). The flexibility mechanisms are: international emission trading (Peace and Juliani, 2009), Joint Implementation (JI) (Woerdman, 2000) and Clean Development Mechanisms (CDM) (Michaelowa and Jotzo, 2005). Finally, whatever the mechanisms used by companies to comply with various regulations, it is clear that environmental and social considerations may impose additional constraints and costs if managers fail to master the impact of such laws.

Fact 2: Based on the previous analysis, it is clear that the new trends of sustainable supply chain management combined with several environmental and social regulations (collection, recycling of product after their use, greenhouse gases emissions, safety, etc.), companies should identify the impact of such actions on the economic, environmental and social levels in order to adopt a sustainable strategy that supports future decisions.

Problem statement

Supply chains are becoming more and more complex. Taking into account the important elements to make the decision process more sustainable and close to the business environment is a major challenge for researches in the field of supply chain management. These elements can be summarized as following:

- the complexity of supply chain activities (large structure and interdependent decisions);
- the existence of several metrics for measuring and evaluating supply chain performances (objective of sustainable development);
- the dynamic environment of the supply chain (customers / markets, stakeholders, regulations, laws, etc.).

Supply chain design and performance evaluation integrates different criteria and objectives during the decision making process in addition to the uncertainty that may appear in this environment. In many situations, decision makers have to take decisions at different time span (long, medium or short terms), at different levels (supply, production, storage, transportation, recycling, incineration, etc.) and based on the available dynamic information (market, legislations, cost, etc.) while ensuring the sustainable development objectives (economic, ecological and social). We refer to such problems: multi-criteria design and evaluation of sustainable supply chains.

In one hand, in some cases, objectives in terms of sustainability are limited to the economic prosperity which is predominant factor. In this situation, strategic decisions are particularly important and require a detailed analysis to avoid the risk of errors. There are several tools and techniques such as mathematical programming, a well established area for the design of supply chains that can support efficiently the decision process. Mathematical modelling can solve problems with different levels of complexity. Moreover, multi-criteria methods (multi-attribute and multi-objective models) can be used in case of the presence of intangible factors to obtain more realistic solutions. Although this may add another level of complexity in modelling and solutions development, it offers a realistic decision process close the industrial context. On the other hand, and under environmental regulatory frameworks, an effective adaptation of the decision making process and performance evaluation for sustainable supply chain is a new reality for supply chain managers. Thus there is a real need for the development of decision making models that take into account the industrial reality which is more and more complex.

In this thesis, we propose to bring a contribution by considering the aspects presented before. In general, the structure of the supply chain to which we are interested is as shown Figure 05. We consider that there is a company that is the central purpose of the study. The company may have several manufacturing sites. The supply of manufacturing facilities can be from multiple vendors. The products are delivered to customers. Logistics facilities for the reverse logistics management (collection, recycling and recovery) are also considered. The product life cycle steps are also considered.

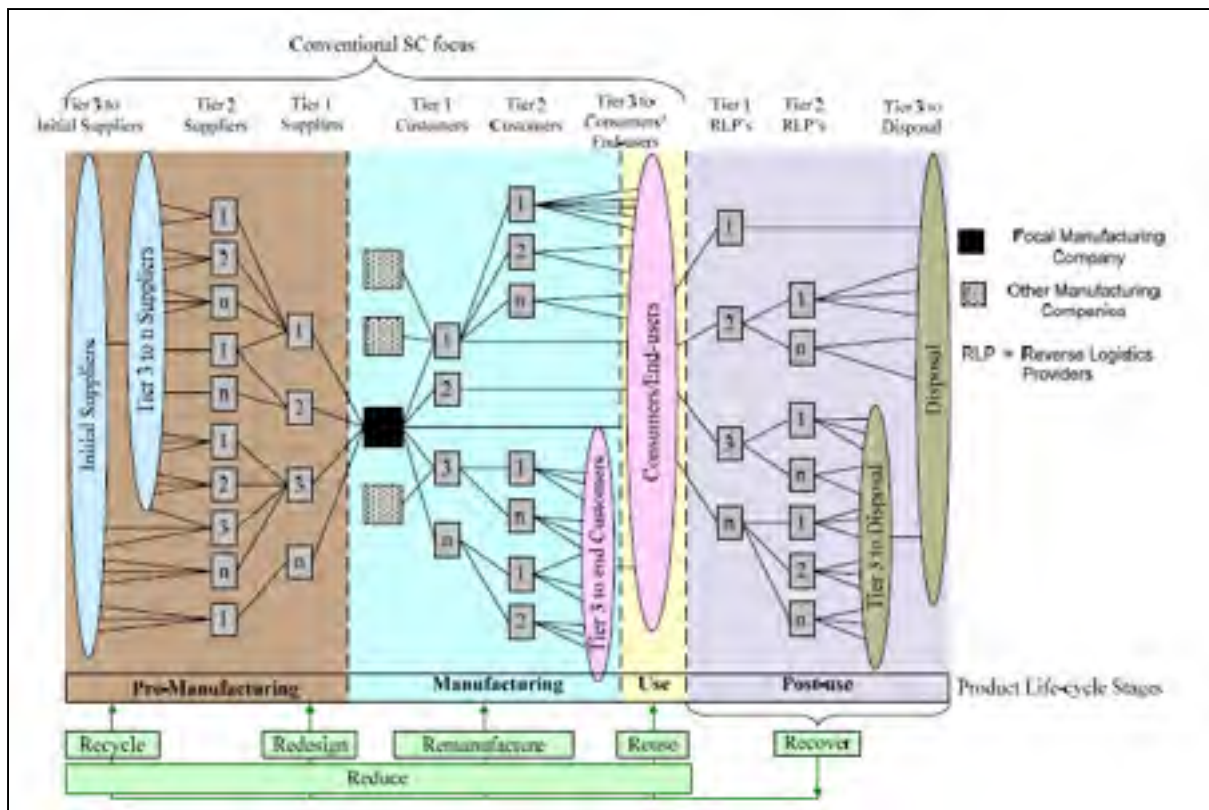

Figure 05 Structure of the supply chain in this study.
Adapted from Badurdeen et al. (2008)

In addition, we assume that the company has the opportunity to make benefit from the various mechanisms that will enable the achievement of sustainable development objectives. We can distinguish between two types of mechanisms that help achieve these goals:

- **Internal mechanisms:** the internal mechanisms represent all that policy makers may consider internally at the company in order to achieve sustainability. Generally, we will identify the list of potential feasible options at each phase of the product life cycle and we will select the best option to ensure to establish sustainable supply chains.
- **External mechanisms:** external mechanisms are options offered by external agencies (governmental or private) and may be in the form of incentives and opportunities to develop sustainable supply chains.

Thesis objectives

The main objective of the thesis is to provide supply chain managers with a set of decision support tools for designing and evaluating sustainable supply chains. The following figure (Figure 06) summarizes the objectives of this research which is to consider internal and external mechanisms to develop a decision-making process based on different criteria. The supply chain environment includes suppliers, subcontractors, investors, governments, markets, etc. In general, decisions to be taken consist of supply chain configuration, flow planning, management of product returns, emissions management and establishment of a carbon management strategy, to ensure economic prosperity (reduce costs, improve service to customers, increase profit, more efficient use of resources, etc), being green and therefore improve the social impact.

Research questions

As a result, to solve the problem of multi-criteria design and evaluation of sustainable supply chains, this research aims to answer two important research questions (Q1 and Q2):

- **Q1:** How to get an efficient supply chain design, integrating the relevant performance measures and taking into account at the same time strategic decisions (for example: supply chain design and reconfiguration) and tactical decision (for example safety stock placement) under a dynamic environment (for example: demand uncertainty) while avoiding the complexity that can arise in mathematical models dealing with these different elements?
- **Q2:** What to use the different mechanisms of sustainable development available by supply managers at the planning phase where the company is subject to environmental regulations (for example: cap on greenhouse gases emission)? And how can we get to sustainable supply chain design under different governmental regulations?

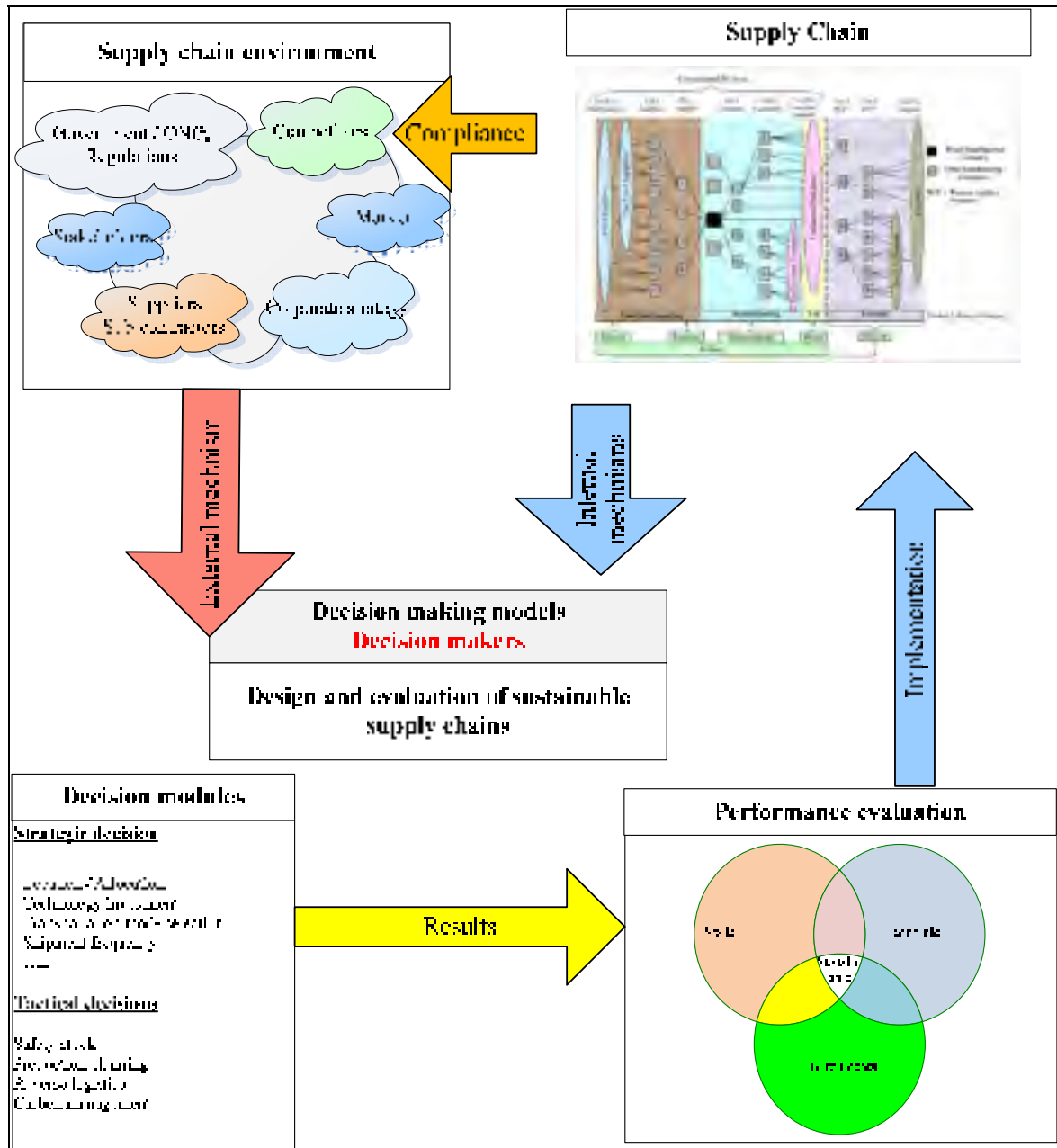

Figure 06 Thesis objectives.

Methodology

To tackle the problem and meet the research objectives introduced previously, the proposed methodology is based on the development of decision support tools in the form of mathematical optimization models. To consider the first observation previously introduced,

the need for integration of multiple performance measures (quantitative and qualitative) simultaneously, the use of multi-criteria analysis is advocated (Yoon and Hwang, 1995) (multi-attribute decision (MADM) and multi-objective (MODM)).

Despite the consistency of the use of a planning approach that integrates simultaneous different levels of decision making (strategic, tactical and operational), it is not adequate for real applications of decision making given the complexity of problem and data availability. Decision models based on hierarchical planning are more realistic (Lebreton, 2007). Indeed, work initiated by Hax and Meal (1975) on hierarchical production planning and subsequently adapted to the planning of the supply chain is used in many real cases (Miller, 2001). Also, many providers of advanced planning systems (APS) are based on hierarchical planning principles in their development (Meyr et al., 2005) which proves the relevance of such approaches at the application level. Thus, the proposed methodology also fits into a hierarchical planning process (see Figure 07). In the following, we briefly explain the various steps associated with the proposed methodology.

Step 1 (S1): Strategic decision – Supply chain configuration

In step 1, the objective is to achieve a supply chain configuration that meets the strategic objectives of the enterprise as well as the constraints imposed by its environment, and approaching the Industrial reality. This step involves two sub-steps (S1a and S2b):

- **S1a:** in this sub-step, the objective is to generate several supply chain network alternatives through a multi-objective optimization modelling approach that takes into account the economic and the environmental objectives. At this level, the decision maker does not need to specify his preferences (priorities). We obtain a set of networks that are analyzed in depth at the second step, E1b.
- **S1b:** In this sub-step, we propose to select a network for the supply chain by considering other criteria. The SCOR model metrics are preferred. The use of multi-attribute at this level will facilitate the selection process while considering decision makers preferences.

Step 2: Tactical decisions – Safety stock placement

Now, that the network structure is known, and we can proceed to the next step in order to determine the safety stock level required at each site to meet the service level required by the client in the presence of uncertainty in demand.

Step 3: Validation – Performance evaluation

At this stage, several tests and scenarios are analysed to simulate the performance of the supply chain. Indeed, considering the objectives in terms of economic growth and environmental impact reduction, decision makers are able to validate decisions to make in terms of product design, suppliers and subcontractors selection, production planning strategies and stock control, transportation mode selection, and reverse logistics activities to implement.

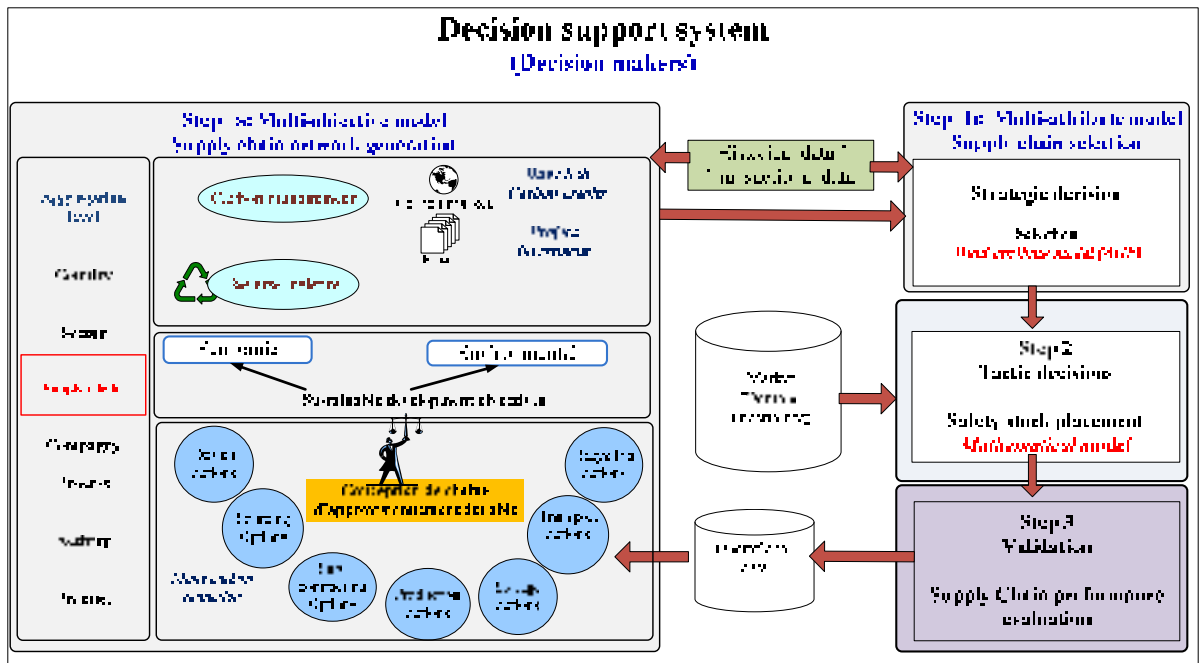

Figure 07 Proposed methodology.

Thesis structure and contributions

The thesis consists of four chapters. Chapter 1 is a literature review about planning models regarding the management of sustainable supply chains. The other three chapters are devoted to describe new methods for multi-criteria design and evaluation of sustainable supply chains. This research lead to publish four (4) refereed journal articles included in chapters 2, 3, 4, and Annex 1, twelve (12) international conferences and a presentation at a summer school. Finally we summarize the results as a conclusion with some research perspectives.

CHAPTER 1

LITERATURE REVIEW

Abstract

In this chapter, we present a literature review about sustainable supply chain management planning models and assess the ongoing developments in this area. Based on a detailed analysis of past and emerging issues, we establish a classification scheme that includes several dimensions. We conclude that most of modelling approaches are able to consider different managerial decisions (internal mechanisms) through the closed-loop supply chain in order to achieve sustainability. However, little attention has been given to the interaction with external mechanisms (legislations, carbon taxes, carbon market) to develop the new generation of advanced planning systems for managing sustainable supply chains. Moreover, this review reveals that the economic and the environmental dimensions are well considered in the evaluation of sustainable supply chain performance. However, the social impact is still neglected and need more exploration. Finally, we end this chapter with an integrated approach for sustainable supply chain management modeling that triggers directions for future research developments necessary in advanced planning systems.

1.1 Introduction

The topics of interests in this study are related to the field of supply chain management (SCM). For many years, the concept has evolved and continues to attract both academics and practitioners. An extensive literature developed by Capar et al. (2004) discusses the progress and applications of SCM theory. They used a classification scheme divided into six basic factors: (1) type of study, (2) structure of supply chain, (3) product properties, (4) supply chain activities, (5) decision making and degree of information sharing, and (6) solving

procedures. The following discussions will concentrate much more on decision making models and solution procedures factors. Also, we will stress more on the long-term and strategic planning models used to manage supply chains.

To date, several models/frameworks have been developed to give a better understanding of how to improve the supply chain efficiency. For instance, the emergence of decision-making models for strategic, tactical and operational planning continue to provide advancement in SCM theory in the form of sophisticated and advanced planning systems (Fleischmann et al., 2003; Stadtler et Kilger, 2000).

1.1.1 Past supply chain management models

Decision making and solution procedures methodologies have been widely used by both researchers and practitioners to establish strategic, tactical and operational planning. Strategic decisions dictate the supply chain configuration. Tactical decisions try to find best ways to serve customers through aggregate planning and scheduling. This includes decisions such as which markets will be supplied from which locations and the production and inventory policies enforced at each production location. The operational decisions find ways to expedite customer orders to meet customer's due dates (Chopra et Meindl, 2004). A detailed review of strategic, tactical and operational decisions making models can be found in Vidal and Goetschalckx (1997) and Bilgen and Ozkarahan (2004). Also, Schmidt and Wilhelm (2000) present a review of modeling and algorithms for the design of supply chain systems. We can classify existing models into two categories: single-criteria/objective models and multi-criteria/objective models. On one hand, single-criteria models concentrate on single objective function.

1.1.1.1 Single-criteria/objective models

The first approach considers that the SCM problem has only one objective function to optimize which usually represent the economic dimension. Enumeration of all models available in the literature is not possible. However, some specific models are selected

carefully in order to provide a comprehensive understanding about the basic elements of modelling approaches proposed in literature and applied to industrial case studies.

Fundamentally, strategic supply chain models have the same characteristics : objective function, decisions variables, and constraints for a single-country environment or in a multi-country environment (global supply chain) where exchange rates, tax rates, duties, tariffs, and local content laws are considered (Meixell et Gargeya, 2005).

Dogan and Goetschalckx (1999) develop a mixed integer programming formulation and a design methodology of the supply chain. Jayaraman et al. (2001) study a logistics model for locating production and distribution facilities in a multi-echelon environment using a mixed integer programming formulation. A heuristic solution procedure was used to solve the problem. In addition, Syam (2002) extends traditional facility location models by introducing several logistical costs, such as holding, ordering and transportation costs, in a multi-commodity, multi-location framework. Two heuristics based on Lagrangian relaxation and simulated annealing are provided to solve the model. Jang et al. (2002) introduce a supply network design model with a global bill of material (BOM). Experimental results show that the design and planning of supply chain networks with BOM consideration could be optimized using the appropriate strategies and algorithms.

Jayaraman and Ross (2003) address a distribution network design problem, which is characterized by multiple product families, a central manufacturing plant site, multiple distribution center and cross-docking sites, and retail outlets (customer zones) which demand multiple units of several commodities. Paquet et al. (2004) present a methodology to design a network of manufacturing facilities where the mission of each facility, the technology and the capacity are identified. A solution method based on Bender's decomposition is used. Gen and Syarif (2005) Study a production/distribution problem to determine an efficient integration of production, distribution and inventory system so that products are produced and distributed at the right quantities, to the right customers, and at the right time, in order to minimize costs. Vila et al. (2007) introduce an approach where market opportunities are considered in the

supply chain network design phase. The problem is formulated as a stochastic program. A sample average approximation method is used to solve the model.

From the previous specific models, we can see that strategic supply chain design integrates two planning levels : decisions on the supply chain network configuration and the mission of each facility, and planning decisions on the flows of goods in the network. Uncertainty from the environment could be considered also at this level. The economic objective (cost or profit) is influenced by the decisions on investments and configuration as well as by financial variables costs resulting from the planning decisions. The single objective based models consider that the economic dimension is the most important and there is no need to integrate other objectives such as customer services (quality, flexibility, responsiveness, *etc.*), or the environmental objective (greenhouse gases emissions, waste). For instance, sustainable supply chain management covers interactions among economic dimension, the environment, and society, and a realistic decision process should find a trade-off solution between different performances which are sometimes conflicting. Thus, the use of multi-criteria and multi-objective models is suitable in this case.

1.1.1.2 Multi-criteria/objective models

The second class formulates strategic supply chain decisions as a multi-criteria / multi objective programs (Cohon, 1978; Keeney et Raiffa, 1976; Steuer, 1986). The planning decisions are almost the same. However, additional objectives are added in the optimization process.

Very early, Arntzen et al. (1995) introduce a global supply chain model to manage complexity in an international context. The “weighted sum method” was used to minimize cost or weighted cumulative production and distribution times or both. Li and O’Brien (1996) focused on improving supply chain efficiency and effectiveness under four criteria: profit, lead-time, delivery promptness, and waste elimination. Sabri and Beamon (2000) develop a multi-objective supply chain model for simultaneous strategic and operational planning in supply chain design. The “ ϵ -constraint” method is used to minimize cost, while ensuring a

sufficient amount of volume flexibility and service level (fill rate). Nozick and Turnquist (2001) address the question of locating distribution centers. They show that the optimization of these decisions requires careful attention to the trade-offs between facility costs, inventory costs, transportation costs, and customer responsiveness. Chen et al. (2003) and Chen and Lee (2004) propose a fuzzy decision-making method to achieve a compromise solution among all participant companies of the supply chain in a decentralized context. Guillen et al. (2005) study the problem of design and retrofit of a supply chain consisting of several production plants, warehouses and markets, and the associated distribution systems. The approach enables management of financial risk associated to the different design options, resulting in a set of Pareto optimal solutions that can be used for making decisions. They use the “ ϵ -constraint” method with a branch and bound technique to solve a multi-objective stochastic model.

Shen and Daskin (2005) develop a nonlinear model to determine distribution center locations and the assignment of demand nodes to distribution centers in order to optimize the cost and service objectives. They use a “weighting method” to find all supported points on the trade-off curve. The results suggest that significant service improvements can be achieved relative to the minimum cost solution at a relatively small incremental cost. Altiparmak et al. (2006) propose a solution procedure based on genetic algorithm to find the set of Pareto-optimal solutions for multi-objective supply chain network design problem. Finally, Pokharel (2008) develops a two-objective decision-making model for the choice of suppliers and warehouses for a supply chain network design problem. He demonstrates that these decisions differ when two objectives, the cost and delivery lead times, are considered simultaneously.

In this context, Multi-objective Optimization (MOO) models provide decision makers with the possibility to understand the trade-off between different objectives and their impact on the supply chain configuration and planning decisions and costs. Different solutions methods could be used such as ϵ -constraint, weighting methods, and goal-programming. Although multi-objective optimization might add another degree of complexity to the decision process, especially when the decision makers have to give their preferences (weight for objectives), it is more representative to the real life strategic planning process.

1.1.1.3 Summary

In the previous section, we reviewed some representative models for the classic strategic decision making problem of supply chain management. The first conclusion is that strategic planning models need broader emphasis on integrating different complex supply chain activities (multiple production and distribution tiers) and the other product life cycle phases (reverse logistics). Moreover, the performance measures used in strategic decisions making models need to be expanded to address alternative criteria/objectives other than the financial dimension. For example, the Supply-Chain Council presents five performance metrics through the Supply Chain Operations Reference model (SCOR) (Supply Chain Council, 2006) : cost, reliability, flexibility, responsiveness, and assets. In addition, few attempts have been proposed to try integrating some tactical and operational levels at the strategic decision phase and this might be due to the complexity in term of resolution procedures or lack of data. That's why, usually a hierarchical planning approach is preferred (Ozdamar et Yazgac, 1999).

In the meantime, emerging issues such as increasing energy prices, limited resource availabilities and concerns for improving quality of life have lead to the focus on sustainable operations (Paul R. Kleindorfer et al., 2005). Incorporating sustainability into supply chain practices requires a shift in the SCM paradigm with an emphasis on the economic prosperity, environmental protection and social security. In order to promote sustainable supply chain management (SSCM), much broader focuses integrating all the relevant components is essential (Foran et al., 2005). While strategic decisions making models are challenging in its own right, environmental policies and sustainability objectives force supply chain managers to address different additional trade-offs.

1.1.2 Literature review plan and methodology

In the following section, the purpose is to assess how well the existing model-based literature supports sustainable supply chain management practices. The development of a classification

scheme that focus on these practical considerations add a clarity and better understanding of earlier research on this area. To assess this fit, we use five dimensions :

1. **Supply chain processes** : this dimension will help the understanding of the different process that might be covered when implementing sustainable supply chain practices.
2. **Decision scope** : this dimension concentrate on the different specific decisions related to the strategic/tactical planning of sustainable supply chain;
3. **Performance measure** : the performance measurement dimension identifies the nature of measures used to evaluate the supply chain performance;
4. **Solution procedures** : this dimension stress on the solution procedures used to solve the strategic planning problems while considering sustainability objectives;
5. **Application in industry**: Finally, this dimension will show the different fields interested in implementing sustainable operations.

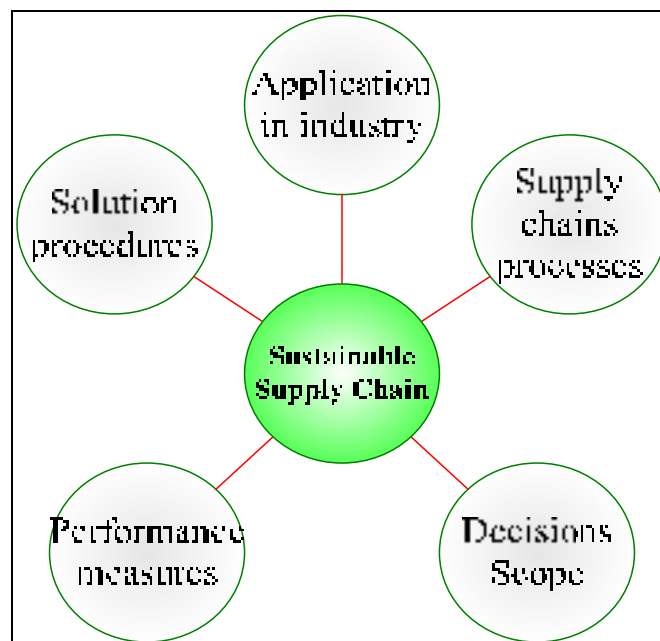

Figure 1.1 Taxonomy of SSCM planning models.

The proposed taxonomy of SSCM planning models ensure that all possible aspects of the planning problem are discussed and taken into account in decision-making models for sustainable supply chains.

1.2 Decision models for sustainable supply chain management

Different companies especially in the automobile, computer, and apparel industries have designed their supply chains by opening facilities in international locations. Suppliers are selected based on their ability to meet quality, quantity, delivery, price, and service needs of the firms. So, little attention has been given to the impact of local and international activities on the environment and the quality of life. But with an estimation of \$93 for marginal damage cost of each ton of carbon dioxide (CO₂) emissions (Tol, 2005), capping greenhouse gases (GHG) emissions and putting a price tag on them through the introduction of carbon markets (Johnson et Heinen, 2004; Peace et Juliani, 2009; Wara, 2007) or carbon taxes (Baranzini et al., 2000) became inevitable. Environmental regulations are becoming stronger than every time before and impose more constraints into energy use. Take-back legislations (Atalay Atasu et al., 2009) and reverse logistics activities (Dekker, 2004; Fleischmann et al., 1997) are now integrated in different industrial sectors. Thus, it is not surprising to see that Corporate Social Responsibility (CSR) and green initiatives are on the rise. A number of organizations have already made the move and they are lessening their harmful impact on the environment while reducing different logistics costs. For example, Texas Instruments saved 8 million USD each year by reducing its transit packaging budget for its semiconductor business through source reduction, recycling and use of reusable packaging systems.

CSR and Sustainable supply chain management (SSCM) (Seuring et Muller, 2008b) recognize the interdependence of ecological, social and the economic performances which are the three pillars of sustainability. Currently, there are a number of more or less isolated views in the literature that strive to address different aspects of sustainable business practices and strategic planning of sustainable supply chains. Recent papers (Seuring et Muller, 2008b; Srivastava, 2007) present an extensive literature review of different elements related to

supply chain sustainability : green design (Hugo et Pistikopoulos, 2005; Hugo et al., 2005), inventory management (Ferretti et al., 2007), production planning and control for remanufacturing (Jayaraman et al., 1999a; Luo et al., 2001b), product recovery (Jayaraman, 2006), reverse logistics (Sheu, 2008; Sheu et al., 2005), waste management (Ferretti et al., 2007) , energy use (Dotoli, 2005), and GHG emissions reduction (Ferretti et al., 2007; Guillen-Gosalbez et Grossmann, 2009; Ramudhin et al., 2008). To provide a better understanding of sustainable supply chain planning models, we propose in the following a systemic view of such development through a well structured taxonomy that consider a classification of five components (see Figure 1.1).

1.2.1 Sustainable supply chains processes

Supply chain processes are very complex. Achieving sustainability has led to the development of different theories applied at different levels. Corporate social responsibility (Andersen et Skjoett-Larsen, 2009; Maloni et Brown, 2006), sustainable supply network management (Young et Kielkiewicz-Young, 2001), supply chain environmental management (Lippmann, 1999), green purchasing strategies (Hokey Min et William P. Galle, 1997), environmental purchasing (Steve V. Walton et al., 1998), green marketing (Atasu et al., 2008; Ottman et NetLibrary Inc., 1998), reverse logistics (product returns, source reduction, recycling, material substitution, reuse of materials, waste disposal, refurbishing, repair, and re-manufacturing) (Barker et Zabinsky, 2008);(Dekker, 2004), environmental management (Robert Handfield et al., 2005), and life cycle assessment (Hagelaar et van der Vorst, 2001) are some of the theories that are available today and support efforts toward sustainability.

The communality between all these theories is that SSCM requires an extended approach beyond the classical approach studied in literature. Indeed, sustainable supply chain are better understood within the context of end-to-end key processes depicted in Figure 1.2 and adapted from the Supply Chain Operations Reference model (Supply Chain Council, 2006).

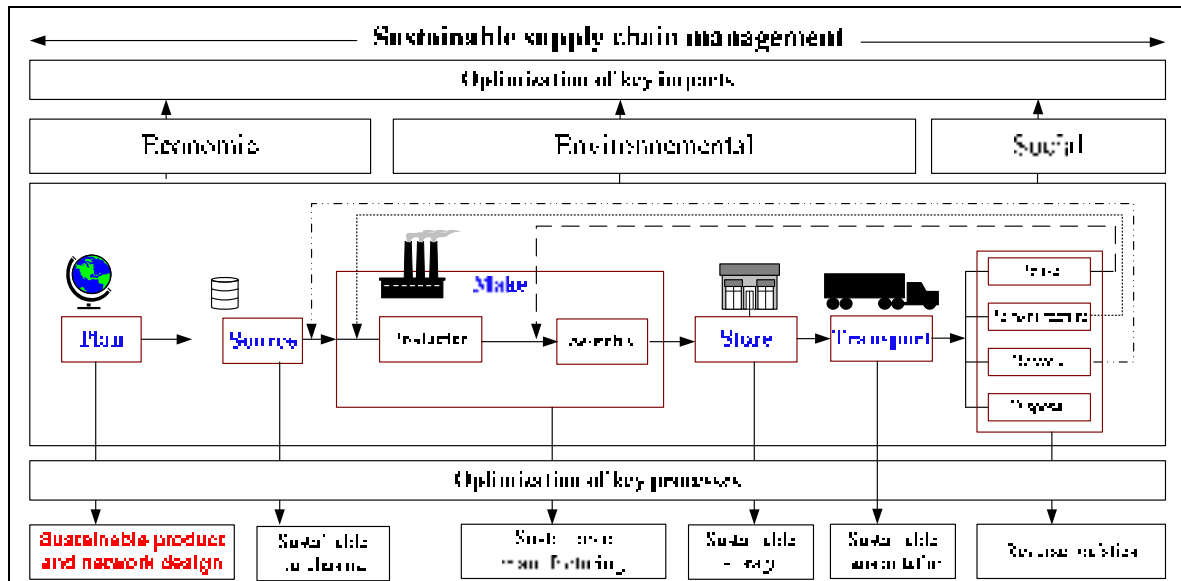

Figure 1.2 A strategic framework for sustainable supply chains.

The “*Plan*” process contains activities performed at the strategic level. It includes product lifecycle management (PLM) and optimization of the supply chain network design. The “*Source*” process concern the purchasing of different items including raw materials to manufacture products, offices supplies and furniture, electronic systems, and services. The “*Make*” process includes activities of production and assembly after product and network design using production technologies, purchased material, and other resources like worker and energy. The “*Store*” process in SCM concern the selection, design, and configuration of warehouse space, management of inventory receiving, management of raw materials or finished products inventory, and picking activities. The “*Transport*” process in supply chain management involves fleet vehicle management and the inbound and outbound transportation of goods. “*Reverse logistics*” is the process of moving goods back from their final destination toward the points of origin : reuse in the assembly process, remanufacture in the production process, recycle and used as new raw material in the manufacturing process or for proper disposal and incineration.

Next, we propose a characterization of these key processes through the decisions that might be included at each level. This framework (see Figure 1.2) extend the Supply Chain

Operations Reference model and can be considered as a future guide for developing decision making models for SSCM.

1.2.2 Decisions scope

In this section, we will introduce the different decisions related to sustainable supply chain management practices. The link between supply chain processes and managerial decisions is considered and discussed.

1.2.2.1 Sustainable product and network design

The “*Plan*” process considers strategic and long-term decisions that might influence sustainability. Sustainable product and network design should be integrated together at this level in order to anticipate the performance of the supply chain. In one hand, product lifecycle management takes into account that products need to be managed through design, production, operation, maintenance and end of life reuse or disposal. Product design and packaging influence the efficiency and effectiveness of the supply chain activities, and later logistics cost, waste, and GHG emissions (Roy, 2000). That’s why there could be considerable benefits in designing supply chains taking into account the operation of the supply chain as well as the design of the product and the design of the manufacturing processes used in the supply chain (Blackhurst et al., 2005). Sustainable product design could be integrated in the phase of supply chain configuration (Maxwell et van der Vorst, 2003). The decision process might include the selection of product configuration and materials to use to achieve sustainability. For example, Krikke et al. (2003) develop a quantitative model to support decision-making concerning both the design structure of a product (modularity, reparability and recyclability), and the design structure of the logistic network. The model is applied to a closed-loop supply chain design problem for refrigerators. Subramanian et al. (2009) propose a model where product design decisions are integrated in the supply chain coordination process under the Extended Producer Responsibility (EPR) legislation which focuses on the life-cycle environmental performance of products. First, they demonstrate how charges during use and post-use can be applied as levers to encourage environmentally

favourable product design. They also analyze the impact of supply chain coordination on design choices and profit.

In the other hand, supply chain network design is the second important decision in the plan process. Indeed, competitive markets, pressure to reduce inventory, costs and GHG, merger activities, rising energy and fuel costs are the most common incentives for a corporate to examine the supply chain network and define the number, type, location of manufacturing and distribution facilities, the transportation channels and modes used to serve customers, and collection/re-processing facilities. Including environmental and social impacts with the traditional financial impact allow companies to reduce the harmfulness to the environment while still achieving financial targets.

Once again, mathematical models play an important role to establish a framework for sustainable supply chain network design. Min and Melachrinoudis (1999) present a model involving the re-location of manufacturing and distribution facilities based on different criteria/attributes: site characteristics, cost, traffic access, market opportunity, and quality of life. Zhou et al. (2003) present a long range planning and investment decision making simultaneously with sustainability being considered. A multi-objective multi-period mixed integer nonlinear programming model is formulated to streamline the operations and suggest design modifications that will improve the efficiency and sustainability of the supply chain. Hugo et Pistikopoulos (2005) present a mathematical programming-based methodology with explicit inclusion of life cycle assessment (LCA) criteria as part of the strategic investment decisions related to the design and planning of supply chain networks. Strategic decisions involve the selection, allocation and capacity expansion of processing technologies and assignment of transportation links required to satisfy the demands at the markets. At the operational level, optimal production profiles and flows of material between various components within the supply chain are determined. Nagurney et al. (2007) develop a new supply chain model in which the manufacturers can produce the homogeneous product in different manufacturing plants with associated distinct environmental emissions. Frota Neto et al. (2008) develop a framework for the design and evaluation of sustainable logistic networks where main activities affecting environmental performance and cost efficiency in

logistic networks are considered. Guillen-Gosalbez and Grossmann (2009) present a supply chain network design model to determine the SC configuration along with the planning decisions that maximize the net present value and minimize the environmental impact. The model includes structural and planning decisions.

1.2.2.2 Sustainable purchasing

The “*Source*” process is the second level where sustainability could be achieved. Sustainable purchasing practices within the supply chain shall promote the use of green (environmental) products in acquisition of goods and services. Environmental and social factors should be considered in the purchasing process. This includes what the product is made from, where it is made, how it can be reused or recycled, who has made the product, its durability and the efficiency of the product during use and the processes involved in its production and distribution. Integration of environmental criteria in the supplier selection process could be added when evaluating supplier performance (Humphreys et al., 2003). Collaboration with suppliers is another way to achieve sustainability. Theyel (2006) shows that firms who collaborate with their suppliers can achieve a great performance in term of waste reduction and meet their customers’ environmental standards efficiently. Also, when purchasing decisions are done, buyers are invited to consider not only the cost, but also life cycle effects from GHG emissions, waste generation, energy consumption, recycled material content, and potential impact on health and nature (Lu et al., 2007). In most of the application related to sustainable purchasing, the economic and the environmental are the most studied, the social performance is relatively absent.

1.2.2.3 Sustainable manufacturing

The “*Make*” process (production and assembly) is very important within sustainable supply chain management (sustainable operations). Sustainable manufacturing is the creation of goods (products, components, modules) using processes and systems that are: non-polluting (less GHG emissions), conserving of energy and natural resources, economically viable, safe and healthful for workers, communities and consumers. Techniques that guarantee minimum

energy and resource consumption and reduce the use of virgin materials are based essentially on lifecycle assessment analysis. Sustainable manufacturing vary from one field to another. But basically, technology acquisition and planning decisions are made with taking into account that : wastes and ecologically incompatible by-products are reduced, eliminated or recycled (Mellor et al., 2002). Moreover, chemical substances or physical agents and conditions that present hazards to human health or the environment are eliminated (Albino et Kühtz, 2004). Energy and materials are conserved, and the forms of energy and materials used are most appropriate for the manufacturing process (Ferretti et al., 2007; Lam et al., 2009). Finally, work places and technologies are designed to minimize or eliminate chemical, ergonomic and physical hazards.

1.2.2.4 Sustainable storage

Sustainable storage activities are related to the “*Store*” process. There are different practices to improve the efficiency of energy use and reduce the environmental and social footprint of warehousing activities. This can be summarized through the incorporation of sustainability factors in new warehouse development and the optimization of warehouse layout and workflow: automate inventory handling, increase energy efficiency of warehouse operations, reduce inventory obsolescence or degradation, and handle and store hazardous materials safely. Sustainable storage is a relatively new concept and many aspects are subject to future research.

1.2.2.5 Sustainable transportation

Transportation is a very important in the supply chain activities. It provides the infrastructure to move products (flow) through the supply chain. However, the use of transportation systems have some negative effects (pollution, congestion, accidents) and need a specific attention to develop sustainable transportation networks (Nagurney, 2000). Decision related sustainable transportation can be applied to in-house or outsourced transportation such as: manage lifecycle performance of delivery fleet, shift to mode or equipment that use less fossil fuel (MacLean et Lave, 2003; Ramudhin et al., 2008), optimize transportation loads

and routes, use reusable or recyclable shipping materials, and transport hazardous materials safely. Transportation planning has been always considered as operational supply chain decisions. However, in sustainable supply chain management, this might be subject to change especially for company where transportation activities represent a big issue.

1.2.2.6 Reverse logistics

The final step that closes the supply chain (closed-loop supply chain) is the reverse logistic (RL) process (Savaskan et al., 2004). It is considered as a critical part product life cycle management and depends strongly on the “*Plan*” process where products are designed (Schultmann et al., 2006). Moreover, RL activities are mainly driven by economic and regulatory legislations (Atalay Atasu et al., 2009). Although, there are different point of views about RL activities, the general process can be represented as follows (see Figure 1.3) based on the seminal work of Fleischmann et al. (1997, 2000). First there is collection, next there is the combined inspection / selection / sorting process, thirdly there is recovery, and finally there is redistribution (Fleischmann, 2000; Fleischmann et al., 1997; Fleischmann et al., 2000).

Collection consists of moving products from the customer to a certain point of the supply chain (collection centers). After that, products are inspected. Products can then be sorted and routed according to the recovery path. If the quality is “good”, products are integrated in the market through *re-use*, *re-sale* and *re-distribution*. If not, another type of recovery may be involved but now demanding more action, i.e. a form of *re-processing*. Re-processing can occur at different levels : product level (*repair*), module level (*refurbishing*), component level (*remanufacturing*), material level (*recycling*), energy level (*incineration*). If none of these recovery processes occur, products are likely to go to landfill (*disposal*).

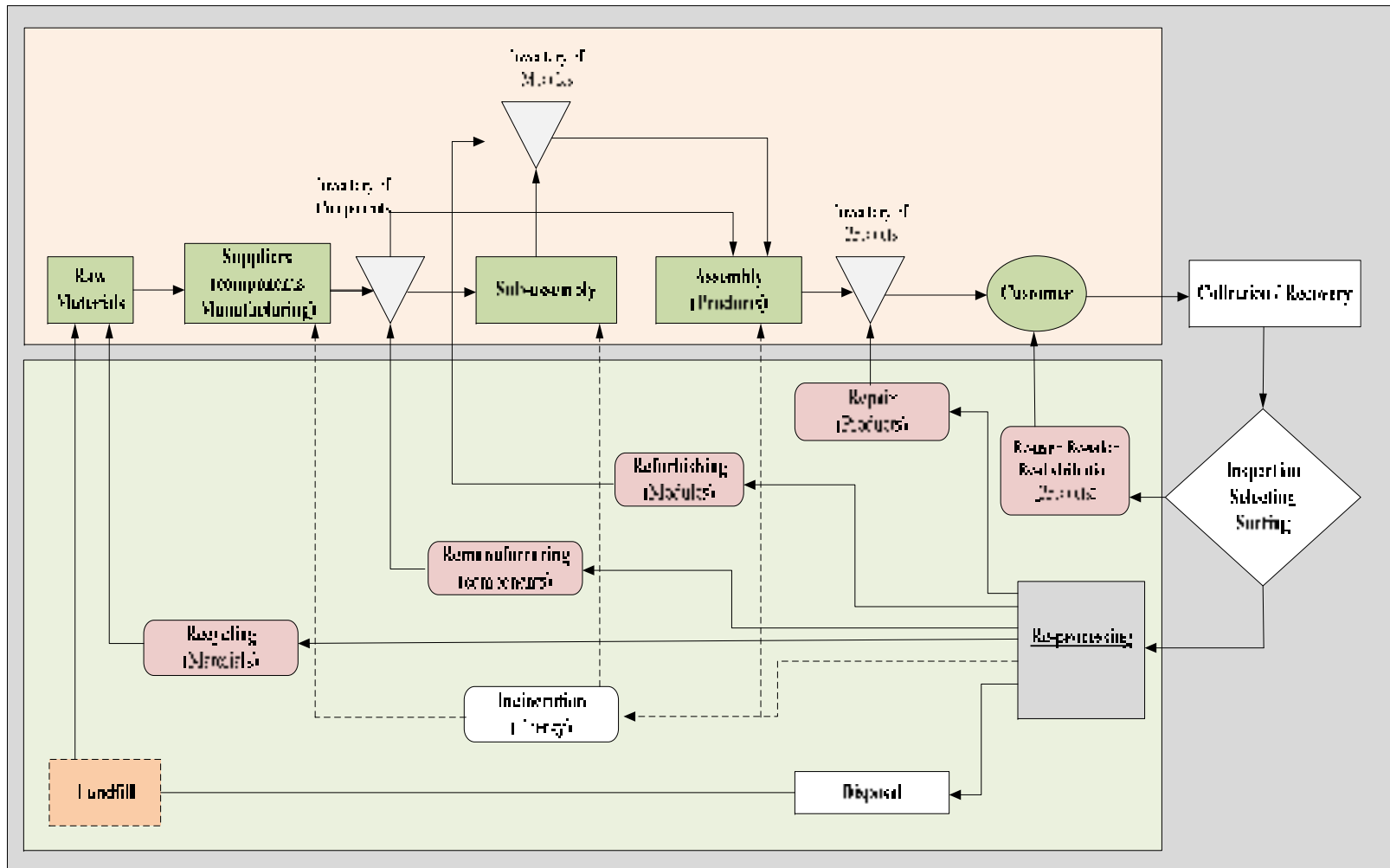

Figure 1.3 Closed-loop supply chain.
Adapted from Fleischmann et al. (1997, 2000)

The literature about RL (Rubio et al., 2008) and closed-loop supply chain (Guide et Van Wassenhove, 2009) is very abundant. Recently, Barker and Zabinsky (2008) propose a conceptual framework for decisions making based on different case studies. Basically, two main challenges faces compaignies in RL strategic planning: (1) how to build product recovery activities integrated with traditional forward logistics networks? and (2) how to manage the impact of uncertainty in the reverse logistics supply chain? Moreover, they stress on the development of decision making model that integrates high level configuration decisions to assess the efficiency of network design, using multi-objective programming and probabilistic approaches to manage uncertainties.

In addition, Rubio et al. (2008) present a detailed review of more than 180 published papers within the period 1995-2005. They came to the conclusion that for many years, RL have been analysed from tactical and operational point of view. Now, RL research should stress more on analysing strategic aspects to establish an appropriate reference framework. Fleischmann et al. (1997) provide detailed review of quantitative RL models and different mathematical formulation. They particularly show the differences and the similarities with classical mathematical model for “forward” supply chains. Also, the recent published book of Pochampally et al. (2009) gives a better understanding about the different decisions related to RL at the strategic, tactical and operational levels with some generic models. Strategic planning of RL activities should be integrated at the design phase of the supply chain network (Srivastava, 2008) and it is concerned with the location of recovery centers and their missions as well as the planning of flow and activities of used products : product recovery, re-use, remanufacturing, recycling and disposal.

Here, the objective is not to give an extensive literature review about RL models. But, our main goal is to identify the basic strategic aspects for planning sustainable supply chains through the integration of RL activities. Thus, we propose a classification that divides literature in two parts. The first one will describe briefly literature about strategic assessment and incentives toward closed-loop supply chains. The second part will stress more on strategic planning of closed-loop supply chains with supply chain management issues.

The integration of reverse logistics activities in supply chain management has always been a controversial issue. The main question that a supply chain manager will try to answer as a first step in the process is : ***Do we need to care about product's recovery?*** In response to that, many authors have explored the subject (De Brito et Dekker, 2003), and they came up with the conclusion that generally, companies are involved in RL because they might make profit from it (the economic incentive); or/and 2) because they have to care about RL (mandatory legislation); or/and 3) because they feel socially motivated to do it (Corporate citizenship and voluntary action).

From an *economic* perspective, the motivation behind the implementation of RL programs is the possibility to make profit through cost reduction of raw materials, components and parts acquisition. This is true especially for industrial context where products arrive at the end of their useful life in a short period with components and materials still usable. Guide et al. (2005) show how “ReCellular”, a U.S. firm operating in collection, reuse and recycling of mobile phones and electronic devices, makes profit by trading in used cell phones. Moreover companies, where the acquisition of raw materials costs more than recycling materials, can take advantage from that. Theoretical models and industry applications in RL are presented in a comprehensive manner in Guide (2000) and Gungor et Gupta (1999).

Apart from the economic aspect, the second driver for take-back and recovery of products is to be in compliance with legal requirements (*legislations*). Legislations refer to rules (laws and regulations) that consider companies responsible for product recovery and environmentally treatment after use. In the pulp and paper industry and the metal industry, the use of scrap as a raw material for new products is frequently used (Schultmann et al., 2004). However, for other products which are not recovered sufficiently, companies have been forced to implement programs for recycling a defined fraction of products in the market. For example, manufacturers of electrical and electronic equipment in Europe now have to comply with the Waste Electrical and Electronic Equipment (WEEE) and Restriction of Hazardous Substances (RoHS). Regulators in Europe have also implemented industry-specific legislation such as the EC's End of Life Vehicle directive (ELV) that requires automobile manufacturers to take back vehicles at the end of their useful lives (Directive

2006/12/EC). The directive set also clear quantified targets for reuse, recycling and recovery of vehicles and components and encourage producers to manufacture new vehicles which are easy to recycle. In Canada and United states, there are also similar regulations.

Finally, “*corporate citizenship*” is the third driver and concerns a set of values that a company can integrate to become responsibly engaged with reverse logistics. Although several differences can be found between the drivers towards integrating reverse logistics activities, in most of the cases, aspects from the three drivers might occur when establishing sustainable supply chains.

Once the strategic relevance of closed-loop supply chain is identified and it is decided to implement reverse logistics activities, the next step is the “*elaboration of strategic planning of closed-loop supply chains*”. Although the novelty of this research area, once again different quantitative models have been proposed (Pochampally et al., 2009). As for the classical strategic supply chain network planning, product design has an important influence on the design of closed-loop supply chain as shown in (Krikke et al., 2003; Lebreton, 2007). Various issues are faced by strategic planners of reverse and closed-loop supply chains : selection of used products (Xanthopoulos et Iakovou, 2009), evaluation of collection centers (Beamon et Fernandes, 2004), evaluation of recovery facilities (Wadhwa et al., 2009), optimization of transportation of goods (Lieckens et Vandaele, 2007a; Louwers et al., 1999), evaluation of marketing strategies, evaluation of production facilities, evaluation of futurity of used products, selection of new products, selection of second hand markets, synchronization of supply chain processes and supply chain performance measurement.

Most of the proposed models stress on the product selection process, the location of asset recovery centers, and the determination of recovery paths and technology selection. An economic objective is usually used in order to minimize the total costs including reverse logistics activities or to maximize the profit. Although the difficulty related to the development of a generic model for closed-loop supply chains and because it is a very context dependent problem, the integration of product design with the location in the decision process is fundamental.

1.2.3 Performance measure

Suitable performance measures in evaluating the supply chain are important and directly affect their applicability (Gunasekaran et al., 2004). Various types of performance measures have been used to evaluate sustainable supply chain. Most frequently, they combine the economic performance with the environmental performance in order to find the trade-off between the two performances (Frota Neto et al., 2008; Guillen-Gosalbez et Grossmann, 2009; Lu et al., 2007; Pistikopoulos et Hugo, 2005; Sheu et al., 2005). The economic dimension represents the cost or the profit in net present value (Pistikopoulos et Hugo, 2005). Various performance metrics have been developed to evaluate quantitatively the environmental impact of products, processes and activities such as the emissions of GHG (CO₂, CFC, NO_x, ...) (Luo et al., 2001b), waste generation (liquid or solid), energy use, and material recovery.

In recent years, different comprehensive environmental performance metrics has been proposed such as the “Eco-indicator 95” (Brentrup et al., 2001), “Eco-indicator 99” (Contreras et al., 2009), “Ecological Footprints”, and “EcoPro” (Luo et al., 2001a). These metrics are based on different methodological structures and weighting techniques where assumptions are different.

1.2.4 Solution procedure

It is not surprising to see that mathematical modelling based methodologies are the most commonly used. Multi criteria decision-making and Multi-Objective Optimization (MOO) are able to consider conflicting objectives (Cohon, 1978). It enables modeling of many problems in sustainable supply chain management problems. Different MOO models have been proposed ((Giannikos, 1998)(Luo et al., 2001b) (Frota Neto et al., 2008) and (Guillen-Gosalbez et Grossmann, 2009)) and show the importance of considering multiple objectives in managing sustainable supply chains in order to find compromise solutions in case of the presence of conflicting objectives such the economic and the environmental dimension of sustainability. Methods such as Analytic Hierarchy Process (AHP) (Min et Melachrinoudis,

1999; Sarkis, 2003) (Dotoli et al., 2005; Dotoli et al., 2006), epsilon-constraint method (Hugo et Pistikopoulos, 2005) and goal programming (Zhou et al., 2000) are developed to analyze the impact of adding environmental constraints on the supply chain network planning decisions.

1.2.5 Applications in industry

The applicability of different supply chain models have been tested in real industrial cases and in different fields : petrochemical production (Zhou et al., 2000), aluminum industry (Ferretti et al., 2007), personal computer (Dotoli et al., 2005; Dotoli et al., 2006; Min et Melachrinoudis, 1999), and the pulp and paper industry (Frota Neto et al., 2008). It shows particularly that numerous initiatives have provided incentives for organizations to become more sustainable. Some of these regulations are mandatory, but increasingly others are just voluntary environmental programs and considered as new alternatives for gaining or maintaining a competitive advantage. For instance, many industries are engaged in voluntary RL activities like the automotive industry (Schultmann et al., 2006), cellular telephones (Jayaraman et al., 1999b), computers (White et al., 2003), pulp and paper industry (Frota Neto et al., 2008) because they can achieve additional profit.

1.3 Discussion

Sustainable operations management (Paul R. Kleindorfer et al., 2005), sustainable logistics networks (Frota Neto et al., 2008) and sustainable supply chain management (Carter, 2008; Seuring et Muller, 2008a; 2008b) have received an increasing attention. As mentioned earlier, strategic supply chain decisions based on economic sustainability have been well covered in the literature (Meixell et Gargeya, 2005). These models integrate the decisions regarding the selection of facilities at international locations, the capacity of each facility, the assignment of market regions to locations, supplier selection for sub-assemblies, components and materials, recovery of product and re-processing. Total logistic cost optimization or profit maximization is the most performance measurement used to tackle the problem. In general, the cost structure includes two important types of costs : fixed costs and variables

costs. Fixed costs include the cost of different long-term investment (opening and closing facilities, technology acquisition, new product design, *etc.*). The variable part includes the raw materials costs, sub-contracting and production costs, inventory costs, and distribution expenses including transportation between the different supply chain nodes, collection of product after use, remanufacturing, recycling, redistribution, taxes, duties, *etc.* The environmental and social performances are also considered. Effort toward sustainability might be achieved through different actions related to one or more phases of the product life cycle such as product design (Hugo et Pistikopoulos, 2005; Hugo et al., 2005), production planning and control for remanufacturing (Jayaraman et al., 1999a; Luo et al., 2001b), inventory management (Ferretti et al., 2007), product recovery (Jayaraman, 2006), reverse logistics (Sheu, 2008; Sheu et al., 2005), waste management (Ferretti et al., 2007), energy use (Dotoli, 2005), and GHG emissions reduction (Ferretti et al., 2007; Guillen-Gosalbez et Grossmann, 2009). In addition, Life cycle management (LCM) principles expanded the scope of the environmental management system of a company to include the impacts associated with the activities of the supply chain in different life cycle phases (raw material extraction, production of sub-assemblies, production of main products, use and reverse logistics (recycling, recovery, *etc.*)). Thus, “strategic decisions-making planning tools” that encapsulate both “LCA principles” and “Closed loop supply chains” are with a great potential of application and will continue to interests both practitioners and academics in the area of SSCM. We strongly believe that this integration will facilitate the development of SSCM practices in the future.

Finally, the most important conclusion that should be noted is that pressures and incentives towards sustainability in supply chains are mostly triggered by government regulation, customers and stakeholders (Seuring et al., 2008). Usually, this pressure is transmitted to suppliers and pushes the company to look to the entire supply chain (closed-loop supply chain) in order to achieve the mandated or voluntary sustainable objectives. However, few studies have addressed the impact of integrating the external mechanism (government regulation, take-back legislation, GHG emissions, carbon taxes, carbon markets, *etc.*) on sustainable supply chain management practices and the development of managerial decision-

making. For instance, Nagurney et al. (2006) is one of the first studies that addresses carbon taxes in the electric power supply chains with power plants. Also, Subramanian et al. (2008) propose an approach to integrate environmental consideration within managerial decision making. A non-linear mathematical programming model is introduced that allows the incorporation of traditional operations planning considerations (capacity, production and inventory) with environmental considerations (design, production and end-of-life). Decisions on the number of carbon credits purchased and sold in different periods are added under the limitation of carbon emissions.

1.4 Toward an integrated approach for SSCM

As concluded in the previous section, strategic sustainable supply chain management is complex and should integrate different aspects. As for classical models, we can define two planning levels : strategic structural decisions on the supply chain configuration and planning decisions on the flows of goods in the network (closed-loop supply chain).

As shown in Figure 1.4, there is a close relation between the two planning levels as they influence the performance of the supply chain. The economic, environmental and social performances are affected directly by the strategic decisions on investments and configuration as well as by the financial variables resulting and carbon footprint from the planning decisions. The planning decisions are constrained by the investment and configuration decisions. For example, the investment in a new technology/machine can change the variable production cost significantly, the level of energy use, GHG emissions and the ergonomic situation for workers.

Sustainable supply chain network design problem (strategic planning) with a single optimal solution is not realistic because usually there is a trade-off to find. In this case, different solutions /alternatives might exist.

Usually, different constraints are commonly considered in classical supply chain design models : conservation of flow, capacity, consistency or linkage constraints. For sustainable

supply chains, some additional constraints are considered in term of energy balance and the level of emissions to the system. Finally, data used in this case is different when compared with classical model. Indeed, an LCA based approach is necessary in order to establish the link between the critical inputs (raw material, energy, human, used product) and the output (GHG emissions, waste). The performance evaluation become more accurate and considers the critical decisions that influence strategic planning.

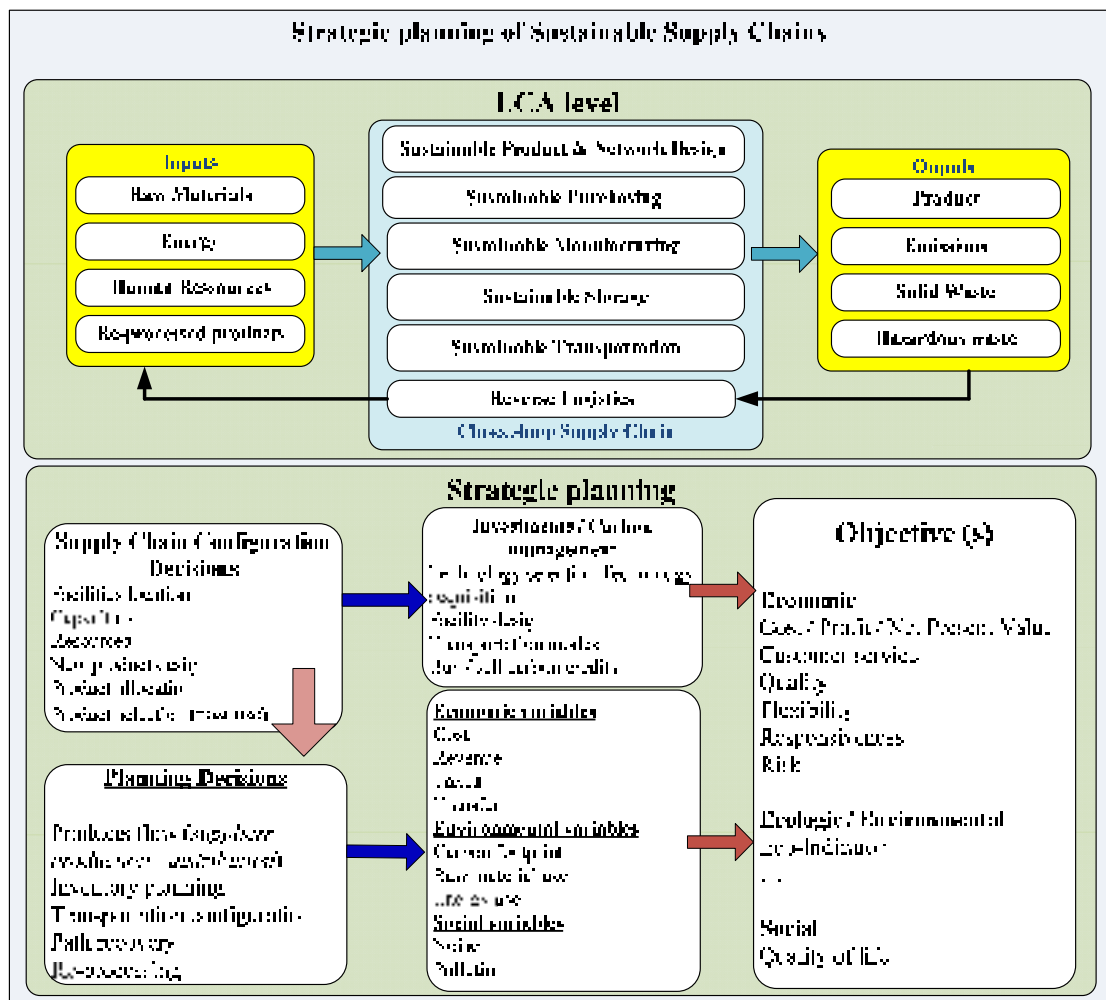

Figure 1.4 An LCA approach to support the planning of sustainable supply chains.

1.5 Conclusion

In this chapter we present a detailed literature review about past and emerging issues related to supply chain management. Sustainable supply chain management is very complex but imposes new challenges for academic and practitioners. Different decision making models and approaches are under development and show that is an active field of research. From an extensive literature review about different aspects of sustainable supply chain practices, we came to the conclusion that an integrated approach that links the LCA methodology with the classical strategic planning models is necessary. The interaction with external mechanism and especially regulations is important.

CHAPTER 2

ARTICLE #1 «A TWO-PHASE MULTI-CRITERIA DECISION SUPPORT SYSTEM FOR SUPPLY CHAIN MANAGEMENT»

Amin Chaabane, Amar Ramudhin, Marc Paquet

Département de génie de la production automatisée, École de Technologie Supérieure,
1100 Notre-Dame Ouest, Montréal, Québec, Canada H3C 1K3

International Journal of Operational Research,

Volume 9, Issue 4, 2010

DOI: 10.1504/IJOR.2010.036287

Résumé

Les méthodes d'analyse multicritères ont été utilisées pour résoudre toute une série de problèmes du monde réel en sciences de gestion et plus spécifiquement dans la gestion des chaînes d'approvisionnement. Les résultats obtenus sont encourageants. Néanmoins, des approches robustes sont encore nécessaires à développer avant qu'un cadre efficace et opérationnel soit mis au point.

Le premier article de cette thèse se focalise sur la dimension économique. On a cherché à apporter une contribution à la gestion de la chaîne d'approvisionnement qui considère plus qu'un objectif pour assurer la durabilité économique. Une approche hiérarchique à deux phases incluant les niveaux de décision stratégique et tactique est introduite. L'évaluation qualitative de la chaîne est faite selon le modèle de référence «Supply Chain Operations Reference» (SCOR). Dans la première phase, l'évaluation de plusieurs configurations de chaînes potentielles est réalisée et le choix est obtenu avec la méthode d'analyse selon le processus hiérarchique (AHP). La deuxième phase résout le problème de positionnement de stocks de sécurité dans le réseau.

Abstract

Multi-criteria decision making techniques have been used to solve a range of real world problems in management science and specific Supply Chain Management (SCM) problems (e.g. supply chain design and reconfiguration, purchasing, scheduling, supplier selection). The results obtained are encouraging. Nevertheless, robust approaches for solving multi-criteria supply chain problems are still in progress, and more research is needed before an effective and operational framework can be developed. The proposed approach introduces a two-phase hierarchical approach to solve a multi-criteria SCM problem integrating both strategic and tactical decisions where the supply chain is evaluated based on the Supply Chain Operations Reference model. The latter considers various metrics such as delivery reliability, flexibility, responsiveness, and cost. The first phase evaluates different supply chains configurations using Analytic Hierarchy Process. The second phase solves the network for the optimal safety stock placement using dynamic programming. The output from this two-phase process is a supply chain network configuration that has the right amount of safety stocks at the right place to absorb variability in demand.

2.1 Introduction

Supply chain management (SCM) has been successfully applied to solve industrial problems for several companies. It enhances the planning and execution of operations, reduces global costs, and improves customer service level. SCM techniques are also heavily used in the aeronautic industry. In this field, the supply chain is described as a complex assembly system which is usually controlled by the enterprise producing the final product. Indeed, this enterprise dictates operation strategies in order to guarantee a competitive advantage for all supply chain members. Also, strategic and tactical decisions are centralized and can be imposed by this final enterprise. The main characteristic is that finished products must be assembled in response to a customer order : there is usually no inventory of final products. In addition, customer demand is unstable and characterized by low production volumes and

high variety in products when compared to automobile industry. Also, final products can take several months to be delivered because of high supply and production lead times.

In this article, we study the problem faced by an aircraft engine manufacturer facing a steep increase in demand, supply shortages, and long production lead times for new products recently introduced in the market. The supply chain is loosely coupled in the sense that suppliers work independently with little collaboration and synchronization. To achieve more stability in supply chain processes from upstream suppliers to downstream customers when introducing new products, it is necessary to identify rapidly the best supply chain that fits better with enterprise strategy, establish good partnerships between supply chain actors to reduce uncertainty, reduce long lead times, increase velocity and visibility of parts in the supply chain, minimize total supply chain costs, and improve other metrics like delivery performance, flexibility, and responsiveness. Inventory planning is a significant issue in SCM (Srikanta et Prasad, 2007), and variability is an important factor that we have to take into account in this context. Protection against variability can be done by placing safety stocks at strategic points. But determining optimal safety stock quantities to store is complex because of the dynamic nature of the system and the interdependencies between all partners that belong to the supply chain (Figure 2.1).

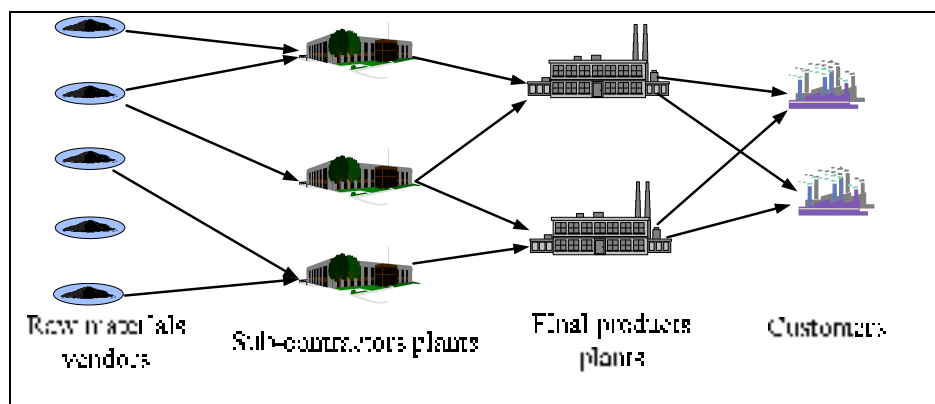

Figure 2.1 Supply chain structure in the aeronautic industry.

To study and solve this problem, we propose a two-phase multi-criteria decision support system that can help supply chain managers to compare rapidly different potential supply

chain networks based on several criteria. The proposed approach includes an algorithm for safety stock analysis in a multi-echelon context with production and transportation lead-times considerations under a periodic review base-stock policy. A preliminary experimentation based on dynamic programming to optimize total safety stock cost is shown.

The article is organized as follows. Section 2 reviews the literature on multi-criteria decision models for supply chain management. Section 3 describes the proposed framework. Section 4 presents the AHP method and explains criteria used for supply chain network selection procedure with a numerical example. Section 5 synthesizes the safety stock optimization model and a solution procedure based on dynamic programming. Finally, a conclusion and future research directions are presented in section 6.

2.2 Literature review

Supply chain management decisions can be classified into three categories : strategic, tactical and operational. Strategic decisions dictate the supply chain configuration. Tactical decisions try to find best ways to serve customers through planning and scheduling. This includes decisions such as which markets will be supplied from which locations and the production and inventory policies enforced at each production location. The operational decisions find ways to expedite customer orders to meet customer's due dates (Chopra et Meindl, 2004). A good review of strategic, tactical and operational decisions making models can be found in Vidal and Goetschalckx (1997) and Bilgen and Ozkarahan (2004). Decision support systems and models that take into account strategic, tactical, and operational decisions simultaneously are infrequent because they are complex and hard to solve. We can classify existing models into two categories : single-criteria/objective models and multi-criteria/objective models. Single-criteria models concentrate on single objective function. The most common of these try to integrate supply chain design with production and distribution decisions.

Dogan and Goetschalckx (1999) develop a mixed integer program and propose a primal decomposition method to integrate production and distribution decisions when designing the supply chain. They perform a case study, and show that the integrated approach saved the

company studied up to 2% of total cost when compared to the hierarchical approach. Jang et al. (2002) propose a supply chain management system that integrates supply chain network design together with production and distribution operations from raw material suppliers to customers. Vila et al. (2007) propose an approach that takes into account market opportunities in a model that integrates network design and production-distribution activities. The model is solved using the sample average approximation method based on Monte Carlo sampling techniques.

Multi-criteria models formulate integrated supply chain decisions problems as a multi-criteria/objective program (Keeney et Raiffa, 1976; Steuer, 1986). Arntzen et al. (1995) introduce a Global Supply Chain Model (GSCM) to design the supply chain and manage complexity in an international context. It was possible to minimize cost or weighted cumulative production and distribution times or both subject to a set of technological constraints. Li and O'Brien (1999) focused on improving supply chain efficiency and effectiveness under four criteria : profit, lead time performance, delivery promptness and waste elimination in a hierarchical way. Min and Melachrinoudis (1999) present a real-world case study involving the re-location of a combined manufacturing and distribution (warehousing) facility. Sabri and Beamon (2000) develop an integrated multi-objective supply chain model for simultaneous strategic and operational planning in supply chain design. Luo et al. (2001) present a mathematical model to design and optimize supply chains in terms of performance indexes such as product cost, cycle time, quality, energy and environmental impact in the context of global and Internet-based manufacturing. A multi-objective optimization model is formulated and solved for a personal computer company. Chen et al. (2003) propose fuzzy decision-making method to achieve a compromise solution among all participant companies of the supply chain. Dotoli et al. (2005, 2006) propose a multi-level approach for network design of integrated supply chains. They introduce a good framework to study integrated decisions making in supply chain design. They define three hierarchical levels (Dotoli et al., 2005). First, performances of candidates to join supply chain are evaluated and efficient elements are selected. The second level solves a multi-criteria mixed integer model to configure the proposed network. The third level evaluates network

performance resulting from the first and second levels. Hugo and Pistikopoulos (2005) presented a mathematical programming-based methodology for the explicit inclusion of life cycle assessment (LCA) criteria as part of the strategic investment decisions related to the design and planning of supply chain networks. Altıparmak et al. (2006) propose a new solution procedure based on genetic algorithm to find the set of Pareto-optimal solutions for multi-objective supply chain network design problem. Finally, Pokharel (2008) propose a two objective model for decision making in a supply chain network design, and show that the supply chain configuration changes when the decision makers' preferences about the two objectives vary.

Multi-criteria models extend traditional single criteria approaches to optimize several objectives simultaneously. Here, there is no optimal solution as we try to find a Pareto-efficient solution based on the decision makers preferences which reflect more the reality of supply chain management problems. The following observations can be made. Single-criteria models are relatively easier to solve as compared to multi-criteria/objective models. They provide optimal solution, and offer possibilities to integrate several constraints. Usually, these models are easier to analyze by decision-makers. Multi-criteria models take into account different criteria : subjective and objective. Since there are usually multiple satisfactory solutions, they offer techniques to analyze and rate each solution.

2.3 Problem statement and proposed approach

2.3.1 Problem statement

In this article, we assume that the enterprise has already identified some potentials supply chain networks able to manufacture the new product based on previous experiences. Strategic and tactical decisions are centralized (Sarmah, 2008), and controlled by the final enterprise to define the competitive strategy of the supply chain. Several performance metrics (quantitative and qualitative) are available and characterize each potential supply chain. The first decision consists of selecting the best network that respects the enterprise strategy. Once this is done, we have to adjust safety stock parameters at each node (suppliers, sub-

contractors and manufacturers) in order to guarantee a fixed customer level for the new product which might be different compared to other products.

2.3.2 The proposed approach

To solve this problem, we propose a new framework that describes a decision support system for supply chain selection and multi-nodes safety stock optimization. We propose to use the Analytic Hierarchy Process technique (AHP) (Saaty, 2001), a well known multi-criteria approach, combined with an optimization mathematical model for safety stock placement decisions. The proposed methodology is based on a hierarchical process with two phases (see Figure 2.2).

The first phase is the Supply Chain Network Selection. At this level, AHP is applied to evaluate several supply chain networks, and finally select the best one. It is important to notice that the different potentials supply chain networks can be generated based on a multi-objective optimization (Chen et Lee, 2004; Chen et al., 2003; Luo et al., 2001b; Sabri et Beamon, 2000). Multiple-criteria and performances metrics are used to measure supply chain network efficiency such as delivery reliability, flexibility, responsiveness, and costs. Decision-makers articulate their preferences, and AHP gives the rank of supply chain networks. The output from this phase is the suitable supply chain network that we have to consider to manufacture the new product. The second phase is for safety stock placement. The main decision here is to determine the amount of safety stock required at each node in order to protect operations from demand variability. Finally, we can proceed to evaluate the solution performance. The proposed hierarchical structure makes possible to evaluate the impact of supply chain network configuration on safety stock placement which is usually ignored in the existent literature.

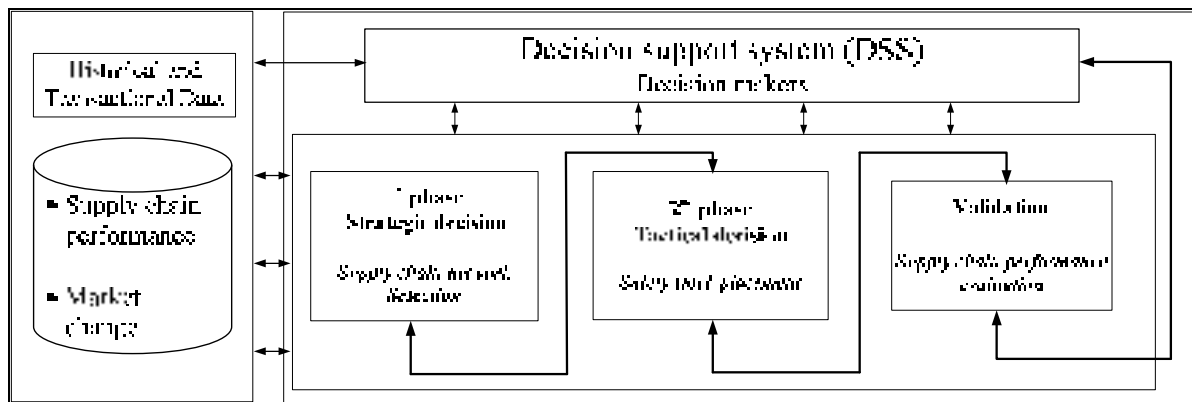

Figure 2.2 Decision support system for multi-criteria supply chain analysis.

2.4 Supply chain network selection phase using AHP

In this section, we introduce AHP and define the different performance metrics used for selecting the suitable supply chain network based on decision-makers preferences. A numerical example is explained and illustrates how to apply this technique for supply chain networks selection.

2.4.1 The Analytic Hierarchy Process (AHP)

A multi-criteria problem arises during phase 1 due to consideration of multiple metrics to measure the supply chain performance. Several well known multi-criteria decision making methodologies can be adopted : e.g. the ELECTRE method (Schärlig, 1996), the Data Envelopment Analysis (DEA) (Ramanathan, 2003), the Analytic Hierarchy Process (AHP) (Saaty, 2001), and PROMETHEE (Beynon, 2008).

The ELECTRE method is based on common sense techniques. However, the main drawback of the methodology is that the resulting candidates ranking depends on the choice of the threshold values, as well as on the number of available alternatives. In fact, when the latter are numerous, taking into account the various performance criteria in the choice of thresholds and weights becomes impractical (Schärlig, 1996). Also, the DEA method does not produce an actual classification of the alternatives : it rather carries out, using the linear programming

technique, an efficiency evaluation, giving as an output the set of efficient actors. In addition, the technique evaluates the level of inefficiency associated with the remaining candidates. The advantage of the AHP method is the possibility for the decision maker to use qualitative decisions based on pair-wise comparisons of the alternatives. Also, the method gives a rank for the different alternatives based on the decision maker's preference, and consequently the best supply chain among them.

Saaty (2001) advised the following steps when applying AHP to study multi-criteria problems. First, the main objective must be identified in step 1. In our case, the goal is to choose the best network from several potential alternatives. In step 2, all criteria that might influence the decision must be specified. In step 3, hierarchy, metrics and contributory factors are defined. In general, this hierarchy contains 3 levels : (i) the focus or the goal (ii) the objective/criteria for achieving the goal, and (iii) the evaluation criteria for deciding the objective. Step 4 consists of estimating the relative priorities (weights) of the decision criteria. So, we construct a set of pair-wise comparison matrices for each of the lower levels with one matrix for each element in the level immediately above by using the relative AHP scale measurement shown in Table 2.1.

Table 2.1
Pair-wise comparison scale for AHP preferences (Saaty, 2001)

Numerical rating	Verbal judgments of preferences
9	Extreme importance
8	Very strong to extreme
7	Very strong importance
6	Strong to very strong
5	Essential or strong importance
4	Moderately to strongly
3	Moderate importance
2	Equally to moderate
1	Equally importance

The pair-wise comparisons are done in terms of which element dominates the other. Saaty used the concept of eigenvector of the comparison matrix to find criteria and contributory factors weights. For each pair-wise comparison matrix \mathbf{A} , by using the theory of eigenvector, i.e. $(\mathbf{A} - \lambda_{\max} \mathbf{I})\mathbf{w} = 0$, we calculate the eigenvalue λ_{\max} and the eigenvector $\mathbf{w} = (w_1, w_2, \dots, w_n)$ where n is the matrix size. Thus, weights of the criteria can be estimated. Step 5 is for testing the consistency of intuitive judgment. Saaty also introduced the consistency index (CI). The consistency is determined by using the following formula : $CI = (\lambda_{\max} - n) / (n - 1)$. Now, judgment consistency can be verified by computing consistency ratio (CR) of CI with the appropriate value of a random index (RI) specified in Table 2.2 : $CR = CI / RI$. The CR is acceptable if it does not exceed the value of 0.1. If it is more than 0.1, the judgment matrix is inconsistent. To obtain a consistent matrix, judgments should be reviewed and improved until $CR \leq 0.1$.

Table 2.2
Random consistency (RI) (Saaty, 2001)

Matrix size (n)	1	2	3	4	5	6	7	8	9	10
Random consistency	0	0	0.58	0.9	1.12	1.24	1.32	1.41	1.45	1.49

Step 6 is for rating alternatives and aggregating the priority value. Alternatives are related to each contributory factor and the hierarchical additive weighting method is used to aggregate the priority and determine the rank of all alternatives (Saaty, 2001).

2.4.2 SCOR Level 1 metrics

Supply chain management is different from managing only one company, and metrics that measure the supply chain performance are much more complex (Craig et Hannes, 2006). The process of selecting the suitable supply chain is difficult. The use of a single performance measure is commonly used in the different modelling approaches due to its simplicity.

Nevertheless, if we consider only one performance measure, for example the cost, the supply chain may be operate under the minimum cost, but it may show poor customer response time and a lack of flexibility to meet a random fluctuations in demand. So, it is important to consider more than a single performance metric to decide on problem related to supply chain management. The Supply Chain Operations Reference model (SCOR) (Supply Chain Council, 2006) presents 13 performance metrics. A company cannot be best in all 13 of the Level 1 metrics, but it should find a trade-off between several in order to be able to evaluate the impact of each metric on strategic, tactical and operational decisions. In practice, it is not easy to consider all of these metrics and most of companies concentrate on some of them. We can aggregate the different metrics into four categories : *supply chain reliability, supply chain flexibility and responsiveness, supply chain costs, and efficiency in managing assets*. A brief description of each metric is given in Appendix.

2.4.3 Supply chain selection based on AHP

To illustrate the first phase for supply chain selection, we assume that the enterprise team management has identified three potential supply chain configurations based on historical data. We assume that SCOR metrics (Supply Chain Council, 2006) are used to evaluate supply chain performances. The hierarchy structure that we consider is shown in Figure 2.3. The first level describes the main objective which is supply chain network selection. The second level shows two categories of criteria : customer-facing attributes and internal-facing attributes. The customer-facing attributes regroup supply chain reliability (DR) and Flexibility and Responsiveness (FR). The internal-facing attributes regroup cost (CT) and assets (AT). And finally we find the supply chain network alternatives to evaluate.

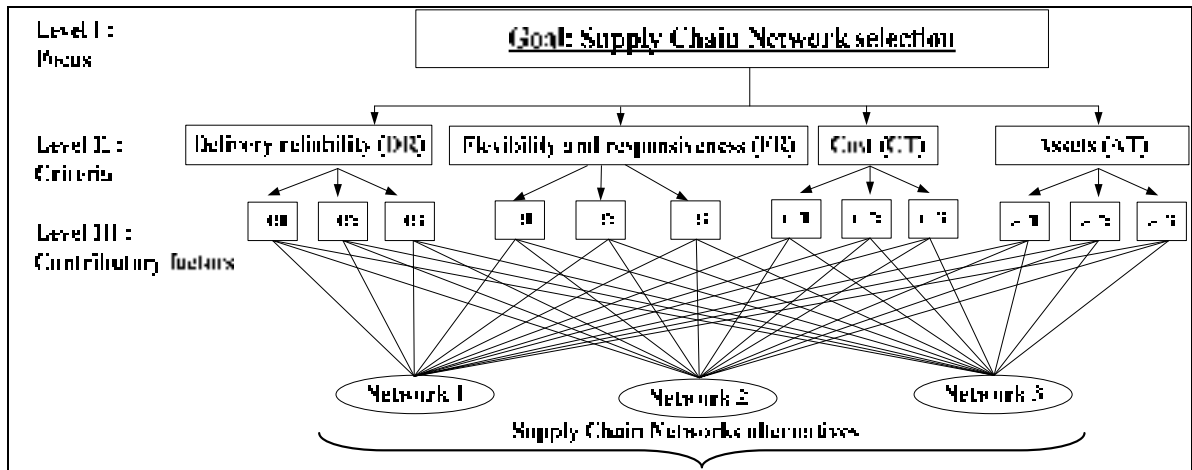

Figure 2.3 Hierarchy for measuring supply chain network performance.

We consider the following data for each network (Table 2.3). It is important to notice that the data available can be estimated from previous experience with other products. The objective is to use these performances to identify which supply chain network to consider for manufacture the new product and respect the enterprise strategy in the absence of detailed and precise information at this level.

Table 2.3
Potential supply chain networks performances

Contributory factors	Network 1	Network 2	Network 3
Delivery reliability (DR)			
DR1 : Delivery performance (%)	60	75	85
DR2 : Fill rate (%)	95	90	50
DR3 : Perfect order fulfilment (%)	80	65	90
Flexibility and Responsiveness FR			
FR1 : Supply chain response time (days)	12	20	15
FR2 : Production Flexibility (days)	80	70	90
FR3 : Order lead time (days)	150	250	200
Costs CT			

CT1 : Total logistic management cost and cost of goods sold (M\$)	2	4	1.5
CT2 : Value-added productivity (K\$)	150	60	100
CT3 : Warranty cost or returns processing cost (K\$)	0.2	0.3	0.1
Assets AT			
AT1 : Cash-to-cash cycle time (days)	130	45	60
AT2 : Inventory days of supply (days)	10	45	16
AT3 : Assets turns (turns)	8	4	1

Expert Choice (Expert Choice Inc, 2000) is used to simplify the implementation of AHP's steps. AHP scale (Table 2.1) is used to perform pair-wise matrix comparison. To transform the available data to AHP scale, we use Table 2.4. The first row shows the possible range of differences in pair-wise comparison. The second row reports the assigned scales. For example, if the difference in performance between two contributory factors is less than 5%, then we choose the AHP scale 1, and this means that the compared alternatives have the same importance relative to the considered factor.

Table 2.4
From pair-wise comparison to AHP scale

	Pair-wise comparison difference (%)								
	[0, 5[[5, 15[[15, 25[[25, 35[[35, 45[[45, 55[[55, 65[[65, 75[[75, 100]
Scale	1	2	3	4	5	6	7	8	9

Decision-makers articulate their preferences about criteria and contributory factors. As results, AHP generates criteria weights, contributor's factors weights and ranking for the three networks. Criteria weights reflect the enterprise strategy.

Table 2.5
Weights and supply chain networks ranked with AHP : Agile strategy

Case 1 : Agile supply chain strategy			
Criteria	Weight	Factors	Weight
DR	0.503	DR 1	0.043
		DR 2	0.318
		DR 3	0.639
FR	0.384	FR 1	0.113
		FR 2	0.179
		FR 3	0.709
CT	0.062	CT 1	0.675
		CT 2	0.068
		CT 3	0.257
AT	0.051	AT 1	0.250
		AT 2	0.681
		AT 3	0.069
		Global weight	Rank
	Network 1	0.388	1
	Network 2	0.245	3
	Network 3	0.367	2

Table 2.6
Criteria weights and supply chain networks ranked with AHP

Case 2 : Lean supply chain strategy			
Criteria	Weight	Factors	Weight
DR	0.074	DR 1	0.043
		DR 2	0.318
		DR 3	0.639
FR	0.063	FR 1	0.345
		FR 2	0.547
		FR 3	0.109
CT	0.609	CT 1	0.675
		CT 2	0.068
		CT 3	0.257
AT	0.254	AT 1	0.250
		AT 2	0.681
		AT 3	0.069
		Global weight	Rank
	Network 1	0.329	2
	Network 2	0.387	1
	Network 3	0.283	3

For this example, we simulate two strategies. For the first strategy (Table 2.5), decision makers give more importance to delivery reliability, flexibility and responsiveness : it is an agile supply chain strategy. In the second case (Table 2.6), decisions-makers give much importance to costs and assets : it is a lean supply chain strategy. In this context, the DELPHI method can be useful to provide a precise value for each criteria weight and with reference to a group of experts in the domain.

With an agile supply chain strategy (Table 2.5), Network 1 is the best one with a global performance equal to **0.388**. However, when we change supply chain strategy from agile to lean (Table 2.6), Network 2 obtains the first rank with a global performance equal to **0.387**. At the end of the process, we select a supply chain network and can proceed to study safety stock placement decisions which is detailed in the next section.

2.5 Safety stock optimization phase

The supply chain configuration is now specified. So, we can proceed to adjust safety stock parameters for the new supply chain (suppliers and sub-contractors) that will fulfill demand of new product. In this section, we assume that we can model the supply chain as a network with different nodes.

Safety stock placement in multi-stage supply chain has been studied by several authors (Graves et Willems, 2000; Humair et Willems, 2006; Inderfurth et Minner, 1998; Magnanti et al., 2006; Minner, 1997; Simchi-Levi et Zhao, 2005). Most modelling approaches are based on Simpson's model for multi-stage serial system (Simpson, 1958). In this preliminary work, we adopt the same approach to derive the safety stock placement model with an additional consideration of transportation lead times in the system.

2.5.1 Basic assumptions and notations

Let consider a final product with a specific bill of materials (BOM). Under the assumption that each component is supplied by only one supplier, the supply chain can be seen as a convergent system with one node for each part or item in the BOM. Every node has only one successor but several predecessors. We index nodes in the following manner : node N represents the downstream level near final customer, and node 1 is the upstream node near the first supplier considered as external to the supply chain. Items for external supplier are always available (without limit).

We assume that there is only one stock point for output products at each supplier, sub-contractors and manufacturers nodes. Transportation is modelled by links between two consecutive nodes, and is characterized by a transportation lead time. Each node operates according to a *periodic review base-stock policy*. At each period, a node observes the demand and places a replenishment order to suppliers equal to the observed demand. There are no capacity constraints. There is a common underlying review period for all nodes.

Demand for final product is stochastic with mean demand μ_N and a standard deviation σ_N . We consider that demand is normally distributed. Each node has a deterministic processing time. It includes all internal operations : waiting time, manufacturing time and material handling time to put the item in the node stock point. Let P_i be the processing time at each node $i = 1 \dots N$ and let t_{ji} be the transit (transport) time between nodes j and i . Let a_{iN} be the unit number of component i necessary to produce one unit of item N . For each node i , let $Pred(i)$ be the subset of suppliers where whom components are sourced (see Figure 2.4). For each node $j \in Pred(i)$, we define S_j as the lead time necessary to obtain component in stock point j ready to be shipped to node i (also called service time (Simpson, 1958)). Let L_i be the necessary lead time for product at node i to be manufactured and stored. L_i is given by the following formula :

$$L_i = P_i + \text{Max}_{j \in Pred(i)} \{t_{ji} + S_j\} \quad (2.1)$$

Let C_i be the net replenishment lead time which is equal to $C_i = L_i - S_i$. C_i is the net lead time that we have to cover by safety stock in order to protect stock point i from shortages caused by demand variability. The safety stock level at stock point i , SS_i , is obtained by the following formula :

$$\begin{aligned} SS_i &= Z_{1-\alpha_i} \sigma_i \sqrt{C_i} \\ &= Z_{1-\alpha_i} a_{iN} \sigma_N \sqrt{P_i + \text{Max}_{j \in Pred(i)} \{t_{ji} + S_j\} - S_i} \end{aligned} \quad (2.2)$$

where α_i is the probability to be out of stock and consequently a delay from committed due date. To this service level, we associate a service factor, $Z_{1-\alpha_i}$, the constant corresponding to the service level enforced at node i .

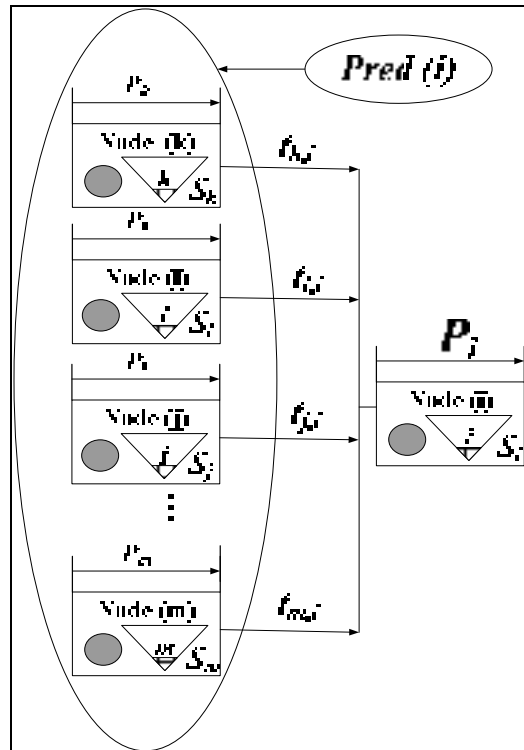

Figure 2.4 Replenishment lead time characterization.

Safety stock computation depends on two endogenous factors : service level and lead time (time between the moment of placing an order and the moment that the product will be available to delivery to the customer). The first factor (service level) is usually defined by the enterprise management team, whereas the second factor (lead time) depends on production strategy and technology. The other exogenous factor is demand variability which reflects market changes.

Table 2.7
Safety level and safety factor

Safety level	90%	91%	92%	93%	94%	95%	96%	97%	98%	99%
Safety factor	1.29	1.34	1.41	1.48	1.56	1.65	1.75	1.88	2.05	2.33

2.5.2 Model formulation : safety stock cost optimization

Let's consider h_i the unit inventory cost for component i . So, we can define the total safety stock cost (CT) for the assembly supply chain by equation 3 :

$$\begin{aligned}
 CT &= \sum_{i=1}^N h_i SS_i \\
 &= \sum_{i=1}^N h_i Z_{1-\alpha_i} a_{iN} \sigma_N \sqrt{\text{Max}_{j \in \text{Pred}(i)} \{t_{ji} + S_j\} + P_i - S_i}
 \end{aligned} \tag{2.3}$$

In an optimization context, the lead time S_i are considered decision variables, and the optimization procedure has to find the best value for each node under only one and important constraint, $0 \leq S_i \leq P_i + \text{Max}_{j \in \text{Pred}(i)} \{t_{ji} + S_j\}$. We assume that S_i is defined as a number of days (or shifts). So, the optimization model is as follows :

$$\begin{aligned}
 \text{Min } CT &= \sum_{i=1}^N h_i SS_i = \sum_{i=1}^N h_i Z_{1-\alpha_i} a_{iN} \sigma_N \sqrt{\text{Max}_{j \in \text{Pred}(i)} \{t_{ji} + S_j\} + P_i - S_i} \\
 \text{s.t. } &0 \leq S_i \leq P_i + \text{Max}_{j \in \text{Pred}(i)} \{t_{ji} + S_j\}, \quad i = 1, 2, \dots, N \\
 &S_i \text{ integer}
 \end{aligned} \tag{2.4}$$

Each node in the supply chain operates according to periodic review base-stock policy. When we specify S_i values, operation policy at each node is specified. For example, when $S_i = 0$, node i promises zero lead-time for successor node; it is a make-to-stock policy in this case.

So, the basic idea within this model is to find the best policy at each node in order to minimize the total safety stock. Thus, we will be able to quantify necessary safety stock for each node to guarantee a defined customer service level.

2.5.3 Dynamic programming formulation

The optimization model obtained in the previous section is non-linear. We propose to use dynamic programming formulation to solve the optimization problem. Let $\beta_i = h_i Z_{1-\alpha_i} a_{iN} \sigma_N$. Let $CT_i^*(S)$ be the minimum cumulative safety stock cost-to-go function at node i and all upstream nodes to node i given that node i quotes a service time equal to S . The recursive procedure is as follows :

Procedure Safety stock recursive function	
for $i = 1$ to N	evaluate M_i (M_i is the maximum possible lead time to obtain components at node i)
for $S = 0$ to $M_i + P_i$	$CT_i^*(S) = \underset{\substack{0 \leq x_{ji} \leq M_i + P_i \text{ and} \\ \text{Max}\{0, S - P_i\} \leq \text{Max}_{j \in \text{Pred}(i)} \{x_{ji} + t_{ji}\}}}{\text{Min}} \left\{ \underbrace{\sum_{j \in \text{Pred}(i)} CT_j^*(x_{ji}) +}_{(1)} \underbrace{\beta_i \sqrt{\text{Max}_{j \in \text{Pred}(i)} \{x_{ji} + t_{ji}\} + P_i - S}}_{(2)} \right\}$
end for	
end for	

In the recursive function, term (1) represents the cumulative safety inventory cost until node i . The term (2) represents safety inventory cost incurred at node i . For each node i , the program find over all feasible values of incoming service times from suppliers ($\text{Pred}(i)$) ($0 \leq x_{ji} \leq M_i + P_i$ and $\text{Max}\{0, S - P_i\} \leq \text{Max}_{j \in \text{Pred}(i)} \{x_{ji} + t_{ji}\}$), and finds the minimum cumulative safety stock cost. The cost-to-go function of node i has to be evaluated for all feasible choices of S , $S \in \{1, 2, \dots, M_i + P_i\}$. To identify an optimal solution, we have to specify the service time

that node N quotes to the final customer. Also, we can assume that the incoming service time at nodes that have not any predecessor is equal to zero. Therefore, we can retrace the network to produce the optimal service time for each node and consequently determine the amount of safety stock in order to minimize total safety inventory cost.

2.5.4 A numerical example

The following example (see Figure 2.5) is used to illustrate the results of safety stock optimization under different service levels for the assembly supply chain composed of six (6) nodes. The data used here are modified from original information for confidential reasons. End item demand is normally distributed with $\mu_6 = 40$ and $\sigma_6 = 5$. Processing times are $P_i = 2$ for $i=1, 3, 5$; $P_2 = 1$; $P_4 = 3$ and $P_6 = 4$. Unit inventory cost parameters are given by $h_i = 100\$$ for $i=1, 2, 3$; $h_4 = 300\$$, $h_5 = 200\$$ and $h_6 = 600\$$. All input coefficients are equal to one ($a_{i6} = 1, i=1, \dots, 5$). Transportation lead times between nodes are also considered equal to one.

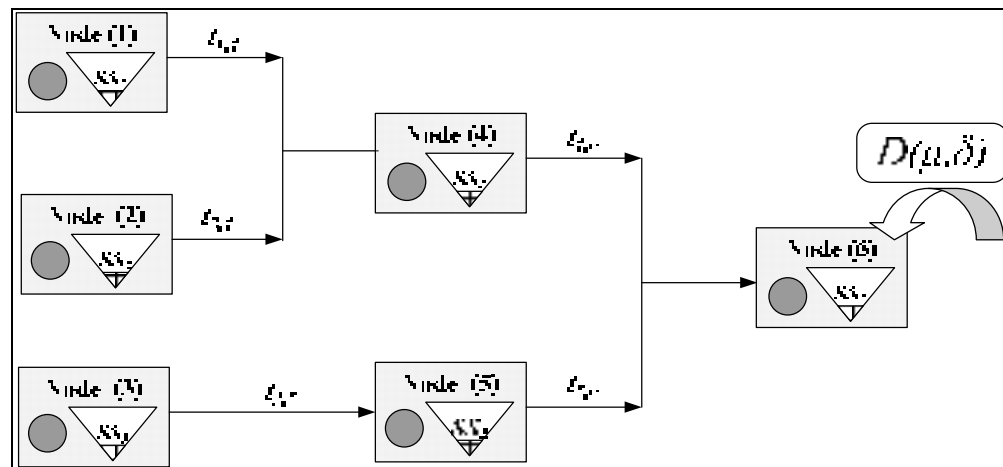

Figure 2.5 Assembly supply chain.

Table 2.8 and Figure 2.6 summarize the optimal safety stock cost for the assembly supply chain with different target service levels and different lead times that can be proposed to final customers ($S_6 = 2, 5, 9$). For a fixed service level, node 6 can propose different lead times which reflect the supply chain strategy. If the lead time is low, it is a responsive supply chain. If the lead time is high, it is an effective supply chain (minimize safety stock cost).

Table 2.8
Safety stock cost for different service level policies

Service Level	Total Safety Stock Cost		
	$S_6 = 9$	$S_6 = 5$	$S_6 = 2$
50%	0 \$	0 \$	0 \$
55%	215 \$	743 \$	1 129 \$
60%	432 \$	1 497 \$	2 276 \$
65%	658 \$	2 277 \$	3 462 \$
70%	895 \$	3 099 \$	4 712 \$
75%	1 151 \$	3 986 \$	6 060 \$
80%	1 437 \$	4 974 \$	7 562 \$
85%	1 769 \$	6 126 \$	9 313 \$
90%	2 188 \$	7 574 \$	11 515 \$
95%	2 808 \$	9 722 \$	14 779 \$
98%	3 506 \$	12 138 \$	18 454 \$

For each value of the service level, the safety stock placement and the cost will change. If the supply chain needs to propose a low lead time to be competitive in the market, supply chain partners have to invest on safety stock to succeed. Also, the total safety stock cost increases as the target service level increases. Finally, to place safety stock within the supply chain, two key parameters must be defined : the target service level and the lead time to the end customer.

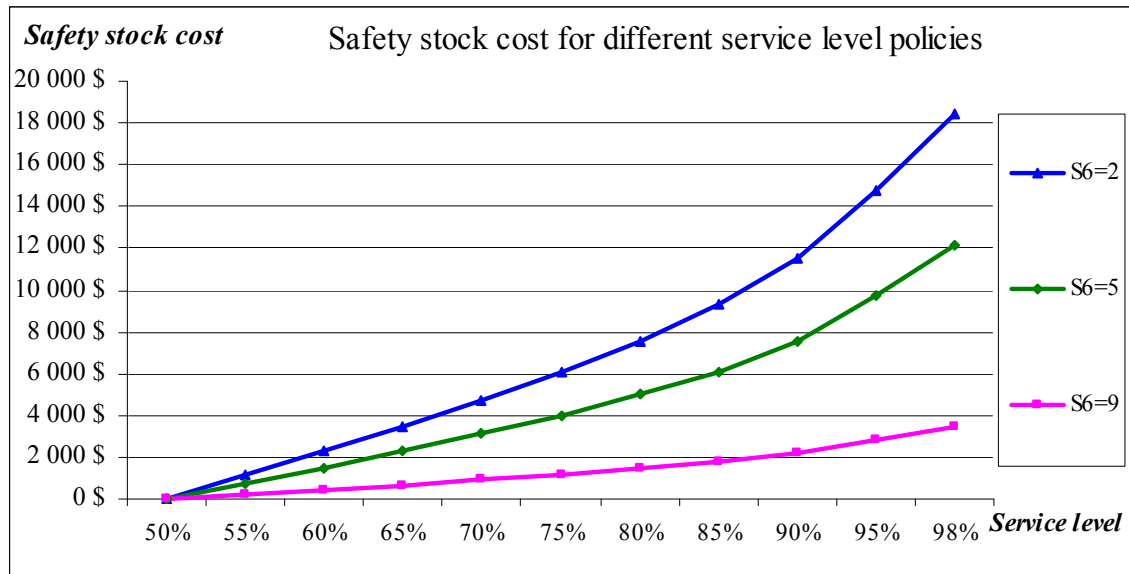

Figure 2.6 Safety stock cost for different service level policies.

2.6 Conclusion and future research

Popularity and application of multi-criteria approaches to a large range of real world problems have been produced encouraging results. However, research into multi-criteria approach for SCM is still in its infancy. In this article, we presented a multi-criteria approach that can help managers to select the right supply chain configuration based on SCOR metrics. A decision support system with two phases is proposed. During the first phase, AHP selects the suitable supply chain based on decision making preferences. This methodology demonstrates that the supply chain configuration can be affected by several factors. Nevertheless, the main challenge here is how to fix criteria weight which can be a difficult task in some cases. The second phase consists of safety stock positioning within the supply chain. A dynamic programming formulation solves the model to optimality. The assumption under which each component is supplied by only one supplier is restrictive especially in a practical context. So, it is important to explore the impact on the solution procedure of considering different suppliers for each component, and different transportation modes.

The proposed framework supposes that the supply chain design process has been already done, and we have only some potential supply chain configurations to choose. In fact, there is

dissociation between the supply chain design phase and safety stock optimization. To extend this approach and obtain a global optimization, a multi-objective optimization model for supply chain network design problem while incorporating safety stock placement decisions might give better interaction between both strategic and tactical decisions, and this will be subject to future research.

Moreover, given the importance of green/ sustainable aspects of the supply chain, it is necessary to take into account of some additional environmental and social criteria at the selection phase using AHP. Also, it is better to include these criteria at the design phase to consider the most important strategic decisions that influence the economic, environmental and social performance of the supply chain.

2.7 References

- Altıparmak, F., Gen, M., Lin, L. and Paksoy, T. (2006) A genetic algorithm approach for multi-objective optimization of supply chain networks. *Computational Intelligence and Information Technology : Applications to Industrial Engineering, Computers and Industrial Engineering*, 51, 196-215.
- Arntzen, B. C., Brown, G. G., Harrison, T. P. and Trafton, L. L. (1995) Global supply chain management at Digital Equipment Corporation. *Interfaces*, 25, 69-93.
- Beynon, M. J. (2008) Constellation graphs and the role of rank position criteria value frontiers in PROMETHEE analysis. *International Journal of Operational Research*, 3, 201-218.
- Bilgen, B. and Ozkarahan, I. (2004) Strategic tactical and operational production-distribution models : a review. *International Journal of Technology Management*, 28, 151-71.
- Chen, C.-L. and Lee, W.-C. (2004) Multi-objective optimization of multi-echelon supply chain networks with uncertain product demands and prices. *Computers and Chemical Engineering*, 28, 1131-1144.
- Chen, C.-L., Wang, B.-W. and Lee, W.-C. (2003) Multiobjective optimization for a multienterprise supply chain network. *Industrial and Engineering Chemistry Research*, 42, 1879-1889.

- Chopra, S. and Meindl, P. (2004) Supply chain management : strategy, planning, and operation, Upper Saddle River, N.J., Prentice Hall.
- Craig, S. and Hannes, G. (2006) Measuring supply chain performance : current research and future directions. *International Journal of Productivity and Performance Management*, 55, 242-258.
- Dogan, K. and Goetschalckx, M. (1999) Primal decomposition method for the integrated design of multi-period production-distribution systems. *IIE Transactions (Institute of Industrial Engineers)*, 31, 1027-1036.
- Dotoli, M., Fanti, M. P., Meloni, C. and Zhou, M. C. (2005) A multi-level approach for network design of integrated supply chains. *International Journal of Production Research*, 43, 4267-4287.
- Dotoli, M., Fanti, M. P., Meloni, C. and Zhou, M. C. (2006) Design and optimization of integrated e-supply chain for agile and environmentally conscious manufacturing. *IEEE Transactions on Systems, Man, and Cybernetics Part A :Systems and Humans*, 36, 62-75.
- Expert Choice Inc (2000) Expert Choice Software 2000. <http://www.expertchoice.com/>.
- Graves, S. C. and Willems, S. P. (2000) Optimizing Strategic Safety Stock Placement in Supply Chains. *Manufacturing and Service Operations Management*, 2, 68-83.
- Hugo, A. and Pistikopoulos, E. N. (2005) Environmentally conscious long-range planning and design of supply chain networks. *Journal of Cleaner Production Recent advances in industrial process optimisation*, 13, 1471-1491.
- Humair, S. and Willems, S. P. (2006) Optimizing strategic safety stock placement in supply chains with clusters of commonality. *Operations Research*, 54, 725-742.
- Inderfurth, K. and Minner, S. (1998) Safety stocks in multi-stage inventory systems under different service measures. *European Journal of Operational Research*, 106, 57-73.
- Jang, Y.-J., Jang, S.-Y., Chang, B.-M. and Park, J. (2002) A combined model of network design and production/distribution planning for a supply network. *Computers and Industrial Engineering*, 43, 263-281.
- Keeney, R. L. and Raiffa, H. (1976) Decisions with multiple objectives preferences and value tradeoffs, New York, J. Wiley.

- Li, D, et O'Brien, C. 1999. 'Integrated decision modelling of supply chain efficiency'. *International Journal of Production Economics*, vol. 59, no 1-3, p. 147-157.
- Luo, Y., Zhou, M. and Caudill, R. J. (2001) An integrated E-supply chain model for agile and environmentally conscious manufacturing. *IEEE/ASME Transactions on Mechatronics*, 6, 377-386.
- Magnanti, T. L., Shen, Z.-J. M., Shu, J., Simchi-Levi, D. and Teo, C.-P. (2006) Inventory placement in acyclic supply chain networks. *Operations Research Letters*, 34, 228-238.
- Min, H. and Melachrinoudis, E. (1999) The relocation of a hybrid manufacturing/distribution facility from supply chain perspectives : a case study. *Omega*, 27, 75-85.
- Minner, S. (1997) Dynamic programming algorithms for multi-stage safety stock optimization. *OR Spektrum*, 19, 261-72.
- Pokharel, S. (2008) A two objective model for decision making in a supply chain. *International Journal of Production Economics Special Section on Sustainable Supply Chain*, 111, 378-388.
- Ramanathan, R. (2003) An introduction to data envelopment analysis : a tool for performance measurement, New Delhi, Sage Publications.
- Saaty, T. L. (2001) Decision making for leaders : the analytic hierarchy process for decisions in a complex world, Pittsburgh, PA, RWS Publications.
- Sabri, E. H. and Beamon, B. M. (2000) A multi-objective approach to simultaneous strategic and operational planning in supply chain design. *Omega*, 28, 581-98.
- Sarmah, S. P. (2008) Supply chain coordination with target profit. *International Journal of Operational Research*, 3, 140 - 153.
- Schärlig, A. (1996) *Pratiquer Electre et Prométhée : un complément à Décider sur plusieurs critères*, Lausanne, Suisse, Presses polytechniques et universitaires romandes.
- Simchi-Levi, D. and Zhao, Y. (2005) Safety stock positioning in supply chains with stochastic lead times. *Manufacturing and Service Operations Management*, 7, 295-318.
- Simpson, J., K.F. (1958) In-process inventories. *Operations Research*, 6, 863-873.

- Srikanta, R. and Prasad, S. (2007) Inventory planning for a multi-echelon supply chain. *International Journal of Operational Research*, 2, 269-283.
- Steuer, R. E. (1986) Multiple criteria optimization theory, computation, and application, New York ; Toronto, J. Wiley.
- Supply Chain Council (2006) SCOR Model Overview ,Version 8.0. Supply Chain Council Inc.
- Vidal, C. J. and Goetschalckx, M. (1997) Strategic production-distribution models : a critical review with emphasis on global supply chain models. *European Journal of Operational Research*, 98, 1-18.
- Vila, D., Martel, A. and Beauregard, R. (2007) Taking market forces into account in the design of production-distribution networks : A positioning by anticipation approach. *Journal of Industrial and Management Optimization*, 3, 29–50.

2.8 Appendix SCOR level 1 metrics (Supply Chain Council, 2006)

Metric category	Level 1 metric	Brief description
Supply chain reliability (DR)	Delivery performance (DR1)	Percentage of orders delivered on time with respect to the total number of orders delivered
	Fill rate (DR2)	Fill rate is percentage of ship-from-stock orders shipped within 24 h of order receipt
	Perfect order fulfillment (DR3)	The percentage of orders meeting deliver performance and with complete and accurate documentation with no shipping damage
Flexibility and responsiveness (FR)	Supply chain response time (FR1)	The time it takes the integrated supply chain to respond to abnormal (significant) change in demand
	Production flexibility (FR2)	Production flexibility can be seen in two parts, upside flexibility and downside flexibility
	Order fulfilment lead time (FR3)	The average actual lead time consistently achieved from customer authorization of purchase order to final installation/order completion at customer end.
Cost (CT)	Total logistics management cost (CT1)	The sum of supply chain related costs for order management, material acquisition, inventory carrying, finance and planning
	Cost of goods sold (CT1)	The cost associated with buying raw materials and producing finished goods.
	Value added productivity (CT2)	It includes materials, labour, and problem diagnosis for product defects
	Warranty cost or returns processing cost (CT3)	It includes materials, labour, and problem diagnosis for product defects
Assets (AT)	Cash-to-Cash cycle time (AT1)	Cash-to-Cash cycle time is a measure of the time required in days to convert cash paid to suppliers into cash received from customers, including the inventory required.
	Inventory days of supply (AT2)	Total gross value of inventory at standard cost before reserves for excess and obsolescence.
	Asset turns (AT3)	Total turns of capital employed. It impacts inventory, accounts payable, accounts receivable, and fixed assets on the balance sheet.

CHAPTER 3

ARTICLE #2 «DESIGNING AND EVALUATING SUSTAINABLE SUPPLY CHAINS»

Amin Chaabane, Amar Ramudhin, Marc Paquet

Département de génie de la production automatisée, École de Technologie Supérieure,
1100 Notre-Dame Ouest, Montréal, Québec, Canada H3C 1K3

Accepted for publication in Production Planning and Control journal.

Résumé

La croissance de la sensibilisation aux responsabilités sociales des entreprises et les réglementations sur les émissions de carbone ainsi que les déchets obligent les entreprises à concevoir des chaînes d'approvisionnement durables. En outre, le marché de carbone introduit une nouvelle complexité.

Cet article présente une méthodologie pour étudier la problématique de conception de chaîne d'approvisionnement durable en considérant la dimension économique qui inclut l'ensemble des coûts logistiques y compris la sélection des fournisseurs et des sous-traitants, l'acquisition de technologies, et le choix des modes de transport et la dimension environnementale mesurée par les émissions de carbone.

La méthodologie proposée fournit aux décideurs un modèle de programmation mathématique linéaire en nombres entiers et multi-objectif pour comprendre le compromis entre les coûts logistiques et la réduction du carbone. L'approche est illustrée par un cas d'étude de l'industrie sidérurgique qui fait face à une nouvelle réglementation sur les émissions de carbone. Les résultats montrent que l'interaction avec le marché du carbone permet de réduire le coût de réduction de dioxyde de carbone. En outre, cette recherche montre que, en raison de la dynamique des prix sur le marché du carbone, il est important d'envisager un modèle multi-période de la planification stratégique des chaînes d'approvisionnement durable.

Abstract

Increasing awareness of social responsibilities and regulatory legislation for carbon and waste management are forcing enterprises to design viable supply chains with respect to economic, social and environmental objectives. Furthermore, cap and trade legislation for greenhouse gases emissions introduces a new complexity. This paper presents a comprehensive methodology to address sustainable supply chain design problems where carbon emissions (environmental dimension) and total logistics costs, including suppliers and sub-contractors selection, technology acquisition, and the choice of transportation modes (economic dimension), are considered in the design phase. The proposed methodology provides decision makers with a multi-objective mixed-integer linear programming (MILP) model to understand the trade-off between total logistics costs and carbon reduction. The approach is illustrated through a study of a Canadian operating in the steel industry and is facing new regulatory legislation that caps carbon emissions. The results show that the interaction with the carbon trading market reduces the carbon dioxide abatement cost. Moreover, this research shows that due to the dynamic price of the carbon market place, it is important to consider a multi-period model for the strategic planning of sustainable supply chains.

3.1 Introduction

Sulphur dioxide caps for electric utilities in the United States, regulatory carbon dioxide caps for companies across the European Union, and domestic regulatory framework for greenhouse gases (GHG) emissions reduction in Canada and Australia, are only a few of the numerous regulations on air emissions that exist today. Corporations are realizing that sustainability policies are bottom-line issues. Aberdeen Group argues through a survey of 300 firms, worldwide, that Corporate Social Responsibility (CSR) and Sustainable Supply Chain Management (SSCM) are on the top of the “green agenda” (Nari et al., 2008). Also, the benchmark demonstrates that 50% of them are planning to redesign their supply chain to be more sustainable. Finally, the study shows that almost 80% of them have to be in compliance with new environmental regulations.

As a consequence, corporations face new realities and need to evaluate several potential options and mechanisms to meet their legal obligations. Ideally, they should reduce carbon emissions through sustainable actions such as the implementation of energy efficiency measures, the deployment of carbon capture and storage systems, or investing in other emissions reduction strategies and green technologies. Alternatively, companies can have access to other compliance mechanisms to earn carbon credits with the contribution to climate change technology fund or through Emission Trading Systems (ETS) and carbon trading (Peace and Juliani, 2009). The carbon trading markets were introduced under the Kyoto Protocol, known as the United Nations Framework Convention on Climate Change (UNFCCC), as a worldwide effort to reduce emissions of GHG. Thus, with the emergence of a price on GHG emissions, what previously could be emitted with no economic consequence could now be bought or sold with those making the biggest reduction in GHG standing to gain the highest monetary value.

Emission Trading Scheme (ETS) is centred on *credits* which represent the right to emit a given quantity of GHG during a given period. Credits are established by the government through environmental regulation and they are denominated at 1-tonne of CO₂ equivalent, expressed as *tCO₂e*. A company holding one allowance for a specified period may emit 1 tCO₂e during this period. Also, ETS is based on a “Cap-and-Trade” approach where GHG emissions cap is enforced. Companies that reduce GHG emissions below the cap would be allocated tradable carbon credits. Those corporations exceeding the cap need to acquire an equivalent amount of credits to meet the regulatory obligation or stand to pay a penalty. There is already a number of active carbon markets for GHG emissions such as the European Union Emission Trading Scheme (or EU ETS) in Europe, the largest multi-national GHG emissions trading scheme in the world, the New Zealand Emissions Trading Scheme (NZ ETS) in New Zealand, the Chicago Climate Exchange in United State (Peace and Juliani, 2009, Johnson and Heinen, 2004), and more recently the Montreal Climate Exchange in Canada (MCeX).

The theory of a “cap-and-trade” emissions reduction system is extremely simple : it is a choice between “make or buy”. Companies with a cap will comply by either reducing their

emissions through changes in their supply chain (make GHG reduction) or buying carbon credits from the market or from someone who has carbon credits. Each tonne reduction below the cap level give rise to a credit which can also be then traded in the carbon market (Labatt and White, 2007). Choosing between make or buy is complex because of the many options and places available at all stages of the supply chain for carbon reduction such as changes in product design, alternative manufacturing options, various transportation modes and options, and the use of reverse logistics options (recycle, reuse, etc.), and the price of the various options. A comprehensive decision making methodology that integrates the various choices as well as the consideration of emissions trading in order to achieve GHG reduction targets in a cost effective manner is necessary and would be very useful for supply chain managers to design and evaluates sustainable supply chains.

This paper extends the methodology for designing carbon market sensitive and green supply chains that was first introduced in (Ramudhin et al., 2008). First, the problem is described and the literature reviewed in section 2. The solution methodology is detailed in section 3. Section 4 introduce a multi-objective mixed integer model to support decision makers in the generation of different supply chain configurations and the evaluation of their performances with respect to the economic and environmental constraints. Emphasis is placed on the use of environmental data and the carbon trading systems. Section 5 shows a detailed solution methodology and the different steps to follow. In section 6, the approach is illustrated through a case study of a well known Canadian firm which operates in the steel industry and is facing new regulatory legislations that cap carbon emissions. Section 7 concludes and discusses future research directions.

3.2 Problem description and literature review

The government of Canada committed to develop and implement a long term plan for GHG emissions and air pollution reduction. The regulatory framework established targets of reduction of GHG emissions for different industrial sectors (Government of Canada, 2008), such as electricity generation, oil and gas, pulp and paper, iron and steel, etc. Thus, each

corporation touched by this regulation has an immediate need to reduce GHG emissions and they would like to do this efficiently and in as cost-effective manner.

To provide compliance and minimize the economic impact of the regulation, several options are available. First, firms can reduce their own emissions through abatement actions. Also, they can contribute to a technology fund, which would then act as a means of promoting the development, deployment, and diffusion of technologies that reduce emissions of GHG. In addition, they can use emission trading, including inter-firms trading, emissions reduction credits from non regulated activities, and certain credits from the Kyoto Protocol's Clean Development Mechanism. Finally, the use of one-time recognition of early action between 1992 and 2006 to reduce GHG is also considered (Government of Canada, 2008). Thus, companies across the country are struggling to find the best strategic decisions in order to maintain an efficient and sustainable supply chain under the environmental regulations and the carbon market (Peace and Juliani, 2009).

The integration of sustainability considerations is a key issue. Sustainable Supply Chain Network Design (S-SCND) recognizes that long-term competitive advantage should be achieved through the alignment of economic, social and environmental goals (Frota Neto et al., 2008). The objective of economic sustainability is to minimize the total logistic cost or maximize the profit of different supply chain activities through product life cycle stages : purchasing, production, warehousing, distribution and recycling. Environmental supply chain sustainability means that permanent environmental damages should be avoided. Energy should be used efficiently; waste (liquid and solid) should be treated and air pollution reduced through the use of cleaner energies or other technologies. As for social sustainability, the objective is to improve the quality of life of the communities in which the supply chain operates through various initiatives such as funding special projects (school, hospital, etc), noise reduction and community services.

There are a number of approaches that strive to address different aspects of sustainable supply chain management. Recent papers (Srivastava, 2007, Seuring and Muller, 2008) present a review of several elements related to supply chain sustainability : green design

(Pistikopoulos and Hugo, 2005), inventory management (Ferretti et al., 2007), production planning and control for remanufacturing (Luo et al., 2001), green manufacturing (Ferretti et al., 2007), product recovery (Jayaraman et al., 1999), reverse logistics (Sheu et al., 2005), waste management (Ferretti et al., 2007), energy use (Dotoli et al., 2005) and GHG emissions reduction (Ferretti et al., 2007). It is not surprising to see that mathematical modelling based methodologies are the most commonly used. Indeed, these models can be embedded in decision support systems to test the efficiency of various supply chain configurations and operating strategies. A variety of optimization techniques such as multi-criteria mathematical models, dynamic programming, non-linear programming and Markov chains have been used to tackle these problems. The literature suggests that sustainable supply chain practices require the integration of different decisions at different levels (strategic, tactical, and operational) while considering the balance (trade-offs) between some key performance indicators (Ferretti et al., 2007, Guillen-Gosalbez and Grossmann, 2009). These performances are usually conflicting and need advanced optimization techniques to find the best trade-off. Multi-Objective Optimization (MOO), a well established area within the field of operational research (Cohon, 1978), is particularly suited for this type of problems.

Examples of supply chain studies with the incorporation of environmental costs are limited for now in the literature but are critical because of the rising cost of carbon emissions. Carbon emissions' trading has been steadily increasing in recent years. According to the World Bank's Carbon Finance Unit, 374 million metric tons of carbon dioxide equivalent (tCO₂e) were exchanged through projects in 2005, a 240% increase relative to 2004 (110 m tCO₂e) which was itself a 41% increase relative to 2003 (78 mtCO₂e). In terms of dollars, the World Bank has estimated that the size of the carbon market as follows : 11 billion USD in 2005, 30 billion USD in 2006, and 64 billion in 2007 (Karan and Philippe, 2008). As evidence, the carbon price in the European Union Emission Trading Scheme (EU ETS) reached 25 € in 2008. Moreover, the Montreal Climate Exchange (MCeX) has been launched in May 2008, and the regulatory framework considers emissions trading as one of the important measures available for industries to face up to the issue of GHG reduction.

Although the prices are very volatile right now, they are estimated to reach \$100 by 2020 (Government of Canada, 2008).

Thus, the main contribution of this work is a methodology that incorporates regulatory environmental constraints and the “cap and trade system” together with the traditional economic performance in supply chain, including suppliers and sub-contractors selection, technology acquisition and transportation modes configuration. This approach uses a mixed integer linear programming (MILP) model that facilitates strategic decision-making and provides a better understanding how the supply chain would react to various forms and combinations of environmental regulations and technological advances.

3.3 Solution methodology

Traditionally, supply chain network design methodologies attempt to establish the best supply chain configuration that maximizes the long-term economic performance. The decisions cover strategic planning of : product design, sourcing and subcontracting choice, technology selection and production strategies, storage mechanisms, transportation system configuration, and the integration of reverse logistics activities. Here, we refer to these decisions by the “internal strategic mechanisms” available to supply chains managers in order to achieve the economic performance (see Figure 3.1). For a long time, the environmental impact of the supply chain network was ignored at the design phase and lead to different environmental problems (climate change and global warming). In many countries, different regulations (e.g. Kyoto Protocol) have been introduced and impose the monitoring and the inventory of GHG emissions of supply chain activities for different industrial sectors.

In this research, the methodology considers environmental regulations in the form of GHG emissions limits (caps). Thus, the supply chain performance is evaluated based not only on the economic performance but also on the environmental performance measured by GHG emissions. To be in compliance with the regulation, we allow a wider choice of options and operating strategies (Internal Strategic Mechanisms). Moreover, carbon trading mechanisms

are available for consideration and they are considered as the external mechanisms available to be in compliance with the regulation. Thus, the sustainable supply chain network design problem is formulated as a multi-objective mixed integer linear optimization program to decide on the supply chain configuration. The solution methodology evaluates the economic operating costs together with the resulting GHG emissions and finds the best supply chain configuration that minimizes the total logistics costs and GHG emissions with an interaction with carbon market place (see Figure 3.1).

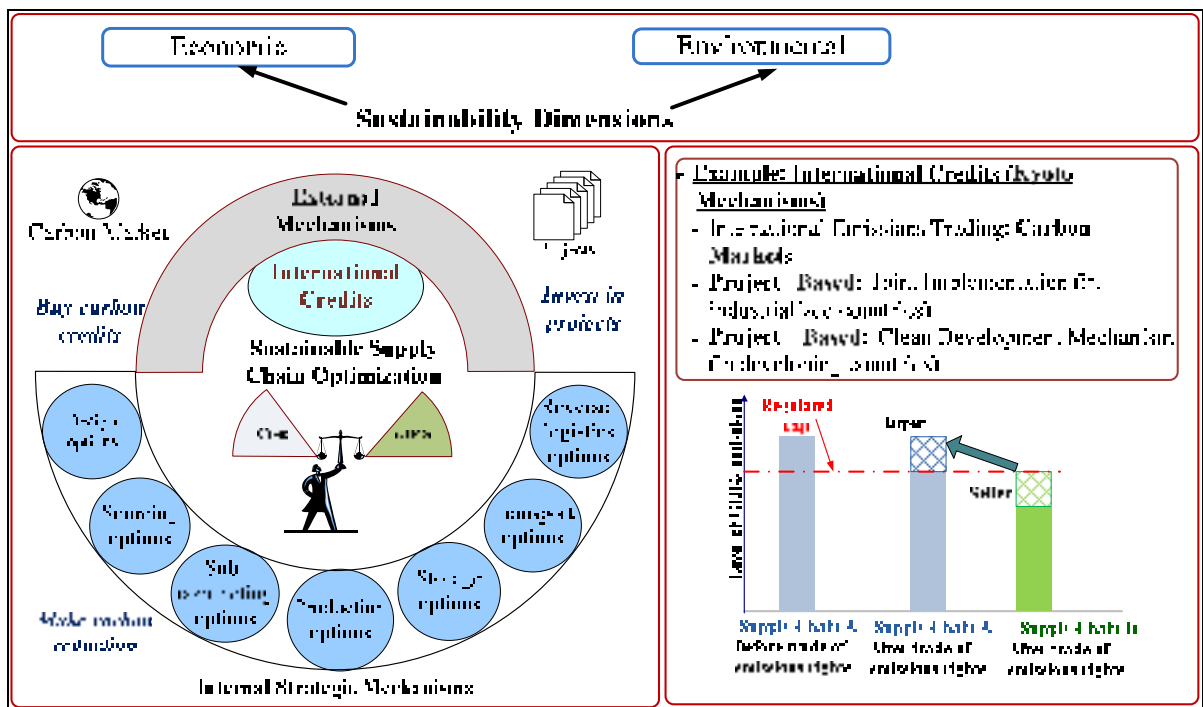

Figure 3.1 Sustainable supply chain design methodology.

As illustrated in Figure 3.1, the proposed methodology at its core is essentially a supply chain design approach that links carbon emissions to financial data with putting a price tag on them. It identifies various alternatives, both internal and external to the firm, in order to meet GHG reduction targets at a cost effective manner. Internal alternatives include changes in technology or supply chain strategies while the external mechanism considers buying or selling carbon credits. Thus, if we consider a supply chain where GHG emissions are more than the “Regulated Cap” (see Figure 3.1), two solutions are possible :

- if the cost of reducing one tCO₂e is more than the carbon price in the market, it is better to buy carbon credits from the market;
- if the cost of reducing one tCO₂e is less than the carbon price, it is better to implement some strategic decisions to achieve the target in term of GHG reduction.

Fundamental to the solution methodology is the use of a mixed integer program (MIP) to capture the interaction between the economic and the environmental dimensions. Two objective functions are considered. The first one is the total logistic cost and the second represents the total inventory of GHG emissions of the different supply chain activities. Sustainable supply chain network try to finds the ideal solution that minimize cost and GHG simultaneously which is rarely feasible. In this case, the use of a multi-objective technique such as “goal programming” or “ ϵ -constraint” methods (Andersson, 1999) are very useful in this case to find a trade-off solution or the Pareto frontier curve.

3.4 Mathematical model

This section presents a multi-objective mixed integer linear program at the heart of our methodology. As shown in Figure 3.2, the supply chain considered is composed of different potential suppliers (V) from whom raw materials are purchased, a set of sub-contractors and plants (S) where products are manufactured and distributed to various customers zones (D) in different regions. Different technologies can be acquired to manufacture products and different transportation modes are used for product delivery between the nodes of the network (suppliers, sub-contractors, plants, and customers). Although distribution and recycling centres stages are not considered in this study, it is very easy to add them in the model.

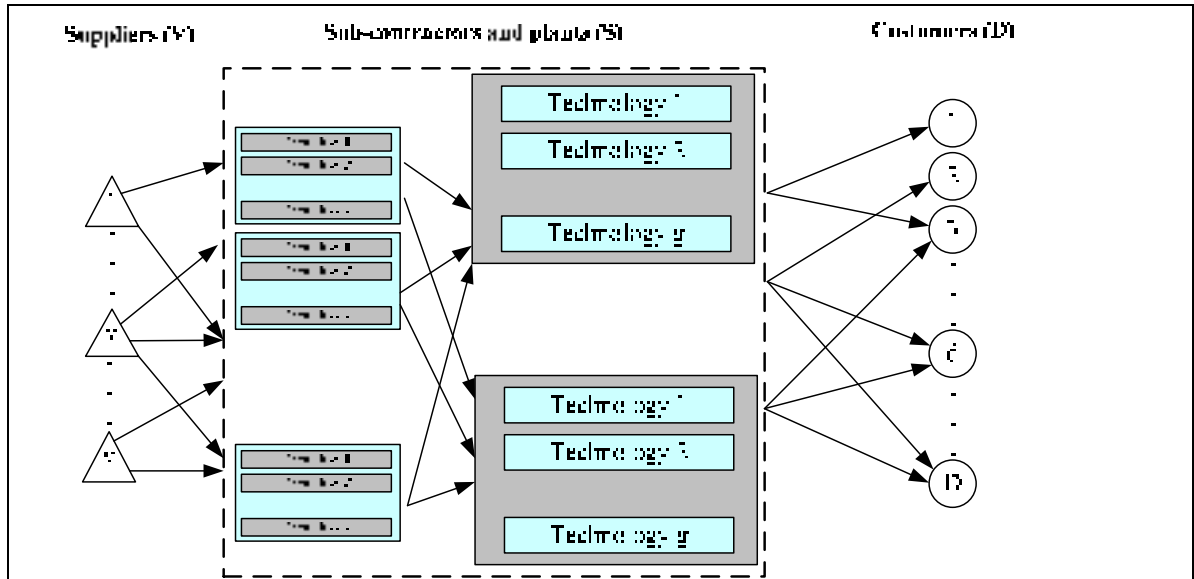

Figure 3.2 Supply chain network structure.

Two objective functions are considered. On the one hand, the objective of economic sustainability is to minimize the total logistics cost (F_1) of the supply chain, while on the other hand, the objective of environmental sustainability is to minimize the total emissions quantity of GHG (F_2) calculated in units of tonnes of carbon dioxide equivalent (tCO₂e). The total logistic cost (F_1) is calculated as the summation of fixed costs (FC), variable costs (VC), and carbon credits component (CC) :

$$F_1 = FC + VC + CC \quad (3.1)$$

Fixed costs are associated with the opening of facilities ($\sum_{i \in V \cup S} \lambda_i A_i$), technology acquisition ($\sum_{i \in S} \sum_{g \in G} \kappa_i^g W_i^g$), and assignment of raw material and production to the various sites ($\sum_{i \in V_p \cup S_p} \sum_{p \in R \cup M} a_{ip} Y_{ip}$) (see the Appendix for a full description of the variables and parameters) :

$$FC = \sum_{i \in V \cup S} \lambda_i A_i + \sum_{i \in S} \sum_{g \in G} \kappa_i^g W_i^g + \sum_{i \in V_p \cup S_p} \sum_{p \in R \cup M} a_{ip} Y_{ip} \quad (3.2)$$

Variable costs are of four types : supply of raw materials ($\sum_{p \in R} \sum_{i \in V_p} b_{ip} X_{ip}$), production and assembly of manufactured products ($\sum_{p \in R} \sum_{i \in S_p} \sum_{g \in G} c_{ip}^g Q_{ip}^g$), shipment costs ($\sum_{i \in S \cup V} \sum_{j \in S \cup D} \sum_{k \in K} l_{ij}^k U_{ij}^k$), and transportation costs ($\sum_{p \in M \cup R} \sum_{i \in S_p \cup V_p} \sum_{j \in SP_p^s \cup D} \sum_{k \in K} t_{ijp}^k F_{ijp}^k$).

$$VC = \sum_{p \in R} \sum_{i \in V_p} b_{ip} X_{ip} + \sum_{p \in R} \sum_{i \in S_p} \sum_{g \in G} c_{ip}^g Q_{ip}^g + \sum_{i \in S \cup V} \sum_{j \in S \cup D} \sum_{k \in K} l_{ij}^k U_{ij}^k + \sum_{p \in M \cup R} \sum_{i \in S_p \cup V_p} \sum_{j \in SP_p^s \cup D} \sum_{k \in K} t_{ijp}^k F_{ijp}^k \quad (3.3)$$

For the carbon credit component (CC), we assume that the supply chain needs to be in compliance with a regulation that limits GHG emissions. Let $L_{Emission}$ denote the limit (voluntary or mandated) on emissions known as the “regulated cap” for the specific planning period. In this case, if the total carbon dioxide emissions, which is the summation of GHG emissions from transportation ($\sum_{p \in M \cup R} \sum_{i \in S_p \cup V_p} \sum_{j \in SP_p^s \cup D} \sum_{k \in K} \alpha^k \pi_p d(i, j) F_{ijp}^k$) and manufacturing activities ($\sum_{p \in M} \sum_{i \in S_p} \sum_{g \in G} \beta_{ip}^g \pi_p Q_{ip}^g$) are below the cap, the supply chain would be allowed tradable credits.

Otherwise, there is a need to reduce emission through internal mechanisms or to buy an equivalent amount of carbon credits to meet regulatory obligation. Let ϕ denote the market price of an allowance under the carbon market. Thus, the carbon credit component is calculated as following :

$$CC = \phi \left(\sum_{p \in M \cup R} \sum_{i \in S_p \cup V_p} \sum_{j \in SP_p^s \cup D} \sum_{k \in K} \alpha^k \pi_p d(i, j) F_{ijp}^k + \sum_{p \in M} \sum_{i \in S_p} \sum_{g \in G} \beta_{ip}^g \pi_p Q_{ip}^g - L_{Emission} \right) \quad (3.4)$$

A second objective is the evaluation of the supply chain from a purely environmental perspective. Thus, the objective of environmental sustainability is to minimize the total

emissions quantity of GHG emissions (F_2) calculated in terms of tonnes of carbon dioxide equivalent (tCO₂e) is as follows :

$$\text{Min } F_2 = \sum_{p \in M \cup R} \sum_{i \in S_p \cup V_p} \sum_{j \in SP_p^s \cup D} \sum_{k \in K} \alpha^k \pi_p d(i, j) F_{ip}^k + \sum_{p \in M} \sum_{i \in S_p} \sum_{g \in G_p} \beta_{ip}^g \pi_p Q_{ip}^g \quad (3.5)$$

The MILP supply chain network design model the typical design constraints such as supplier and subcontractors selection, demand and capacity constraints, manufacturing according to the specification of a bill of material (BOM), network structure constraints, emissions constraints and transportations constraints. The detailed model can be seen in the Appendix.

3.5 Solution methods

The proposed methodology for sustainable supply chain design considers the evaluation of the supply chain performance based on both : (i) the total logistic cost and (ii) the environmental impact. The objective is to find the supply chain configuration (design) and planning decisions that minimizes cost and GHG emissions at the same time. Therefore, in this particular case, the mathematical model can be formulated as following :

$$\begin{aligned} &\text{Find : } \mathbf{X} = [x_1, x_2, \dots, x_n]^T \\ &\text{To minimize: } F(\mathbf{X}) = \begin{pmatrix} F_1(\mathbf{X}) = \text{Total Logistic Cost} \\ F_2(\mathbf{X}) = \text{GHG Emissions} \end{pmatrix} \\ &\text{subject to: } \left\{ \begin{array}{l} g_j(\mathbf{X}) \leq 0; \quad j=1,2,\dots,m \\ h_l(\mathbf{X}) = 0; \quad l=1,2,\dots,e \end{array} \right\} \left\{ \begin{array}{l} \text{Supplier and subcontractors selection constraints} \\ \text{Demand and capacity constraints} \\ \text{BOM Constraints} \\ \text{Network structure constraints} \\ \text{Emissions constraints} \\ \text{Transportation constraints} \\ \dots \end{array} \right. \quad (3.6) \end{aligned}$$

Where \mathbf{F} is the utility function and \mathbf{X} represents the vector of decision variables (continuous and binaries), respectively belonging to the feasible region of equality ($h_l(\mathbf{X})=0; l=1,2,\dots,e$) and inequality constraints ($g_j(\mathbf{X})\leq 0; j=1,2,\dots,m$) detailed in the appendix.

Generally, a multi-objective optimization problem can be handled in four different ways depending on when decision makers articulate their preference concerning the different objectives : never, before, during or after the actual optimization procedure. In the first two approaches, the different objectives are aggregated to one overall objective function. Optimization is then conducted with one optimal design as the result. The result is then strongly dependent on how the objectives were aggregated. Moreover, these methods do not use any preference information. Examples are the “MinMax” formulation and global criterion method (Andersson, 1999). The third approach is an iterative process where the decision-maker progressively articulates his preferences on the different objectives. They rely on progressive information about the decision-makers preferences simultaneously as they search through the solution space. In the fourth and final approach, optimization is conducted without the decision maker articulating any preferences among the objectives. The outcome of this optimization is a set of Pareto optimal solutions which elucidate the trade-off between the objectives. The decision-maker then has to trade the objectives against each other in order to select the final design.

In this paper, we explore two solutions procedures to solve the multi-objective optimization problem for designing and evaluating sustainable supply chains. The first one is the “ ϵ -constraint” method. In this method (with posterior articulation of preference), one objective is selected for optimization and the others are reformulated as constraints (Andersson, 1999), i.e. :

$$\left(\begin{array}{l} \text{Find : } \mathbf{X} = [x_1, x_2, \dots, x_n]^T \\ \text{To minimize: } F(\mathbf{X}) = \begin{cases} F_1(\mathbf{X}) = \text{Total Logistic Cost} \\ F_2(\mathbf{X}) = \text{GHG Emissions} \end{cases} \\ \text{s.t. : } \begin{cases} g_j(\mathbf{X}) \leq 0; \quad j=1,2,\dots,m \\ h_l(\mathbf{X}) = 0; \quad l=1,2,\dots,e \end{cases} \end{array} \right) \Rightarrow \left(\begin{array}{l} \text{Find: } \mathbf{X} = [x_1, x_2, \dots, x_n]^T \\ \text{To minimize: } F(\mathbf{X}) = F_1(\mathbf{X}) \\ \text{s.t. : } \begin{cases} F_2(\mathbf{X}) \leq \varepsilon \\ g_j(\mathbf{X}) \leq 0; \quad j=1,2,\dots,m \\ h_l(\mathbf{X}) = 0; \quad l=1,2,\dots,e \end{cases} \end{array} \right) \quad (3.7)$$

By progressively changing the constraint values, ε , which represent the limit on GHG emissions in this case, different points on the Pareto-front could be sampled. By calculating the extremes of the Pareto-front the range of different objective functions could be calculated and constraint values selected accordingly. The second method is the goal programming (GP). The GP model could be placed in the third category. The algebraic formulation of GP is given as following :

$$\left(\begin{array}{l} \text{Find : } \mathbf{X} = [x_1, x_2, \dots, x_n]^T \\ \text{To minimize: } F(\mathbf{X}) = \begin{cases} F_1(\mathbf{X}) = \text{Total Logistic Cost} \\ F_2(\mathbf{X}) = \text{GHG Emissions} \end{cases} \\ \text{s.t. : } \begin{cases} g_j(\mathbf{X}) \leq 0; \quad j=1,2,\dots,m \\ h_l(\mathbf{X}) = 0; \quad l=1,2,\dots,e \end{cases} \end{array} \right) \Rightarrow \left(\begin{array}{l} \text{Find: } \mathbf{X} = [x_1, x_2, \dots, x_n]^T \\ \text{To minimize: } Z = \sum_{i=1}^2 (u_i n_i + v_i p_i) \\ \text{s.t. : } \begin{cases} F_i(\mathbf{X}) + n_i + p_i = F_i^*, \quad i = 1, 2 \\ g_j(\mathbf{X}) \leq 0; \quad j=1,2,\dots,m \\ h_l(\mathbf{X}) = 0; \quad l=1,2,\dots,e \end{cases} \end{array} \right) \quad (3.8)$$

Where F_i^* is the target value for the objective function F_i which usually represents the minimum value obtained by considering this objective in the optimization process; n_i and p_i represent the negative and positive deviations from this target value. The manager must analyze each one of the *goals* considered in the model in terms of whether over or underachievement of the goal is satisfactory where achievement implies that a goal has been reached. The terms u_i and v_i are the respective positive weights attached to these deviations in the achievement function Z . The weight factor of a given objective represents two different roles (Kettani et al., 2004). The first one is “normalization” that brings all deviations to a common unit of measurement. The second is “valorization” reflecting the decision maker’s

preference structure. For instance, these weights take the value zero if the minimization of the corresponding deviational variable is unimportant to decision makers. The “ ϵ -constraint” method first helps the decision maker to identify different possible solutions and the characteristic of each objective. Once he obtains, he can go through a decision process where he can articulate the preference structure and choose the trade-off solution that guarantee the different objectives.

3.6 Optimization methodology for sustainable supply chain design

The methodology to design and evaluate sustainable supply chains is presented in Figure 3.3. In the first step, the problem is represented as a mathematical model (see appendix for detailed model). Data for a particular instance of the supply chain are obtained from the enterprise information system and from other sources and stored in a database. Once the database completed, the model is populated by a program developed in Microsoft Visual Basic 6.0. The program reads the data from the database and creates an LP file which is then solved by ILOG CPLEX[®]. At this step, decision makers are ready to begin the analysis and evaluation of the supply chain. If the importance of each objective is not completely known, a set of efficient solutions and the Pareto frontier curve using the “ ϵ -constraint” method can be generated. However, if they have preferences regarding the objective functions and their importance, then Goal Programming can be used with various weights to identify the best trade-off among the solutions.

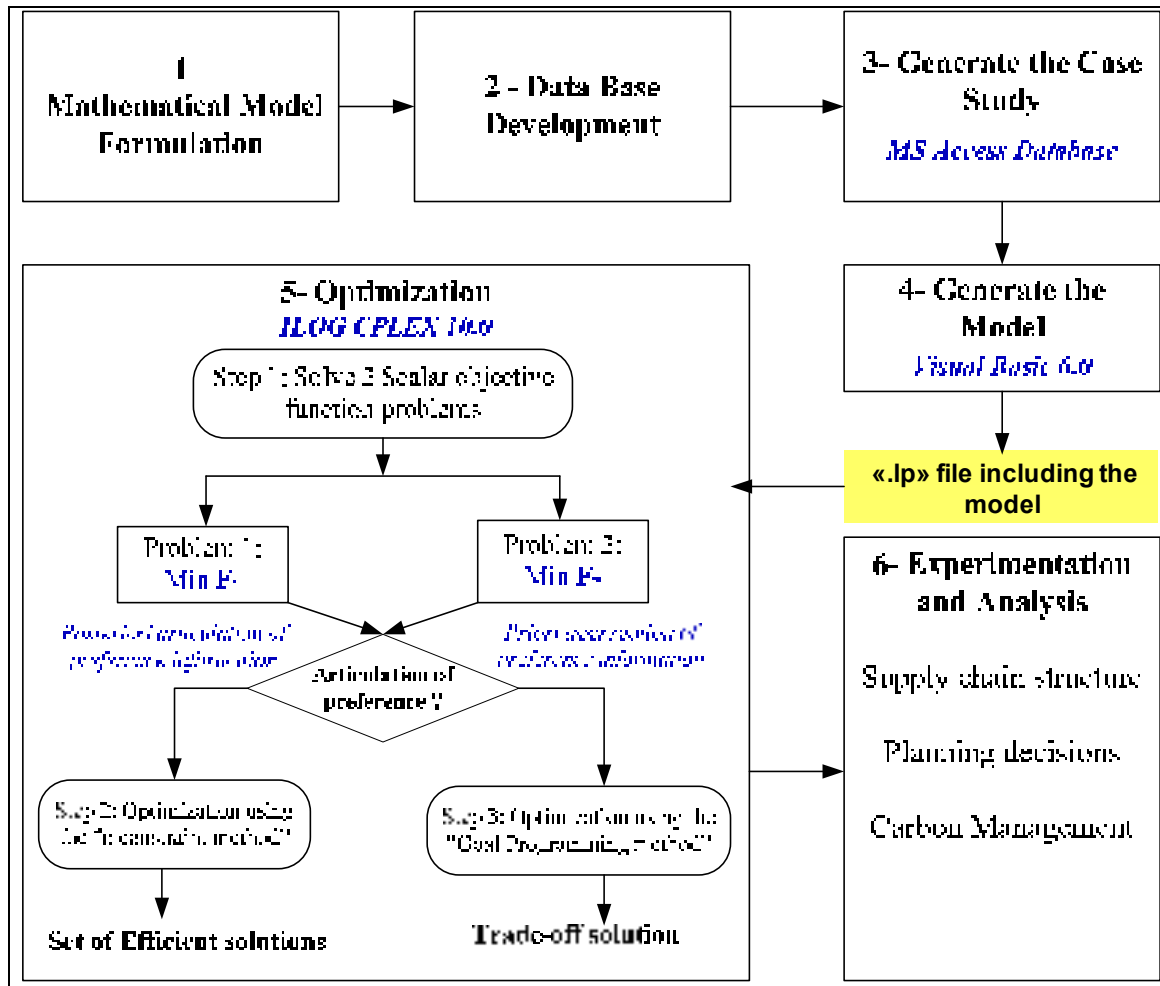

Figure 3.3 Optimization methodology for sustainable supply chain design.

3.7 Experimental evaluation

In this section we consider the case of a firm that produces steel products with high levels of GHG emissions and that is subject to a regulation that caps carbon emissions. The different products are aggregated into one product family with two semi finished products that are assembled from four parts sourced from various external suppliers. Indeed, it is commonly known that aggregated information about products is used especially when dealing with decisions at the strategic level. Three transportation modes are considered : rail, air, and road to ship products between supply chain stages. In this study, emissions are limited to carbon dioxide (CO₂) caused by production and transportation activities. Emissions factors for the

three transportation modes are detailed in Table 3.1. The Emissions factors (α^k) considered in this example are based on the recent accurate study published in (Facanha and Horvath, 2007). The manufactured products are primarily composed of steel materials. The emission factors (β_{ip}^g) for different technologies are obtained from the IPCC Emission Factor Data Base [e.g. $\beta_{ip}^g = 1.6$ tons CO₂/ton steel product]¹.

Table 3.1
Transportation modes and emissions factors (grams/ton-mile)

Modes	Type	Payload (tons)	CO₂ (grams/ton-mile)
Road	Class 8b	12.5	187
Rail	Intermodal rail	2,093	40
Air	Boeing 747-400	70	1,385

The model is first solved by CPLEX Interactive Optimizer 10.0 considering that only internal abatement mechanisms are available and there is no interaction with the carbon market. Two scenarios are analysed. In the first one, the model is solved considering only the objective function that minimizes cost (**F**₁). The optimal cost is \$28,508,190. The total emissions quantity relative to this solution is 80,191 tCO₂e. Next the model is solved for optimal levels of GHG emissions (**F**₂). The optimal GHG emissions quantity for the most environmental supply chain is 20,312 tCO₂e but at a total cost of \$44,935,790. Thus, if we suppose that the actual supply chain is optimized based on cost, a fourfold reduction in carbon emissions can be achieved at two times the cost of the current solution. Thus, the average abatement cost

¹ http://www.ipcc-nggip.iges.or.jp/EFDB/find_ef.php

(AAC), which is the average cost of reducing one tone of CO₂ from the current situation, is equal to \$274.

Table 3.2
Marginal abatement cost without carbon market integration

Scenario	Scenario 1	Scenario 2	Comparison
Total cost (\$)	28,508,190	44,935,790	Cost increase by 158 %
GHG emission (tCO ₂ e)	80,191	20,312	GHG reduced by a factor of 4
			AAC = \$274

In the second step, the integration of environmental regulation that caps GHG emissions as well as the interaction with the carbon trading market are considered. Under the regulatory framework for industrial greenhouse gas emissions (Government of Canada, 2008), the limit of emission is fixed to 60,000 tCO₂ for the planning period, which represents a reduction of 25% of carbon emission when compared to Scenario 1. The price of one tonne of CO₂ is assumed to be equal to \$15 (Government of Canada, 2008). The model is solved again for the two scenarios. In the first case (scenario 1), we observe that the decision is the acquisition of carbon credits from the carbon market and this represent an additional cost for the company (emissions cost). However, if the purely environmental solution (scenario 2) is considered, a carbon credit for 39,688 tCO₂e (60,000 – 20,312) can be obtained for a price of \$595,315 (see Table 3.3).

Table 3.3
Marginal abatement cost with carbon market integration

Scenario	Scenario 1	Scenario 2	Comparison
Total cost (\$)	28,811,054	44,340,790	Cost increase by 154 %
GHG emissions (tCO ₂ e)	80,191	20,312	GHG reduced by a factor of 4
Emission cost	302,864	(595,315)	
			AAC = \$259

The average abatement cost is now equal to \$259. Figure 3.4 shows the cost breakdown of the extreme solutions (scenarios 1 and 2). As can be seen, production and transportation costs increase significantly because of the use of greener production technologies and more environmental transportation modes in scenario 2. However, the raw material cost is the same for the both scenarios. This means that supplier selection results remain the same for the two solutions.

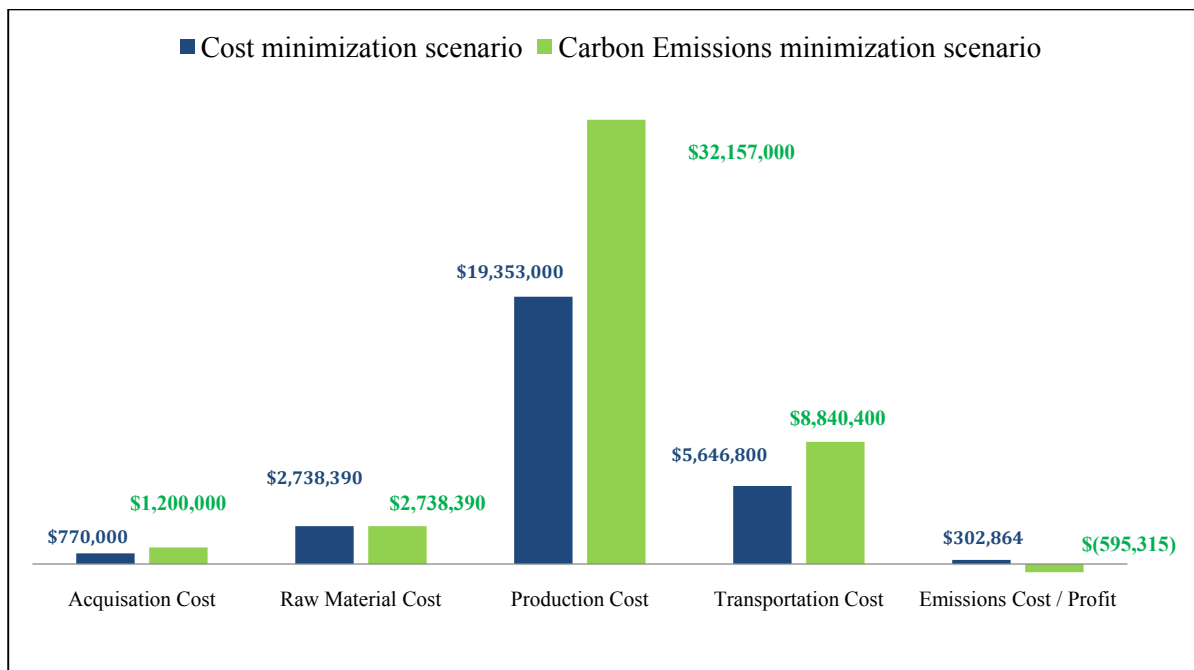

Figure 3.4 Cost analysis of extreme solutions (scenario 1 versus scenario 2).

To observe the sensitivity of the total logistics cost versus carbon emissions reduction, this following constraint is added to the model (“ ϵ -constraint” method) and solved for different values of upper bounds of total carbon emissions for the supply chain, and denoted $UB_{Emission}$.

$$\underbrace{\sum_{p \in M \cup R} \sum_{i \in S_p \cup V_p} \sum_{j \in S(Suc(P)) \cup D} \sum_{k \in K} \alpha^k \pi_p d(i, j) F_{ijp}^k}_{\text{GHGs Emissions from transportation}} + \underbrace{\sum_{p \in M} \sum_{i \in S_p} \sum_{g \in G_p} \beta_{ip}^g \pi_p Q_{ip}^g}_{\text{GHGs Emissions from process}} \leq UB_{Emission} \quad (3.9)$$

Figure 3.5 shows that the total logistics cost decreases as the upper bound of CO₂e emissions ($UB_{Emission}$) increases, the model seeking less costly solution alternatives which have higher

emission rates. From a managerial perspective, this means that those companies might have to look for new production or transportation alternatives and invest in environmentally friendly technologies in order to reduce GHG emissions. However, the delivery lead time might increase in this case. Figure 3.5 also shows that the total logistics cost (F_1) and carbon emissions (F_2) are two conflicting objectives. Thus, the application of a multi-objective optimization procedure could help to determine the best trade-off.

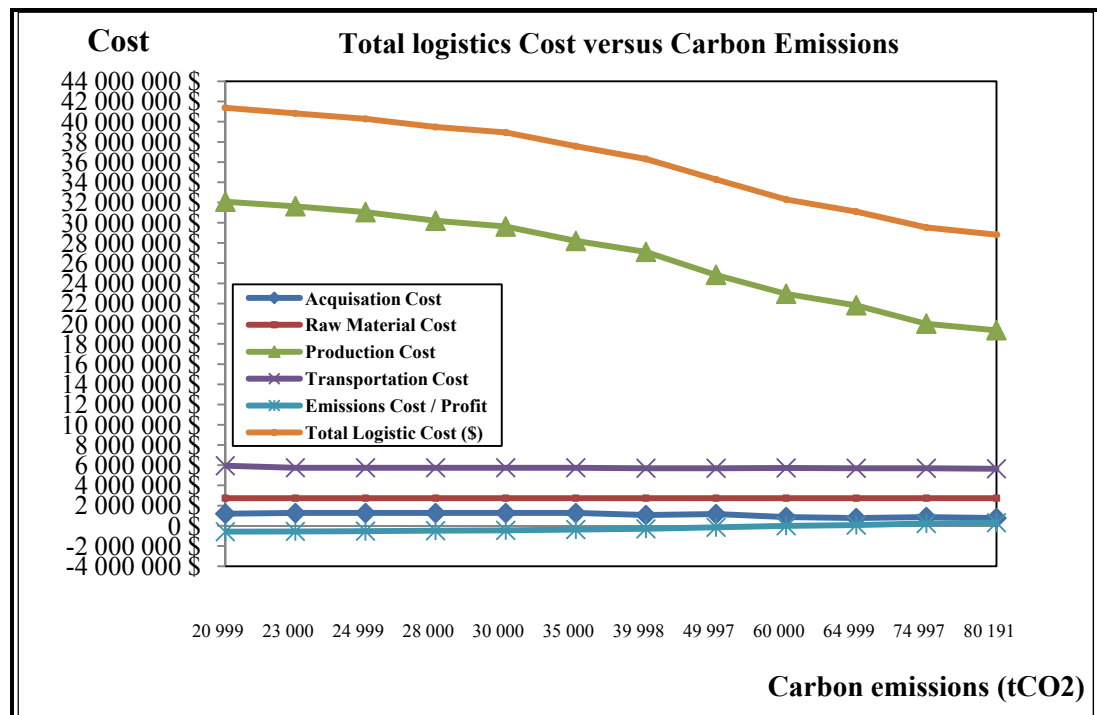

Figure 3.5 Logistic costs versus carbon emissions.

The interaction with the emission trading system helps the company to characterize exactly the average abatement cost of carbon emissions as a function of carbon emissions reduction target (see Figure 3.6). For example, if the objective is to reduce carbon emissions by 25%, then the average abatement cost is equal to \$173/tCO₂.

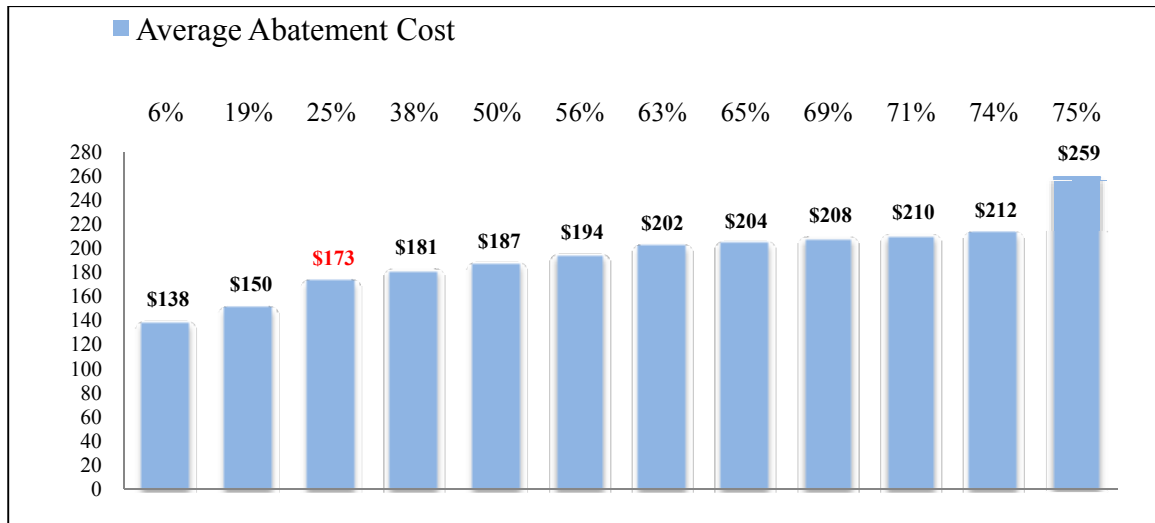

Figure 3.6 Average abatement cost versus carbon emissions reduction.

In addition, the decision in term of buying or selling carbon credit from the carbon market is defined (see Figure 3.7). In the case where the objective is to reduce carbon emissions less than 25%, the company should buy credits form the carbon market (buyer). However, if the target in term of GHG reduction is more than 25%, then the company might sell some carbon credit to reduce the impact of the environmental legislation on the economic objective.

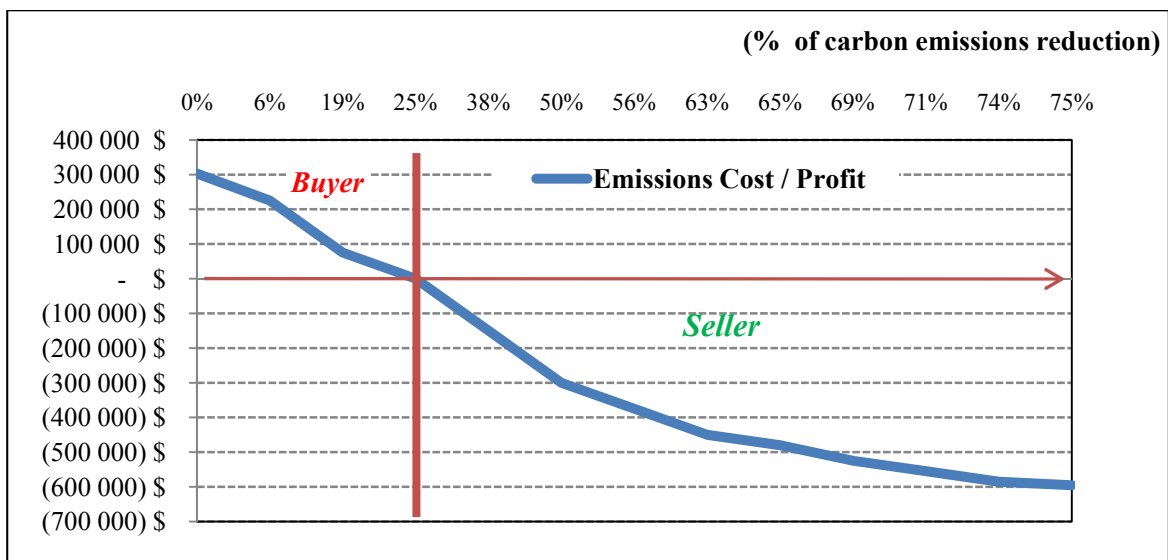

Figure 3.7 Emissions cost / profit component.

The goal programming (GP) method was used for the previous example in order to find the trade-off between the total logistics cost and GHG emissions. Table 3.2 summarizes the various solutions. The GP solution has an emission quantity of 49,312 tCO₂e for an operational cost of \$34,283,644. The total logistic cost for the GP solution is only 18% greater than the efficient scenario. This example demonstrates that by using a multi-objective approach, it is possible to look at various solution trade-offs that reduces GHG emissions while maintaining logistics costs under control.

Table 3.4
Goal programming solution

Optimization scenarios	Total Operational Cost	tCO₂e
Scenario 1 - <i>Cost minimization</i>	$F_1^* = \$28,811,054$	$F_2 = 80,191$
Scenario 2 - <i>GHG emissions minimization</i>	$F_1 = \$44,340,790$	$F_2^* = 20,312$
Trade-offs scenario – <i>Goal programming</i>	$F_1 = \$34,283,644$	$F_2 = 49,997$

This case study demonstrates that the proposed methodology has the potential to be a tool for policy makers. The evaluation of the economic impact of regulation of the supply chain is identified with more accuracy and loopholes can be eliminated. For instance the impact of non homogenous carbon prices in varying geographies can have a negative impact on the social or environmental aspects of supply chain sustainability as they seek lower prices for carbon.

3.8 Conclusion

The main contribution of this paper is the development of an integrated model for sustainable supply chain network design leveraging the opportunities offered by carbon trading markets. Using the model, supply chain managers are now able to determine the GHG footprint of supply chains operations. They can determine if they qualify for carbon credits or must purchase credits on the carbon market place. That will help them decide on the best

configuration strategy for their supply chain to be in compliance with regulations and achieve sustainability objectives.

Moreover, the proposed approach helps supply chain managers to evaluate the average abatement cost as a function of carbon emissions reduction targets which is important to analyse within the context of the Kyoto Protocol as illustrated by the case study. From a managerial perspective, the solution methodology provides valuable insights into the design and evaluation of sustainable supply chain and guides decision-makers towards the adoption of the most cost-effective options as regulations become stronger.

The methodology presented here is general enough and may be applied to other supply chain studies to design sustainable supply chain and evaluate their performance in term of cost and carbon emissions. However, the mathematical model considers only a unique price at the time for carbon emissions which may be not realistic especially with the high volatility of carbon prices observed last years and the expected change in the future. Thus, a multi-period model for sustainable supply chain network design under the emission trading scheme where carbon prices are subject to possible changes is important to add and subject to future development. Finally, the inclusion of other product life cycle stage that include distribution and reverse logistics activities should be added to study more realistic supply chains.

3.9 Appendix : mathematical model

3.9.1 Sets and indices

In this study, the following sets and indices are used :

P	Set of all products
$R \subset P$	Set of raw materials
$M \subset P$	Set of manufactured products

$C \subset M$	Set of finished products
N	Set of all nodes
G	Set of manufacturing technologies
$D \subset N$	Set of customer zones
$S \subset N$	Set of all subcontractors
$S_p \subset S$	Set of subcontractors of product $p \in M$
$V \subset N$	Set of suppliers of raw materials
$V_p \subset V$	Set of suppliers of raw material $p \in R$
P_p^s	Set of immediate successors of product $p \in P/C$ in the BOM
SP_p^s	Set of subcontractors for the set of immediate successors of product $p \in P/C$
M_i	Set of products that can be manufactured by subcontractor $i \in S$
R_i	Set of raw materials that can be supplied by supplier $i \in V$
K	Set of all transportation modes $k \in K$

3.9.2 Parameters

The strategic mathematical model requires the following cost parameters :

λ_i	Fixed cost associated with the use of site $i \in S \cup V$
κ_i^g	Fixed cost associated with the acquisition of technology $g \in G$ at site $i \in S$
a_{ip}	The start-up cost associated with manufacturing product $p \in M$ at site $i \in S_p$
b_{ip}	Purchasing unit cost of raw material $p \in R$ at site $i \in V_p$
c_{ip}^g	Unit cost of producing product $p \in M$ at site $i \in S_p$ using technology $g \in G$
t_{ijp}^k	transportation unit cost of product $p \in P$ from node $i \in V_p \cup S_p$ to node $j \in SP_p^s \cup D$ using transportation mode $k \in K$

l_{ij}^k	Cost of a single shipment between nodes $i \in V \cup S$ and $j \in S \cup D$ using transportation mode $k \in K$
ϕ	Price per metric ton of carbon dioxide equivalent (tCO ₂ e)

The following data are also needed :

α^k	Greenhouse gases emissions factor per weight unit and per distance unit due to the use of transportation mode $k \in K$ per ton-mile
β_{ip}^g	Greenhouse gases emissions factor (tones) per weight of produced quantity of product $p \in M$ using the technology $g \in G$ at node $i \in S_p$
$L_{Emissions}$	Limit of emissions fixed by government regulation
$\theta_{pp'}$	Number of products $p \in P/C$ required to manufacture one unit of product $p' \in P_p^s$
m_p	Maximum number of sites that can be opened for product $p \in M \cup R$
e_{ip}	Capacity of node $i \in S_p$ for product $p \in R$ (supplier's capacity)
f_i^g	Available time at node $i \in S$ when using technology $g \in G$
te_{ip}^g	Processing time on product $p \in M$ at node $i \in S_p$ using technology $g \in G$
d_{pd}	Number of product $p \in C$ required by demand node $d \in D$
ρ_i	Lower bound (in %) on the aggregated capacity to be used if manufacturer or supplier $i \in S \cup V$ is chosen
T_i	Total time available at the assembly line of subcontractor $i \in S$
τ_{ij}	Maximum number of transportation modes that can be used between nodes $i \in V \cup S$ and $j \in S \cup D$
κ^k	Volume capacity of transportation mode $k \in K$
ψ^k	Weight capacity of transportation mode $k \in K$
π_p	Weight of product $p \in P$

δ_p	Volume of product $p \in P$
$d(i, j)$	Distance between nodes $i \in V \cup S$ and $j \in S \cup D$

3.9.3 Decision variables

To find the optimal configuration of the network, the following decision variables are required :

A_i	Binary variable equals 1 if node $i \in V \cup S$ is open and operational for at least one product
W_i^g	Binary variable equals 1 if technology $g \in G$ is selected at node $i \in S$
Y_{ip}	Binary variable equals 1 if raw material $p \in R \cup M$ is assigned to node $i \in V_p \cup S_p$ and 0 otherwise
X_{ip}	Number of units of product $p \in R$ supplied by node $i \in V_p$
Q_p^g	Number of units of product $p \in M$ manufactured by node $i \in S_p$ using technology $g \in G$
F_{ijp}^k	Number of units of product $p \in P$ shipped from node $i \in V_p \cup S_p$ to node $j \in SP_p^s \cup D$ using transportation mode $k \in K$
U_{ij}^k	Number of shipments between nodes $i \in V \cup S$ and $j \in S \cup D$ using transportation mode $k \in K$
Z_{ij}^k	Binary variable equals 1 if transportation mode $k \in K$ is used between nodes $i \in V \cup S$ and $j \in S \cup D$ and 0 otherwise

3.9.4 Objective functions

In the following model, two objective functions are considered :

- Economic sustainability (F_1) : Minimize the total logistics cost of the supply chain considering fixed, variable, and emissions costs.

- Environmental sustainability (F₂) : Minimize the total quantity of GHG emissions calculated in units of tons of carbon dioxide equivalent (tCO₂e).

Table 3.5
Cost structure of the objective function F₁

Cost structure	Mathematical formulation
Fixed cost for facilities	$\sum_{i \in V \cup S} \lambda_i A_i$
Fixed cost for assignment products to sites	$\sum_{p \in R \cup M} \sum_{i \in V_p \cup S_p} a_{ip} Y_{ip}$
Fixed cost for technology acquisition	$\sum_{i \in S} \sum_{g \in G} \kappa_i^g W_i^g$
Fixed cost for transportation lanes	$\sum_{i \in V \cup S} \sum_{j \in S \cup D} \sum_{k \in K} l_{ij}^k U_{ij}^k$
Raw materials cost	$\sum_{p \in R} \sum_{i \in V_p} b_{ip} X_{ip}$
Manufacturing cost	$\sum_{p \in R} \sum_{i \in S_p} \sum_{g \in G} c_{ip}^g Q_{ip}^g$
Transportation cost	$\sum_{p \in M \cup R} \sum_{i \in S_p \cup V_p} \sum_{j \in SP_p^s \cup D} \sum_{k \in K} t_{ijp}^k F_{ijp}^k$
GHG Emissions cost / profit	$\phi \left(\underbrace{\sum_{p \in M \cup R} \sum_{i \in S_p \cup V_p} \sum_{j \in SP_p^s \cup D} \sum_{k \in K} \alpha^k \pi_p d(i, j) F_{ijp}^k}_{\text{GHGs Emissions from transportation}} + \underbrace{\sum_{p \in M} \sum_{i \in S_p} \sum_{g \in G} \beta_{ip}^g \pi_p Q_{ip}^g}_{\text{GHGs Emissions from production}} - \underbrace{L}_{\text{Emission Cap}} \right)$

The GHG emissions cost/profit is calculated based on the credits compared to the limit of emissions $L_{Emission}$ fixed by regulations. Therefore, the objective function F₁ that represents the total operational cost to be minimized is :

$$\text{Min } \mathbf{F}_1 = (1)+(2)+(3)+(4)+(5)+(6)+(7)+(8) \quad (3.10)$$

The objective function (\mathbf{F}_2) is to minimize the total emissions quantity of GHG (tCO₂e) in order to evaluate the best potential reduction in term of GHG emissions.

$$\text{Min } \mathbf{F}_2 = \underbrace{\sum_{p \in M \cup R} \sum_{i \in S_p \cup V_p} \sum_{j \in SP_p^s \cup D} \sum_{k \in K} \alpha^k \pi_p d(i, j) F_{ijp}^k}_{\text{GHGs Emissions from transportation}} + \underbrace{\sum_{p \in M} \sum_{i \in S_p} \sum_{g \in G} \beta_{ip}^g \pi_p Q_{ip}^g}_{\text{GHGs Emissions from manufacturing}} \quad (3.11)$$

3.9.5 Constraints

For the MILP supply chain network design model, there are many constraints to be considered. These constraints are of many kinds including the balance constraints of all products, the capacity limit constraints, the minimum capacity occupation constraints, and the demand satisfaction constraint. The BOM constraints are implicitly taken into account in the balance constraints. These elements are discussed below.

For each raw material and for each manufactured product, the number of operational sites should not exceed the maximum number allowed of suppliers and subcontractors :

$$\sum_{i \in S_p \cup V_p} Y_{ip} \leq m_p \quad (\forall p \in R \cup M) \quad (3.12)$$

If a product (raw material) is assigned to a node (supplier), then the number of products supplied by this supplier must not exceed its capacity for this product :

$$X_{ip} - e_{ip} Y_{ip} \leq 0 \quad (\forall p \in R, \forall i \in V_p) \quad (3.13)$$

A product (semi-finished or final product) is manufactured in a node (subcontractor) only if the product is assigned to this node :

$$\sum_{g \in G} Q_{ip}^g - MY_{ip} \leq 0 \quad (\forall p \in M, \forall i \in S_p) \quad (3.14)$$

Then the overall processing time used must not exceed the total available time at its assembly line or manufacturing facility :

$$\sum_{p \in M_i} te_{ip}^g Q_{ip}^g - f_i^g W_i^g \leq 0 \quad (\forall i \in S, \forall g \in G) \quad (3.15)$$

There is usually a minimum amount of the aggregate capacity of a subcontractor that should be consumed to justify the establishment of a contract. This consideration leads to constraints (7) where the first term is the total time used at the assembly line or manufacturing facility of subcontractor i in order to manufacture all the products. The second term of the left hand side of the inequality is the minimum time to be used :

$$\sum_{p \in M_i} \sum_{g \in G} te_{ip}^g Q_{ip}^g - \rho_i \sum_{g \in G} f_i^g W_i^g \geq 0, \forall i \in S \quad (3.16)$$

To make a deal with a supplier, the minimum capacity can also be considered. Here, the minimum capacity to be used is a percentage of the total weight of all maximum quantities of raw materials that can be supplied by the supplier :

$$\sum_{p \in R_i} X_{ip} - (\rho_i \sum_{p \in R_i} b_{ip}) A_i \geq 0 \quad (\forall i \in V) \quad (3.17)$$

The constraints of flow out of suppliers' nodes are given by the equalities below :

$$X_{ip} - \sum_{j \in SP_p^s \cup D} \sum_{k \in K} F_{ijp}^k = 0 \quad (\forall p \in P, \forall i \in V_p) \quad (3.18)$$

The constraints of flow out of subcontractors' nodes are given by the equalities below :

$$\sum_{g \in G} Q_{ip}^g - \sum_{j \in SP_p^s \cup D} \sum_{k \in K} F_{ijp}^k = 0 \quad (\forall p \in P, \forall i \in S_p) \quad (3.19)$$

For each product, the quantity that arrives to a node must equal the quantity needed to manufacture next higher assemblies :

$$\sum_{j \in S_p} \sum_{k \in K} F_{jip}^k - \sum_{p' \in P_p^s} \sum_{g \in G} \theta_{pp'} Q_{ip'}^g = 0 \quad (\forall p \in M, \forall i \in SP_p^s) \quad (3.20)$$

The quantity of finished products shipped from all its subcontractors to the demand node must equal the demand of that product :

$$\sum_{i \in S_p} \sum_{k \in K} F_{idp}^k = d_{pd} \quad (\forall p \in C, \forall d \in D) \quad (3.21)$$

For each couple of nodes, there is a maximum number of transportation modes that can be used :

$$\sum_{k \in K} Z_{ij}^k \leq \tau_{ij} \quad (\forall i \in V \cup S, \forall j \in S \cup D) \quad (3.22)$$

The quantity of products shipped between two nodes is limited by the capacity of transportation mode and the number of shipments. While the first set of constraints (3.23) expresses the volume capacity and the second set (3.24) expresses the weight capacity :

$$\sum_{p \in R_i \cup M_i} \delta_p F_{ijp}^k - \kappa^k U_{ij}^k \leq 0 \quad (\forall i \in V \cup S, \forall j \in S \cup D, \forall k \in K) \quad (3.23)$$

$$\sum_{p \in R_i \cup M_i} \pi_p F_{ijp}^k - \psi^k U_{ij}^k \leq 0 \quad (\forall i \in V \cup S, \forall j \in S \cup D, \forall k \in K) \quad (3.24)$$

The following are logical constraints. The number of shipments between two nodes for a given transportation mode is not nil only if the transportation mode is actually used. This yields to the following constraints :

$$U_{ij}^k - MZ_{ij}^k \leq 0 \quad (\forall i \in V \cup S, \forall j \in S \cup D, \forall k \in K), \text{ where } M \text{ is a big number} \quad (3.25)$$

A site is selected if it is open for one product at least :

$$Y_{ip} - A_i \leq 0 \quad (\forall i \in S \cup V, \forall p \in M_i \cup R_i) \quad (3.26)$$

The following are constraints on decision variables. The transport variables, the quantities supplied and manufactured by sites are non negative :

$$F_{ip}^k \geq 0 \quad (\forall p \in R \cup M, \forall i \in V_p \cup S_p, \forall j \in SP_p^S \cup D, \forall k \in K) \quad (3.27)$$

$$X_{ip} \geq 0 \quad (\forall (p,i) \in R \times V_p \cup M \times S_p) \quad (3.28)$$

$$Q_{ip}^g \geq 0 \quad (\forall p \in M \forall i \in S_p \forall g \in G) \quad (3.29)$$

Binary variables :

$$Y_{ip} \in \{0,1\}, \forall (p,i) \in R \times V_p \cup M \times S_p \quad (3.30)$$

$$A_i \in \{0,1\}, \forall i \in S \cup V \quad (3.31)$$

$$Y_{ip} \in \{0,1\}, \forall p \in R \cup M \forall i \in S \cup V \quad (3.32)$$

$$W_i^g \in \{0,1\}, \forall i \in S \forall g \in G \quad (3.33)$$

$$Z_{ij}^k \in \{0,1\} \quad (\forall i \in V \cup S, \forall j \in S \cup D, \forall k \in K) \quad (3.34)$$

The number of shipments must be integer :

$$U_{ij}^k \text{ integer} \quad (\forall p \in P, \forall i \in V_p \cup S_p, \forall j \in SP_p^s \cup D, \forall k \in K) \quad (3.35)$$

In the case of minimizing F_2 , the following constraints should be added to the model. No assignment of raw material to supplier if the raw material is not supplied by this supplier :

$$Y_{ip} - X_{ip} \leq 0 \quad (\forall P \in P, \forall i \in V_p) \quad (3.36)$$

No assignment of manufactured product to plants if the product is not manufactured in this plant

$$Y_{ip} - \sum_{g \in G} Q_{ip}^g \leq 0 \quad (\forall P \in P, \forall i \in V_p) \quad (3.37)$$

A technology is acquired only if it used to produce at least one product :

$$W_i^g - \sum_{p \in M_i} Q_{ip}^g \leq 0 \quad (\forall i \in S, \forall g \in G) \quad (3.38)$$

A site is selected if it is open for one product at least :

$$A_i - \sum_{p \in M_i \cup R_i} Y_{ip} \leq 0 \quad (\forall i \in S \cup V) \quad (3.39)$$

3.10 References

- Andersson, J. (1999) A survey of multiobjective optimization in engineering design. Linköping, Sweden, Department of Mechanical Engineering, Linköping University.
- Cohon, J. L. (1978) Multiobjective programming and planning, New York, Academic Press.

- Dotoli, M., Fanti, M. P., Meloni, C. and Zhou, M. C. (2005) A multi-level approach for network design of integrated supply chains. *International Journal of Production Research*, 43, 4267-4287.
- Facanha, C. and Horvath, A. (2007) Evaluation of Life-Cycle Air Emission Factors of Freight Transportation. *Environmental Science & Technology*, 41, 7138-7144.
- Ferretti, I., Zanoni, S., Zavanella, L. and Diana, A. (2007) Greening the aluminium supply chain. *International Journal of Production Economics*, 108, 236-245.
- Frota Neto, J. Q., Bloemhof-Ruwaard, J. M., van Nunen, J. A. E. E. and van Heck, E. (2008) Designing and evaluating sustainable logistics networks. *International Journal of Production Economics*, 111, 195-208.
- Government of Canada (2008) Turning the Corner : Regulatory Framework for Industrial Greenhouse Gas Emissions.
- Guillen-Gosalbez, G. and Grossmann, I. E. (2009) Optimal design and planning of sustainable chemical supply chains under uncertainty. *AIChE Journal*, 55, 99-121.
- Jayaraman, V., Guide, V. D. R. and Srivastava, R. (1999) A closed-loop logistics model for remanufacturing. *Journal of the Operational Research Society*, 50, 497-508.
- Johnson, E. and Heinen, R. (2004) Carbon trading : time for industry involvement. *Environment International*, 30, 279-288.
- Karan, C. and Philippe, A. (2008) State and trends of the carbon market 2008. Washington, D.C., The World Bank.
- Kettani, O., Aouni, B. and Martel, J.-M. (2004) The double role of the weight factor in the goal programming model. *Computers & Operations Research*, 31, 1833-1845.
- Labatt, S. and White, R. R. (2007) Carbon finance : the financial implications of climate change, Hoboken, N.J., John Wiley & Sons.
- Luo, Y., Zhou, M. and Caudill, R. J. (2001) An integrated E-supply chain model for agile and environmentally conscious manufacturing. *IEEE/ASME Transactions on Mechatronics*, 6, 377-386.
- Nari, V., Jhana, S. and Robert, S. (2008) Supply Chain Network Design : Architecting A Green Future. Boston, Aberdeen Group.

- Peace, J. and Juliani, T. (2009) The coming carbon market and its impact on the American economy. *Policy and Society*, 27, 305-316.
- Pistikopoulos, E. N. and Hugo, A. (2005) Environmentally conscious long-range planning and design of supply chain networks. *Journal of Cleaner Production*, 13, 1428-48.
- Ramudhin, A., Chaabane, A., Kharoune, M. and Paquet, M. (2008) Carbon Market Sensitive Green Supply Chain Network Design. IEEE International Conference on Industrial Engineering and Engineering Management, 2008. IEEM 2008.
- Seuring, S. and Muller, M. (2008) From a literature review to a conceptual framework for sustainable supply chain management. *Journal of Cleaner Production*, 16, 1699-1710.
- Sheu, J.-B., Chou, Y.-H. and Hu, C.-C. (2005) An integrated logistics operational model for green-supply chain management. *Transportation Research Part E : Logistics and Transportation Review*, 41, 287-313.
- Srivastava, S. K. (2007) Green supply-chain management : A state-of-the-art literature review. *International Journal of Management Reviews*, 9, 53-80.

CHAPTER 4

ARTICLE #3 «DESIGN OF SUSTAINABLE SUPPLY CHAINS UNDER THE EMISSION TRADING SCHEME»

Amin Chaabane, Amar Ramudhin, Marc Paquet

Département de génie de la production automatisée, École de Technologie Supérieure,
1100 Notre-Dame Ouest, Montréal, Québec, Canada H3C 1K3

Accepted for publication in the International Journal Of Production Economics

(doi:10.1016/j.ijpe.2010.10.025)

Résumé

L'augmentation des préoccupations environnementales avec les législations sur le respect du cadre réglementaire sur les émissions en gazes à effet de serre obligent les industries à prendre un nouveau regard sur l'impact de leurs opérations de chaîne d'approvisionnement sur l'environnement. Cet article présente un modèle de programmation linéaire en nombres entiers multi-période pour la conception de la chaîne d'approvisionnement durable qui tient compte des principes d'analyse du cycle de vie (ACV), en plus des contraintes classiques de bilan matières à chaque nœud de la chaîne d'approvisionnement. En effet, le cadre établit une distinction entre déchets solides et liquides, ainsi que les émissions de gaz dues à différents processus de production et de transport. Le cadre est utilisé pour évaluer les compromis entre les objectifs économiques et environnementaux en vertu de divers coûts et les stratégies d'exploitation dans l'industrie de l'aluminium. Les résultats suggèrent que la législation actuelle sur le carbone doit être renforcées et harmonisées à l'échelle mondiale afin de conduire une véritable stratégie de l'environnement. En outre, le modèle montre que des stratégies efficaces de gestion du carbone aideront les décideurs à atteindre les objectifs de la durabilité d'une manière rentable.

Abstract

Increasing in environmental concerns together with legislations are forcing industries to take a fresh look at the impact of their supply chain operations on the environment. This paper introduces a multi-period mixed-integer linear programming based framework for sustainable supply chain design that considers life cycle assessment (LCA) principles in addition to the traditional material balance constraints at each node in the supply chain. Indeed, the framework distinguishes between solid and liquid wastes, as well as gaseous emissions due to various production processes and transportation systems. The framework is used to evaluate the trade-offs between economic and environmental objectives under various cost and operating strategies in the aluminum industry. The results suggest that current legislation and Emission Trading Schemes (ETS) must be strengthened and harmonized at the global level in order to drive a meaningful environmental strategy. Moreover, the model demonstrates that efficient carbon management strategies will help decision makers to achieve sustainability objectives in a cost-effective manner.

4.1 Introduction

Supply chain network design attempts to define the best supply chain configuration that enables an organization to maximize its long-term economic performance. Typically, the decisions cover two planning levels: (1) strategic decisions on sourcing, production (opening or closing of facilities), distribution and sales; (2) tactical decisions on supply network planning affecting the flow of goods through the network. Flexibility, robustness and responsiveness are some of the strategies that have been used to adapt to dynamic changes in the supply chain environment (Sabri and Beamon, 2000). But, unfortunately the pursuit of short term profitability is still recognized as the one of the major drivers for managerial decisions and this, among other things, has contributed to the slowdown in the current global economy.

Nowadays, given the constraints relative to the availability of non-renewable resources (metal, oil, etc.), enterprises are more than ever obliged to rethink their strategies to ensure

the sustainability of their operations. Closed-loop supply chains are one of the options that are being considered (Pochampally et al., 2009, Srivastava, 2008, Barker and Zabinsky, 2008, Lieckens and Vandaele, 2007). Other avenues being studied include different actions related to one or more phases of the product life cycle such as product design (Hugo and Pistikopoulos, 2005), production planning and control for remanufacturing (Jayaraman et al., 1999, Luo et al., 2001), inventory management (Ferretti et al., 2007), product recovery (Jayaraman, 2006), reverse logistics (Sheu et al., 2005, Sheu, 2008) and carbon emissions reduction (Ramudhin et al., 2008).

However, these actions may not be enough to guarantee long-term sustainability. Indeed, recovery of used products and re-processing (remanufacturing, recycling, disposal, incineration, etc.) might not only increase operating costs but also contribute to an increase in greenhouse gases (GHG) emissions which defeats long-term sustainability. Sustainable development recognizes the interdependence between three dimensions: the economic, the environmental and the social performances of an organization. An integrated approach that links supply chain decisions to the three pillars of sustainability is advocated.

Sustainable supply chain design (Frota Neto et al., 2008) is a new emerging approach that arose in response to this situation and tries to embed economic, environmental as well as societal decisions in supply chains at design time. The objective of the methodology proposed in this paper is to present a formal decision model that considers the important dimensions of sustainability throughout the supply chain life cycle.

4.2 Literature review

Traditionally, the main objective of optimization models used in strategic network design focused on the economic aspect of supply chains (Goetschalcks and Fleischmann, 2008). However, more recently there has been a growing awareness about environmental issues. The first proposals tried to integrate such considerations at the plant level. The main drawback of these approaches is that it may result in solutions that reduce the negative environmental impact somewhere in the supply chain at the expense of increasing it somewhere elsewhere.

Life Cycle Assessment (LCA) methodology has been proposed in response to this situation (De Benedetto and Klemes, 2009). LCA is a process for evaluating the environmental impacts associated with a product, process or activity. It identifies and quantifies the energy and materials used and the waste released to the environment, and evaluates and implements opportunities for environmental improvements. The assessment covers the entire life cycle of the product, process or activity, including extracting and processing raw materials, manufacturing, transportation and distribution, reuse and maintenance, recycling and final disposal.

Hugo and Pistikopoulos (2005) present a mathematical programming-based methodology with explicit inclusion of life cycle assessment (LCA) criteria as part of the strategic investment decisions related to the design and planning of supply chain networks. Nagurney et al. (2006) develop a supply chain model in which the manufacturers can produce homogeneous product in different manufacturing plants with distinct environmental emissions. Frota Neto et al. (2008) develop a framework for the design and evaluation of sustainable logistic networks where activities affecting the environment and cost efficiency in logistic networks are considered. Guillen-Gosalbez and Grossmann (2009) present a supply chain network design model to determine the supply chain configuration along with the planning decisions that maximizes the net present value and minimizes environmental impact. The model includes structural and planning decisions.

While the LCA principle has been successfully applied to design new products and processes that reduce environmental damage (global warming, ozone depletion, acidification, toxicity, etc.), limited work has been conducted on the development of decision making models that integrate both LCA principles and supply chain management principles (Seuring and Muller, 2008). In addition, few studies have addressed the impact of integrating external control mechanisms (government regulation, take-back legislation, GHG emissions, and carbon taxes, carbon markets, etc.) on sustainable supply chain management practices. For instance, Nagurney et al. (2006) is one of the first studies that addresses carbon taxes in the electric power supply chains (Nagurney et al., 2006). Subramanian et al. (2008) propose an approach to integrate environmental consideration within a managerial decision making framework

(Subramanian et al., 2008). A non-linear mathematical programming model is introduced that allows the incorporation of traditional operations planning considerations (capacity, production and inventory) with environmental considerations (design, production, and end-of-life). Decisions on the number of carbon credits purchased and sold in different periods are added under the limitation of carbon emissions.

Ramudhin et al. (2010) are the first to propose a carbon market sensitive strategic planning model for sustainable supply chain network design. They show that considerations of internal and external control mechanisms are of great importance to decision makers when designing sustainable supply chains. This paper extends the model presented in Ramudhin et al. (2010) by consideration of the LCA methodology to establish successful sustainable supply chains over time. The capability of the model is illustrated by an example of strategic planning in the aluminum supply chain.

4.3 Problem statement and methodology

Among the different approaches available to assess the environmental impact of processes and organizations, the LCA method seems to be the most promising. It aggregates the results of different aspects of environmental studies including GHG emissions that are recognized as the most harmful elements to the environment and responsible for climate change. GHG emissions are calculated based on emission factors and converted to carbon dioxide equivalent quantity (CO₂e).

Many countries are implementing various mechanisms to reduce GHG emissions including incentives or mandatory targets to reduce carbon footprint. Carbon taxes and carbon markets (emissions trading) are recognized as the most cost-effective mechanisms (Labatt and White, 2007). The basic idea is to put a price tag on carbon emissions and create new investment opportunities to generate a fund for green technology development (Bayon et al., 2007, Labatt and White, 2007). There are already a number of active carbon markets for GHG emissions such as the European Union Emission Trading Scheme (or EU ETS) in Europe, the largest multi-national GHG emissions trading scheme in the world, the New Zealand

Emissions Trading Scheme (NZ ETS) in New Zealand, the Chicago Climate Exchange in United State (Peace and Juliani, 2009, Johnson and Heinen, 2004), and more recently the Montreal Climate Exchange in Canada.

Measuring and assessing carbon emissions becomes then an important step that can be achieved by LCA techniques and software (Rice et al., 1997). However, compliance with the environmental regulation of carbon emissions in a cost-effective manner is challenging. Thus, supply chain network design model had been revised to include the additional cost due to GHG emissions at all levels of the supply chain and social variables affecting the quality of life of the community in which the supply chain operates.

As shown in Figure 4.1, an LCA based approach is necessary in order to establish the link between the critical inputs (raw material, energy, human, used product, etc.) and the output (products, GHG emissions, waste) at each node of the network over its entire life cycle. Strategic planning of sustainable supply chains should include the recovery of products decisions as well as carbon management strategies in order to be in compliance with the different environmental regulations. Thus, the supply chain performance should be evaluated based on the economic (cost and profit), the environmental (carbon emissions, recycling performance, waste management and energy use), and the social performances (quality of life, noise, etc.).

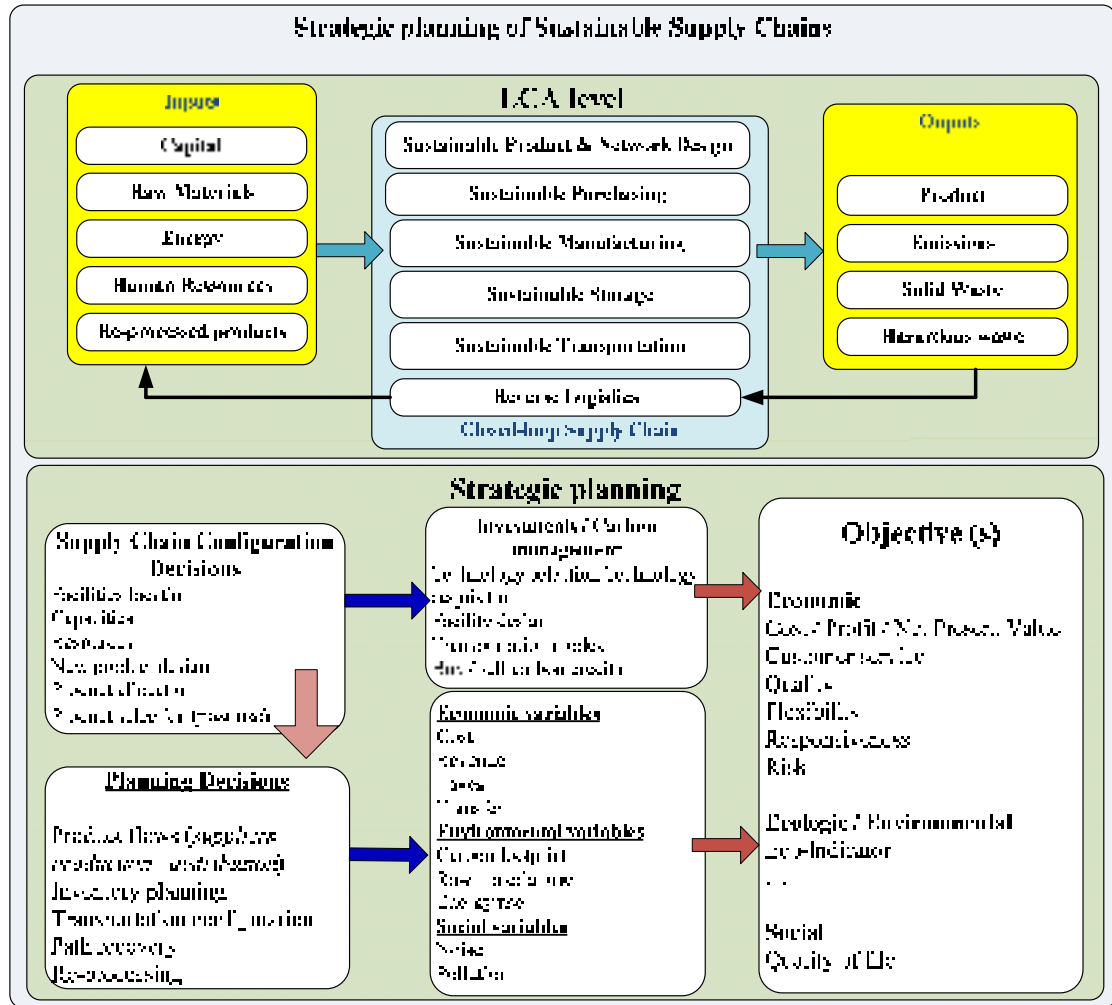

Figure 4.1 An LCA approach to support sustainable supply chain design.

4.4 Model development

This section describes a generic mathematical model to help decision makers in the design and planning of sustainable supply chain based on the LCA methodology. The model establishes the link with the emission trading scheme to achieve sustainability objectives in a cost-effective manner under the different legislations that caps GHG emissions and impose mandatory targets for recycling products at the end of their life. Although supply chain sustainability recognizes the link between the economic, ecological, and social performance, an examination of social performances (labour equity, healthcare, safety, philanthropic

commitment) shows that they are dependent on the context of operation of the supply chain (type of the industry), the government policies, and cultural norms. Thus, without loss of generality, we do not include the social performance in the mathematical formulation.

4.4.1 Assumptions

Figure 4.2 shows the structure of the global supply chain. The sites are located in different zones $z \in Z$. A set of potential suppliers $n \in S$ can supply raw materials $p \in P^{MP}$ to a set of sub-contractors and plants $n \in F$ to manufacture products $p \in P^{PF}$. The latter can be distributed through a set of potential distribution centers $n \in D$. Final products are shipped from the distribution centers to different customers or markets $n \in C$. Also available are different recycling centers $n \in R$ for the processing of used products that can be returned to different stages in the supply chain. Let N denotes the set of the different nodes of the supply chain network, $N = S \cup F \cup D \cup C \cup R$.

At each production center, a set of potential technologies $h \in H$ is available for use. Each of these technologies needs some inputs (energy, liquid, solid, gazes, etc.) $i \in I$, in addition to materials and generate different outputs (liquid, solid, gazes) $o \in O$. Different transportation modes $m \in M$ are used for the shipment of products between nodes (suppliers, production units, distribution centers, and recycling units). Each transportation mode needs some inputs (e.g. energy and gazes) and may generate some wastes (output). The main objective of the model is to support sustainable supply chain network design over a long-term period of time $t \in T$.

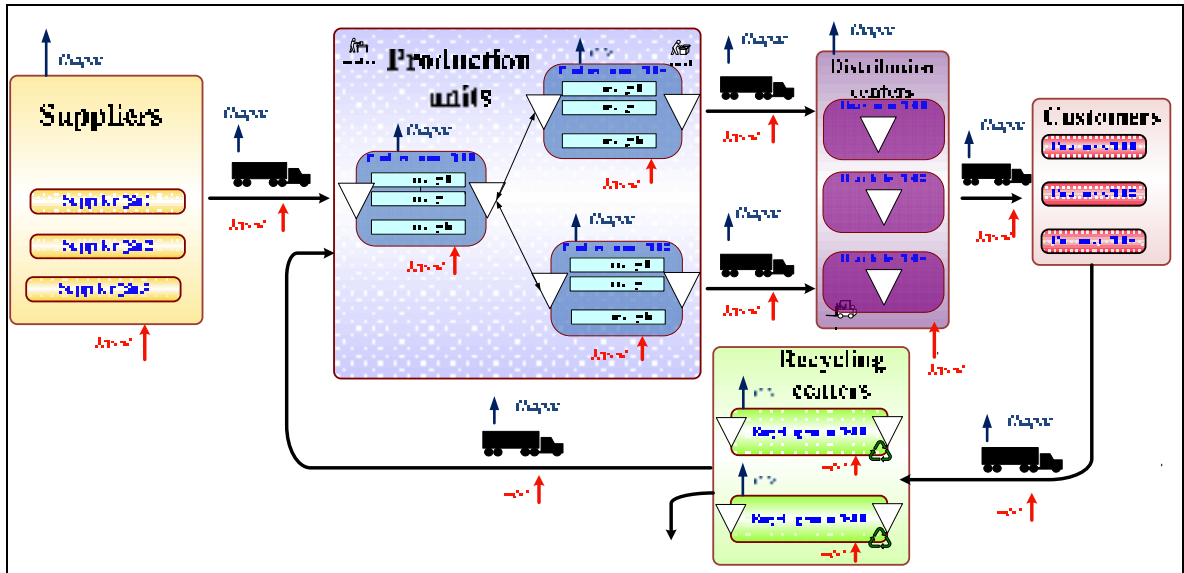

Figure 4.2 Closed-loop supply chain network structure.

Before the description of the detailed model, some basic elements about modeling techniques that have been used are explained. Generally, we define two types of nodes (production unit and recycling center). For a production unit, one or several technologies will be available for manufacturing activities. The production is based on a bill of material that indicates the quantity of raw material or components required to manufacture components or final products. The potential technologies available differ in terms of acquisition and operation costs as well as inputs consumption and output emissions. Figure 4.3 summarize the situation.

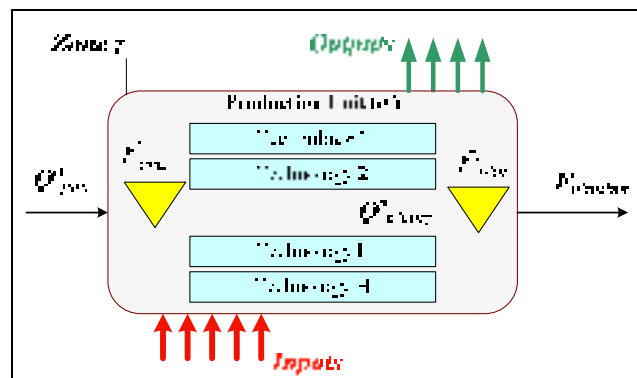

Figure 4.3 Characteristics of a production unit.

For a recycling center (Figure 4.4), we consider that a certain percentage of products are recovered by the company. To simplify the calculation, we consider that is proportional to the demand at each period. Thus, we assume that for each period, there is a quantity of used products collected and delivered to recycling centers. Using a bill of material of disassembly, the product is disassembled. Good recycled components and raw materials are reintegrated in production units. The non-useable products (components and materials) are destroyed through the disposal process.

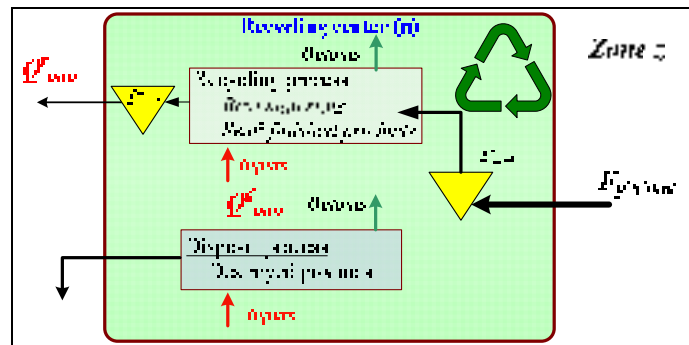

Figure 4.4 Characteristics of a production unit.

4.4.2 Decision variables

To achieve the objective of sustainability and understand the impact of different control parameters on the decision process, several decisions touching various aspects of the supply chain must be taken into account. They are :

a) Decisions related to sites (plants and recycling centers) location

$Y_{nz}^l =$ Binary variable takes a value of 1 if site $n \in F \cup D \cup R$ is located at zone $z \in Z$, 0 otherwise.

b) Decisions related to production units

$Q_{pnt}^n =$ Quantity of product $p \in P^{MP} \cup P^{PF}$ necessary in production unit $n \in F$ during time period $t \in T$.

Q_{phntz}^p = Quantity of product $p \in P^{PF}$ manufactured / assembled using technology $h \in H$ at production unit $n \in F$ during time period $t \in T$ at zone $z \in Z$.

I_{pnt}^{fi} = The inventory level of input product $p \in P^{MP} \cup P^{PF}$ at unit production $n \in F$ during time period $t \in T$.

I_{pnt}^{fo} = The inventory level of output product $p \in P^{PF}$ at unit production $n \in F$ during time period $t \in T$.

Y_{pnt}^s = Binary variable takes a value of 1 if supplier $n \in S$ is selected for supplying raw material $p \in P^{MP}$ during time period $t \in T$, 0 otherwise.

Y_{nt}^f = Binary variable takes a value of 1 if production unit $n \in F$ is operational during time period $t \in T$, 0 otherwise.

Y_{hnt}^h = Binary variable takes a value of 1 if technology $h \in H$ is selected at production unit $n \in F$ during time period $t \in T$, 0 otherwise.

Y_{phnt}^p = Binary variable takes a value of 1 if product $p \in P^{PF}$ is manufactured/assembled using technology $h \in H$ at production unit $n \in F$ during time period $t \in T$, 0 otherwise.

c) Decisions related to distribution centers

Y_{nt}^d = Binary variable takes a value of 1 if distribution center $n \in D$ is operational during time period $t \in T$, 0 otherwise.

I_{pnt}^d = The inventory level of product $p \in P^{PF}$ at distribution centre $n \in D$ during time period $t \in T$.

d) Decisions related to recycling centers

$Y_{nt}^r =$ Binary variable takes a value of 1 if recycling center $n \in R$ is operational during time period $t \in T$, 0 otherwise.

$Q_{pntz}^a =$ Quantity of product $p \in P^{PF}$ refurbished at recycling center $n \in R$ during time period $t \in T$ at zone $z \in Z$.

$Q_{pntz}^r =$ Quantity of raw material $p \in P^{MP}$ recycled at recycling center $n \in R$ during time period $t \in T$ at zone $z \in Z$.

$Q_{pntz}^d =$ Quantity of product $p \in P^{MP} \cup P^{PF}$ disposed at recycling center $n \in R$ during time period $t \in T$ at zone $z \in Z$.

$I_{pnt}^{ri} =$ The inventory level of input of product $p \in P^{PF}$ at recycling center $n \in R$ during time period $t \in T$.

$I_{pnt}^{ro} =$ The inventory level of output of recycled material $p \in P^{MP} \cup P^{PF}$ at recycling center $n \in R$ during time period $t \in T$.

e) Decisions related to transportation

$F_{pnn'mt} =$ Quantity of product $p \in P^{MP} \cup P^{PF}$ processed from node $n \in N$ to node $n' \in N$ using transportation mode $m \in M$ during time period $t \in T$.

$Y_{mm't}^t =$ Binary variable takes a value of 1 if transportation mode $m \in M$ is selected between node $n \in N$ and node $n' \in N$ during time period $t \in T$, 0 otherwise.

f) Decisions related to carbon management

CC_{tz}^+ = Credits purchased during time period $t \in T$ at zone $z \in Z$.

CC_{tz}^- = Credits sold during time period $t \in T$ at zone $z \in Z$.

Decisions on (a), (b), (c), (d) and (e) are related to the supply chain network configuration and aggregate planning, while decisions on (f) determine the strategy to put in place for GHG emissions control. The problem can be viewed as a multi-objective model where the economic objective function, denoted by F_1 , evaluates the total logistic cost and the environmental objective function, denoted by F_2 , evaluates carbon emissions resulting from operation strategies, manufacturing, and transportation activities. Using the Intergovernmental Panel for Climate Change (IPCC) guidelines and other environmental data, the global warming potential (GWP) for each activity of the supply chain is expressed in terms of carbon dioxide equivalent quantity (CO₂e). Emissions are assumed to be linearly proportional to manufacturing, transportation, and usage.

4.5 Model formulation

This section describes the linear programming model that considers the critical aspects for the design and strategic planning of sustainable supply chains. The choice of multi-objective linear programming (MOLP) as a methodology to investigate this problem is basically because it helps to find the different strategic decisions (explained in the previous framework: see Figure 4.1) of linear objective functions and a single decision maker or a decision making body (the focal company) that guarantee a trade-off with respect to some linear constraints. Different parameters are necessary to describe the model.

4.5.1 Monetary parameters

a_{nz}^l = Fixed cost for locating site $n \in F \cup D \cup R$ at zone $z \in Z$.

a_{pnt}^s = Fixed cost due to acquisition of raw material $p \in P^{MP}$ from supplier $n \in S$ during period $t \in T$. This represents the cost of development of long term partnership with

the supplier to guarantee a good service level (e.g. investing on information technology and communication).

c_{pnt}^{af} = Purchasing cost of one unit of raw material $p \in P^{MP}$ from supplier $n \in S$ during time period $t \in T$.

c_{pnt}^{ar} = Purchasing cost of one unit of recycled material $p \in P^{MP} \cup P^{PF}$ from recycling centre $n \in R$ during time period $t \in T$.

a_{nt}^f = Fixed cost associated with the operation of production unit $n \in F$ during time period $t \in T$.

a_{hnt}^h = Fixed cost associated with the implementation of a new technology $h \in H$ in production unit $n \in F$ during time period $t \in T$.

a_{phnt}^p = Production cost of one unit of product $p \in P^{PF}$ using technology $h \in H$ in production unit $n \in F$ during time period $t \in T$.

c_{phntz}^p = Variable cost associated with the configuration of technology $h \in H$ used in production unit $n \in F$ to manufacture/assemble product $p \in P^{PF}$ during time period $t \in T$ at zone $z \in Z$.

c_{pnt}^{fi} = Inventory carrying cost of input product $p \in P^{MP} \cup P^{PF}$ at production unit $n \in F$ during time period $t \in T$.

c_{pnt}^{fo} = Inventory carrying cost of output product $p \in P^{PF}$ at production unit $n \in F$ during time period $t \in T$.

a_{nt}^d = Fixed cost associated with the operation of distribution centre $n \in D$ during time period $t \in T$.

c_{pnt}^d = Inventory carrying cost of product $p \in P^{PF}$ at distribution centre $n \in D$ during time period $t \in T$.

a_{nt}^r = Fixed cost associated with the operation of recycling centre $n \in R$ during time period $t \in T$.

c_{pnt}^{rc} = Purchasing cost of one unit of used product $p \in P^{PF}$ at recycling centre $n \in R$ during time period $t \in T$.

c_{pntz}^r = Refurbishing cost of one unit of used product $p \in P^{PF}$ at recycling centre $n \in R$ during time period $t \in T$ at zone $z \in Z$.

c_{pntz}^{dr} = Disposal cost of used product $p \in P^{PF}$ at recycling centre $n \in R$ during time period $t \in T$ at zone $z \in Z$.

c_{pnt}^{ri} = Inventory carrying cost of product $p \in P^{PF}$ at recycling centre $n \in R$ during time period $t \in T$.

c_{pnt}^{ro} = Inventory carrying cost of raw material $p \in P^{MP}$ at recycling centre $n \in R$ during time period.

$a_{nn',mt}^t$ = Fixed cost associated with the establishment of a transportation link between node $n \in N$ and node $n' \in N$ using mode $m \in M$ during time period $t \in T$.

$c_{pnn',mt}^t$ = Transportation cost of one unit of product $p \in P^{MP} \cup P^{PF}$ between node $n \in N$ and node $n' \in N$ using transportation mode $m \in M$ during time period $t \in T$

v_{it} = Usage cost of input $i \in I$ during time period $t \in T$.

u_{ot} = Emission cost of output $o \in O$ during time period $t \in T$.

A_{tz}^{cc} = The market price of buying a credit during time period $t \in T$ at zone $z \in Z$.

V_{tz}^{cc} = The market price of selling a credit during time period $t \in T$ at zone $z \in Z$.

4.5.2 Technical parameters

CF_{iph}^p = Utilization factor of input $i \in I$ to manufacture / assemble $p \in P^{PF}$ using technology $h \in H$.

CF_{ipn}^r = Utilization factor of input $i \in I$ during the recycling process of product $p \in P^{PF}$ at recycling center $n \in R$.

CF_{ipn}^d = Utilization factor of input $i \in I$ during the destruction process of product $p \in P^{PF}$ at recycling center $n \in R$.

- CF_{im}^t = Utilization factor of input $i \in I$ for using transportation mode $m \in M$.
- EF_{oph}^p = Emission inventory of output $o \in O$ to manufacture / assemble product $p \in P^{PF}$ using technology $h \in H$.
- EF_{opn}^r = Emission inventory of output $o \in O$ during the recycling process of product $p \in P^{PF}$ at recycling center $n \in R$.
- EF_{opn}^d = Emission inventory of output $o \in O$ during the destruction process of product $p \in P^{PF}$ at recycling center $n \in R$.
- EF_{om}^t = Emission inventory of output $o \in O$ for using transportation mode $m \in M$
- λ_{pnt} = Capacity of supplier $n \in S$ for raw material $p \in P^{MP}$ during time period $t \in T$.
- $\varphi_{pp'}$ = Utilization factor of product $p \in P^{MP} \cup P^{PF}$ used in product $p' \in P^{PF}$.
- q_{phnt}^p = Upper bound on product $p \in P^{PF}$ manufactured / assembled using technology $h \in H$ at production unit $n \in F$ during time period $t \in T$.
- i_{pnt}^{fi} = Inventory capacity for input product $p \in P^{MP} \cup P^{PF}$ at site $n \in F$ during period $t \in T$.
- i_{pnt}^{fo} = Inventory capacity for output product $p \in P^{PF}$ at node $n \in F$ during period $t \in T$.
- i_{pnt}^d = Inventory capacity for final products $p \in P^{PF}$ at node $n \in D$ during period $t \in T$.
- χ_{nt} = Distribution capacity at distribution center $n \in D$ during time period $t \in T$.
- d_{pnt} = Demand of product $p \in P^{PF}$ for customer $n \in C$ during time period $t \in T$.
- δ_{pt} = Return rate target for product $p \in P^{PF}$ during time period $t \in T$.
- i_{pnt}^{ri} = Inventory capacity of recovered products $p \in P^{PF}$ at recycling centers $n \in R$ during period $t \in T$.
- θ_{pntz} = Recycling performance factor for product $p \in P^{PF}$ at recycling centre $n \in R$ during time period $t \in T$ at zone $z \in Z$.
- $\phi_{pp'}$ = Conversion factor of recycled material $p \in P^{MP} \cup P^{PF}$ from product $p' \in P^{PF}$.

q_{pnt}^r = Capacity of recycling centre $n \in R$ for product $p \in P^{PF}$ during time period $t \in T$.

$c_{m'mt}$ = Capacity of transportation between node $n \in N$ and node $n' \in N$ when using transportation mode $m \in M$ during time period $t \in T$.

4.5.3 Carbon management parameters

CO_i^{in} = Characterization factor used to convert input $i \in I$ to carbon dioxide equivalent (CO_2e) .

CO_o^{out} = Characterization factor used to convert output $o \in O$ to carbon dioxide equivalent (CO_2e) .

L_{tz}^{COP} = Limit on the number of credits to purchase during compliance time period $t \in T$ at zone $z \in Z$.

L_{tz}^{COS} = Limit on the number of credits to sold during compliance time period $t \in T$ at zone $z \in Z$.

$L_{tz}^{CO_2e}$ = Aggregated limit in term of carbon dioxide equivalent (CO_2e) emissions during compliance time period $t \in T$ at zone $z \in Z$.

4.5.4 Economic objective (F₁)

The strategic sustainable supply chain network design described before has the objective to find a trade-off solution between the economic and the environmental performance under the different regulations that caps GHG emissions and impose constraints related producer responsibility at the end of the production life cycle. The economic objective is evaluated by the total logistic cost. The environmental performance is evaluated by the total emissions of GHG.

The economic dimension includes different costs:

- Location cost (denoted ZC): which are the costs to locate production, distribution and recycling centers at the different regions :

$$\sum_{n \in F \cup D \cup R} \sum_{z \in Z} a_{nz}^l Y_{nz}^l$$

- Supply costs (denoted SC): which are the costs to acquire materials :

Fixed cost to establish contracts with suppliers:

$$\sum_{p \in P^{MP}} \sum_{n \in S} \sum_{t \in T} a_{pnt}^s Y_{pnt}^s$$

Variable cost for raw materials acquisition:

$$\sum_{p \in P^{MP}} \sum_{n \in S} \sum_{n' \in F} \sum_{m \in M} \sum_{t \in T} c_{pnt}^{gf} F_{pnm't}$$

Recycled materials acquisition:

$$\sum_{p \in P^{MP}} \sum_{n \in R} \sum_{n' \in F} \sum_{m \in M} \sum_{t \in T} c_{pnt}^{ar} F_{pnm't}$$

- Production costs (denoted PC): which are the costs to manufacture products:

Fixed cost for operating production units:

$$\sum_{n \in F} \sum_{t \in T} a_{nt}^f Y_{nt}^f$$

Fixed cost for technology acquisition:

$$\sum_{h \in H} \sum_{n \in F} \sum_{t \in T} a_{hnt}^h Y_{hnt}^h$$

Fixed cost for production line configuration:

$$\sum_{p \in P^{PF}} \sum_{h \in H} \sum_{n \in F} \sum_{t \in T} a_{phnt}^p Y_{phnt}^p$$

Variable cost for manufacturing:

$$\sum_{p \in P^{PF}} \sum_{h \in H} \sum_{n \in F} \sum_{t \in T} \sum_{z \in Z} c_{phntz}^p Q_{phntz}^p$$

Inventory cost of materials:

$$\sum_{p \in P^{MP}} \sum_{n \in F} \sum_{t \in T} c_{pnt}^{fi} I_{pnt}^{fi}$$

Inventory cost of products:

$$\sum_{p \in P^{PF}} \sum_{n \in F} \sum_{t \in T} c_{pnt}^{fo} I_{pnt}^{fo}$$

- Distribution costs (denoted DC) : which are the costs to distribute products:

Fixed cost for operating distribution centers:

$$\sum_{n \in D} \sum_{t \in T} a_{nt}^d Y_{nt}^d$$

Variable cost for material handling products:

$$\sum_{p \in P^{PF}} \sum_{n \in D} \sum_{t \in T} c_{pnt}^d I_{pnt}^d$$

- Reverse logistics costs (denoted RC): which are the costs to recycle and dispose products:

Fixed cost for operating recycling centers:

$$\sum_{n \in R} \sum_{t \in T} a_{nt}^r Y_{nt}^r$$

Cost of recovery of used products:

$$\sum_{p \in P^{PR}} \sum_{n \in R} \sum_{n' \in C} \sum_{m \in M} \sum_{t \in T} c_{pnt}^{rc} F_{pn'nm}^r$$

Variable cost of recycling used products:

$$\sum_{p \in P^{PF}} \sum_{n \in R} \sum_{t \in T} \sum_{z \in Z} c_{pntz}^r Q_{pntz}^r$$

Variable cost for disposal of used products:

$$\sum_{p \in P^{PF}} \sum_{n \in R} \sum_{t \in T} \sum_{z \in Z} c_{pntz}^{dr} Q_{pntz}^d$$

Inventory cost for recovered used products:

$$\sum_{p \in P^{PF}} \sum_{n \in R} \sum_{t \in T} c_{pnt}^{ri} I_{pnt}^{ri}$$

Inventory cost for recycled products:

$$\sum_{p \in P^{MP} \cup P^{PF}} \sum_{n \in R} \sum_{t \in T} c_{pnt}^{ro} I_{pnt}^{ro}$$

- Transportation cost (denoted TC): which are the costs to move products:

Fixed cost for transportation links between nodes:

$$\sum_{n \in N} \sum_{n' \in N} \sum_{m \in M} \sum_{t \in T} a_{nn'mt}^t Y_{nn'mt}^t$$

Variable cost for transportation:

$$\sum_{p \in P^{MP} \cup P^{PF}} \sum_{n \in N} \sum_{n' \in N} \sum_{m \in M} \sum_{t \in T} c_{pnn'mt}^t F_{pnn'mt}$$

- LCA based cost (denoted LC) : We consider that the company will identify some strategic input costs (water, oil, energy, etc.) that need to be considered in economic objective function. Also, some outputs (waste, co-products, etc.) need further treatment and there are also some related costs. Let's denote C_{it} the consumption of the input $i \in I$ during period $t \in T$:

$$C_{it} = \left(\sum_{p \in P^{PF}} \sum_{h \in H} \sum_{n \in F} \sum_{z \in Z} CF_{iph}^p Q_{phntz}^p \right) + \left(\sum_{p \in P^{PF}} \sum_{n \in R} \sum_{z \in Z} CF_{ipn}^r Q_{pntz}^r \right) + \left(\sum_{p \in P^{PF}} \sum_{n \in R} \sum_{z \in Z} CF_{ipn}^d Q_{pntz}^d \right) + \left(\sum_{p \in P} \sum_{n \in N} \sum_{n' \in N} \sum_{m \in M} CF_{im}^t F_{pnn'mt} \right) \quad \forall i \in I, \forall t \in T \quad (4.1)$$

Let's denote E_{ot} the emission of the output $o \in O$ during period $t \in T$:

$$E_{ot} = \left(\sum_{p \in P^{PF}} \sum_{h \in H} \sum_{n \in F} \sum_{z \in Z} EF_{oph}^p Q_{phntz}^p \right) + \left(\sum_{p \in P^{PF}} \sum_{n \in R} \sum_{z \in Z} EF_{opn}^r Q_{pntz}^r \right) + \left(\sum_{p \in P^{PF}} \sum_{n \in R} \sum_{z \in Z} EF_{opn}^d Q_{pntz}^d \right) + \left(\sum_{p \in P} \sum_{n \in N} \sum_{n' \in N} \sum_{m \in M} EF_{om}^t F_{pnn'mt} \right) \quad \forall o \in O, \forall t \in T \quad (4.2)$$

Thus, the cost of using inputs and treating outputs (if necessary) is:

$$\sum_{i \in I} \sum_{t \in T} v_{it} C_{it} + \sum_{o \in O} \sum_{t \in T} u_{ot} E_{ot}$$

- Carbon credit component (denoted CC): For many organizations and industrial sectors, the main emissions are greenhouse gases. Many companies have set voluntary targets in term of GHG emissions attributable to their supply chain or are subject to a new regulation that “caps” GHG emissions. Under an Emission trading Scheme (ETS), carbon dioxide (CO₂) is tradable. This system is based on the allocation of units to a company for exceeding its intensity-based GHG emissions reduction targets [1 credit = right to emit one metric ton of carbon dioxide equivalent (CO₂e)]. At the end of each compliance period, the emissions of the company will be verified. Each emitter must then offset its GHG emissions against its intensity-based GHG emissions reduction target established by the government. The discrepancy between the imposed target and the actual emissions

may be offset by, among other things, the purchase of units on the domestic market. In addition to internal reductions, large emitters will be able to buy units from the carbon market in order to ensure compliance with their GHG emissions reductions obligations. On the other hand, those companies with emissions less than the cap will have the possibility to sell credits in the carbon market and generate profit. Thus, “carbon management” consists of taking the decision on the most cost-effective strategy to be in compliance either with environmental regulation or with voluntary targets. Thus, the decision is to determine the number of credits purchased (A_{tz}^{CC}) in period $t \in T$ and the number of credits sold (V_{tz}^{CC}) in period $t \in T$.

$$CC = \sum_{t \in T} \sum_{z \in Z} CC_{tz}^- A_{tz}^{CC} - \sum_{t \in T} \sum_{z \in Z} CC_{tz}^+ V_{tz}^{CC} \quad (4.3)$$

In summary, the economic performance in Equation 4.4 is measured by the objective function \mathbf{F}_1 that should be minimized to ensure economic sustainability.

$$\mathbf{F}_1 = ZC + SC + PC + DC + RC + TC + LC + CC \quad (4.4)$$

4.5.5 Environmental objective (\mathbf{F}_2)

The second key objective to achieve sustainable supply chains is the evaluation and the optimization of the environmental impact (Equation 4.5). The determination of the environmental performance of a supply chain is not easy and might be different from one industry sector to another. However, the use of an LCA approach helps in the evaluation of the environmental performance of product, process, and service. To make it general, we aggregate the different impacts in term of GHG emissions (objective function \mathbf{F}_2) which are very important in our case (due to the link with ETS). Once again, GHG emissions should be minimized to ensure environmental sustainability.

$$\mathbf{F}_2 = \sum_{t \in T} \left(\sum_{o \in O} E_{ot} CO_o^{out} + \sum_{i \in I} C_{it} CO_i^{in} \right) \quad (4.5)$$

4.5.6 Constraints

Suppliers

Supplier's capacity

$$\sum_{n \in F} \sum_{m \in M} F_{pn'mt} \leq \lambda_{pnt} Y_{pnt}^s \quad \forall p \in P^{MP}, \forall n \in S, \forall t \in T \quad (4.6)$$

If the supplier is selected, it will stay operational for the whole planning horizon:

$$Y_{pnt}^s \geq Y_{pn(t-1)}^s \quad \forall p \in P^{MP}, \forall n \in S, \forall t \in T \quad (4.7)$$

Production units

Location of production units at zones

$$\sum_{p \in P^{PF}} \sum_{h \in H} \sum_{t \in T} Q_{phntz}^p \leq M Y_{nz}^l, \quad \forall n \in F, \forall z \in Z, M \text{ big number} \quad (4.8)$$

Raw material products usage

$$Q_{pnt}^n = \sum_{p' \in P^{PF}} \sum_{h \in H} \sum_{z \in Z} \varphi_{pp'} Q_{p'hntz}^p \quad \forall p \in P^{MP}, \forall n \in F, \forall t \in T \quad (4.9)$$

Products usage

$$\sum_{n' \in F \cup R} \sum_{m \in M} F_{pn'nmt} = \sum_{p' \in P^{PF}} \sum_{h \in H} \sum_{z \in Z} \varphi_{pp'} Q_{p'hntz}^p \quad \forall p \in P^{PF}, \forall n \in F, \forall t \in T \quad (4.10)$$

Capacity of production units

$$\sum_{z \in Z} Q_{phntz}^p \leq q_{phnt}^p Y_{phnt}^p \quad \forall p \in P^{PF}, \forall h \in H, \forall n \in F, \forall t \in T \quad (4.11)$$

Logic constraints: if a technology is not selected at a production unit, there is no need for configuration

$$Y_{phnt}^p \leq Y_{hnt}^h \quad \forall p \in P^{PF}, \forall n \in F, \forall h \in H, \forall t \in T \quad (4.12)$$

Logic constraints: if the production unit is not operational, there is no need to implement a technology in this facility

$$Y_{hnt}^h \leq Y_{nt}^f \quad \forall n \in F, \forall h \in H, \forall t \in T \quad (4.13)$$

Inventory of materials at production units

$$I_{pn(t-1)}^{fi} + \sum_{n' \in S} \sum_{m \in M} F_{pn'nmt} + \sum_{n' \in R} \sum_{m \in M} F_{pn'nmt} = I_{pnt}^{fi} + Q_{pnt}^n \quad \forall p \in P^{MP}, \forall n \in F, \forall t \in T \quad (4.14)$$

Initial inventory levels for products

$$I_{pn0}^{fi} = 0 \quad \forall p \in P^{MP} \cup P^{PF}, \forall n \in F \quad (4.15)$$

Inventory capacity constraints (raw material, components)

$$I_{pnt}^{fi} \leq i_{pnt}^{fi} \quad \forall p \in P^{MP} \cup P^{PF}, \forall n \in F, \forall t \in T \quad (4.16)$$

Inventory of output products

$$I_{pn(t-1)}^{fo} + \sum_{h \in H} \sum_{z \in Z} Q_{phntz}^p + \sum_{n' \in R} \sum_{m \in M} F_{pn'nmt} = I_{pnt}^{fo} + \sum_{n' \in F \cup D} \sum_{m \in M} F_{pnn'mt} \quad \forall p \in P^{PF}, \forall n \in F, \forall t \in T \quad (4.17)$$

Initial inventory levels for products

$$I_{pn0}^{fo} = 0 \quad \forall p \in P^{PF}, \forall n \in F \quad (4.18)$$

Inventory capacity constraints (components, products)

$$I_{pnt}^{fo} \leq i_{pnt}^{fo} \quad \forall p \in P^{PF}, \forall n \in F, \forall t \in T \quad (4.19)$$

If a production unit is operational, it will stay for the whole planning horizon:

$$Y_{nt}^f \geq Y_{n(t-1)}^f \quad \forall n \in F, \forall t \in T \quad (4.20)$$

If a technology is acquired, it is used for the whole horizon

$$Y_{hnt}^h \geq Y_{hn(t-1)}^h \quad \forall h \in H, \forall n \in F, \forall t \in T \quad (4.21)$$

Logic constraint for operating production units

$$Y_{nt}^f \leq \sum_{z \in Z} Y_{nz}^l \quad \forall n \in F, \forall t \in T \quad (4.22)$$

Limited number of production units per zone

$$\sum_{z \in Z} Y_{nz}^l \leq 1 \quad \forall n \in F \quad (4.23)$$

Distribution centers (DCs)

Inventory constraints at distribution centers

$$I_{pn(t-1)}^d + \sum_{n' \in F} \sum_{m \in M} F_{pn'nmt} = I_{pnt}^d + \sum_{n' \in C} \sum_{m \in M} F_{pnn'mt} \quad \forall p \in P^{PF}, \forall n \in D, \forall t \in T \quad (4.24)$$

Initial inventory levels for final products

$$I_{pn0}^d = 0 \quad \forall p \in P^{PF}, \forall n \in D \quad (4.25)$$

Inventory capacity constraints for final products at DCs

$$I_{pnt}^d \leq i_{pnt}^d \quad \forall p \in P^{PF}, \forall n \in D, \forall t \in T \quad (4.26)$$

Distribution center capacity

$$\sum_{n' \in F} \sum_{m \in M} F_{pn'nmt} + \sum_{n' \in C} \sum_{m \in M} F_{pnn'mt} \leq \chi_{nt} Y_{nt}^d \quad \forall p \in P^{PF}, \forall n \in D, \forall t \in T \quad (4.27)$$

If the production center is selected, it will stay operational for the whole planning horizon:

$$Y_{nt}^d \geq Y_{n(t-1)}^d \quad \forall n \in D, \forall t \in T \quad (4.28)$$

If the distribution center is not located in a specific region then it is not operational

$$Y_{nt}^d \leq \sum_{z \in Z} Y_{nz}^l \quad \forall n \in D, \forall t \in T \quad (4.29)$$

Limited number of distribution centers per zone

$$\sum_{z \in Z} Y_{nz}^l \leq 1 \quad \forall n \in D \quad (4.30)$$

Customers

Demand constraint

$$\sum_{n' \in D} \sum_{m \in M} F_{pn'nmt} = d_{pnt} \quad \forall p \in P^{PF}, \forall n \in C, \forall t \in T \quad (4.31)$$

Recycling centers

Location recycling centers at zones

$$\sum_{p \in P^{PF}} \sum_{z \in Z} (Q_{pntz}^r + Q_{pntz}^d + Q_{pntz}^a) \leq M Y_{nt}^l, \quad \forall n \in R, \forall t \in T, M \text{ big number} \quad (4.32)$$

Recovery of used products

$$\sum_{n \in C} \sum_{n' \in R} \sum_{m \in M} F_{pnm'mt} = \sum_{n \in N} \delta_{pt} d_{pnt} \quad \forall p \in P^{PF}, \forall t \in T \quad (4.33)$$

Initial inventory of products recovered at recycling centers:

$$I_{pnt0}^{ri} = 0 \quad \forall p \in P^{PF}, \forall n \in R \quad (4.34)$$

Inventory of used products at recycling centers

$$I_{pnt(t-1)}^{ri} + \sum_{n' \in C} \sum_{m \in M} F_{pnm'mt} = I_{pnt}^{ri} + \sum_{z \in Z} Q_{pntz}^a \quad \forall p \in P^{PF}, \forall n \in R, \forall t \in T \quad (4.35)$$

Inventory capacity of used products of recycling centers

$$I_{pnt}^{ri} \leq i_{pnt}^{ri} \quad \forall p \in P^{PF}, \forall n \in R, \forall t \in T \quad (4.36)$$

Disposal of non valuable products (sorting process)

$$Q_{pntz}^d = \theta_{pntz} Q_{pntz}^a \quad \forall p \in P^{PF}, \forall n \in R, \forall t \in T, \forall z \in Z \quad (4.37)$$

Reprocessing of good products

$$Q_{pntz}^r = \sum_{p' \in P^{PF}} \phi_{pp'} (1 - \theta_{p'ntz}) Q_{p'ntz}^a \quad \forall p \in P^{MP} \cup P^{PF}, \forall n \in R, \forall t \in T, \forall z \in Z \quad (4.38)$$

Inventory of output products (raw material, components) from recycling centers

$$I_{pn(t-1)}^{ro} + \sum_{z \in Z} Q_{pntz}^r = I_{pnt}^{ro} + \sum_{n' \in F} \sum_{m \in M} F_{pnn'mt} \quad \forall p \in P^{MP} \cup P^{PF}, \forall n \in R, \forall t \in T \quad (4.39)$$

Initial inventory level of output products (raw material and components) from recycling centers

$$I_{pn0}^{ro} = 0 \quad \forall p \in P^{MP} \cup P^{PF}, \forall n \in R \quad (4.40)$$

Inventory capacity of output products (raw material and components) at recycling centers

$$I_{pnt}^{ro} \leq i_{pnt}^{ro} \quad \forall p \in P^{MP} \cup P^{PF}, \forall n \in R, \forall t \in T \quad (4.41)$$

Recycling process capacity

$$\sum_{z \in Z} Q_{pntz}^a \leq q_{pnt}^r Y_{nt}^r \quad \forall p \in P^{PF}, \forall n \in R, \forall t \in T \quad (4.42)$$

If a node is operational, it is used for the planning horizon

$$Y_{nt}^r \geq Y_{n(t-1)}^r \quad \forall n \in D, \forall t \in T \quad (4.43)$$

Transportation

Transportation capacity

$$\sum_{p \in P^{MP} \cup P^{PF}} F_{pnn'mt} \leq c_{mnn't} Y_{mnn't}^l \quad \forall n \in N, \forall n' \in N, \forall m \in M, \forall t \in T \quad (4.44)$$

If the recycling center is not located in a specific region then it is not operational

$$Y_{nt}^R \leq \sum_{z \in Z} Y_{nz}^l \quad \forall n \in R, \forall t \in T \quad (4.45)$$

Limited number of distribution centers per zone

$$\sum_{z \in Z} Y_{nz}^l \leq 1 \quad \forall n \in D \quad (4.46)$$

Carbon management

At each period $\forall t \in T$ and zone $\forall z \in Z$, the company must be in compliance with the limitation of carbon emissions (CO₂e), thus

$$\begin{aligned}
& \sum_{o \in O} CO_o^{out} \left[\sum_{p \in P^{PF}} \sum_{h \in H} \sum_{n \in F} EF_{oph}^p Q_{phntz}^p + \sum_{p \in P^{PF}} \sum_{n \in R} EF_{opn}^r Q_{pntz}^r + \sum_{p \in P^{PF}} \sum_{n \in R} EF_{opn}^d Q_{pntz}^d \right] + \\
& \sum_{i \in I} CO_i^{in} \left[\sum_{p \in P^{PF}} \sum_{h \in H} \sum_{n \in F} CF_{iph}^p Q_{phntz}^p + \sum_{p \in P^{PF}} \sum_{n \in R} CF_{ipn}^r Q_{pntz}^r \right] + \sum_{p \in P^{PF}} \sum_{n \in R} CF_{ipn}^d Q_{pntz}^d \quad (4.47) \\
& CC_{tz}^+ - CC_{tz}^- \leq L_{tz}^{CO_2e} \quad \forall t \in T \forall z \in Z
\end{aligned}$$

Limit on the number of credits to purchase

$$CC_{tz}^- \leq L_{tz}^{COP} \quad \forall t \in T \forall z \in Z \quad (4.48)$$

Limit on the number of credits that can be sold

$$CC_{tz}^+ \leq L_{tz}^{COS} \quad \forall t \in T \forall z \in Z \quad (4.49)$$

4.6 Experimental evaluation

4.6.1 Data

The mathematical model has been developed, validated and was used in a preliminary study of a supply chain from the aluminum industry to illustrate the potential application as a decision making tool for sustainable supply chain planning under different environmental regulations that impose mandatory limits on carbon emissions as well as the obligation of product recovery and recycling at the end of life.

In this research, we consider the aluminum production as an example to study some important research questions and find some managerial decisions under environmental regulations. In the aluminum industry, there are typically two sources of raw materials, namely, bauxite which is the primary raw material from which aluminum is made, and secondary aluminum which is obtained by recycling aluminum products. Since aluminum is 100% recyclable without any loss of its natural qualities, recovery of the metal via recycling has become an important facet of the industry. Products under consideration can be made either made from primary or secondary aluminum using either one of two potential technologies which have different operating costs and different GHG emissions. Critical inputs and outputs including liquid, solid, energy, and gaseous wastes are considered.

We consider that the supply chain have two type of family products. Two production units are responsible for the production and products are distributed using two distribution centers. For each raw material, two suppliers are available. Used products are returned to recycling centers. Depending on the state of the returned product, they are recycled or disposed. The recycled products are returned to the production units to be used in the production process. An overview of the supply chain is shown in Figure 4.5. Some statistics for the model are summarized in Table 4.1.

Table 4.1
Statistics for the model

Model components	Quantity	Model components	Quantity
Periods	4	Production technologies	2
Materials	2	Distribution centers	2
Products	2	Clients	2
Regions	2	Recycling unit	2
Suppliers	2	Inputs	2
Production units	2	Outputs	2

It is clear from the model formulation in the previous section that some data to use in the model is sometimes difficult to find and the company should make an effort to collect a big number of input parameters to use the proposed model. However, the primary goal in this paper is to demonstrate how the mathematical model can be used in order to evaluate the impact of different legislations on the supply chain strategy and planning. In practice, the model could be modified to capture some specific strategic considerations of a given supply chain and populated with additional data.

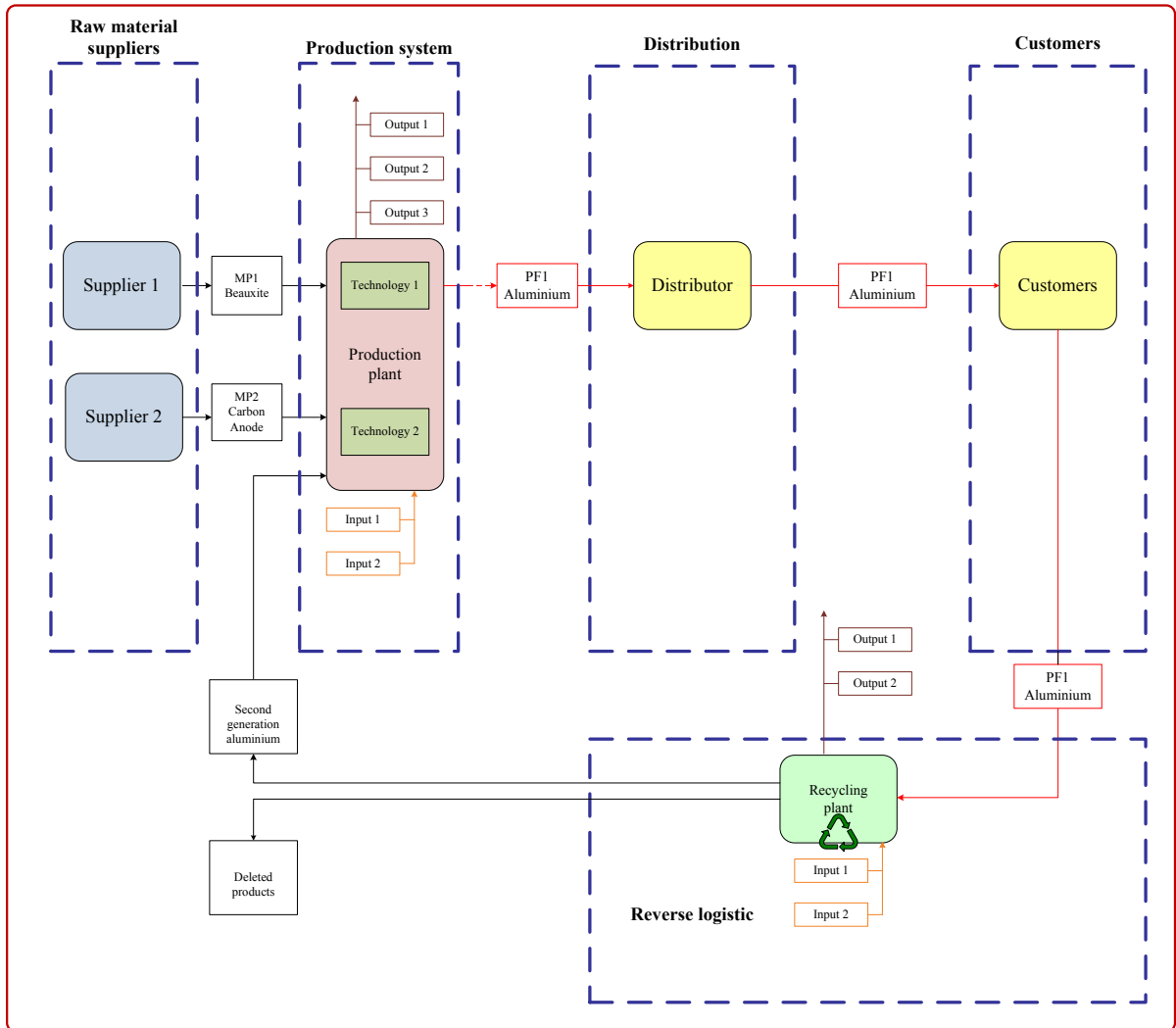

Figure 4.5 Case study supply chain network.

For the aim of the study, some parameters are estimated, the others ones are collected from the available information on the web. For example, the model developed in this paper highlights the importance of LCA data in order to help and inform managerial decision making. Numeric estimates of air emissions, solid waste generation, material consumption, are valuable in estimating model's parameters, thus enabling the bridging of operational and environmental decisions. The Intergovernmental Panel on Climate Change (IPCC), is an important source of data and was used to estimate emission factors (<http://www.ipcc-nggip.iges.or.jp/EFDB/main.php>).

4.6.2 Solution method

Different commercially-available optimization software exists today to solve MIP optimization problems. As discussed in previous section, it is currently impossible to use real data to populate the model. However, to demonstrate the practical solvability of the model, we randomly generate some numerical scenarios of parameters and constraints (see Table 4.2), and solve the model using the LINGO version of LINDO systems Inc on an AMD 2 493 Mhz PC running Windows XP.

Table 4.2
Characteristics of the MIP model

	Number of variables	Binary variables	Continuous variables	Number of constraints
Case study	1136	292	844	809

The mean and median run times per numerical scenario with the default LINGO solver settings, were 600 seconds and 500 seconds, respectively, which is a very practical amount of time. Although this example is with limited number of products and sites (suppliers, production units, and recycling centers), more sophisticated global optimization approaches for large scale optimization problem could be used to solve large scale supply chain network.

4.6.3 Research questions

In this section, we will present briefly the research questions that we attempt to answer by populating the model with data and solving it. To be in compliance with the environmental regulations, the company has different options. The first one is to re-locate production units and recycling centers at other regions. Carbon prices vary from one region to another. The company can invest on new production technologies to reduce carbon emissions and energy use. Thus the first research question is: Given the regulation on carbon emissions, what is the nature of compliance of the supply chain given the cost of the various compliance options

(the cost of green technologies versus carbon emission trading)? The second research question is: Given the regulation based on take back legislation that impose collection, recovery and recycling targets for products at the end of their life, what is the nature of managerial decisions related to the supply chain?

4.6.4 Results and discussion

The first aspect analyzed is the impact of carbon price variations on the supply chain configuration under two different scenarios. In scenario 1, carbon prices are stable in time. However, in scenario 2, carbon prices increase over time. The carbon prices (Figure 4.6) and results for scenario 2 are shown in Figure 4.7. Here, the carbon credit component is positive and represents 7% of the total cost. That means that the supply chain needs to buy \$1,441,320 worth of carbon credits during the planning period to be in compliance with the environmental regulation.

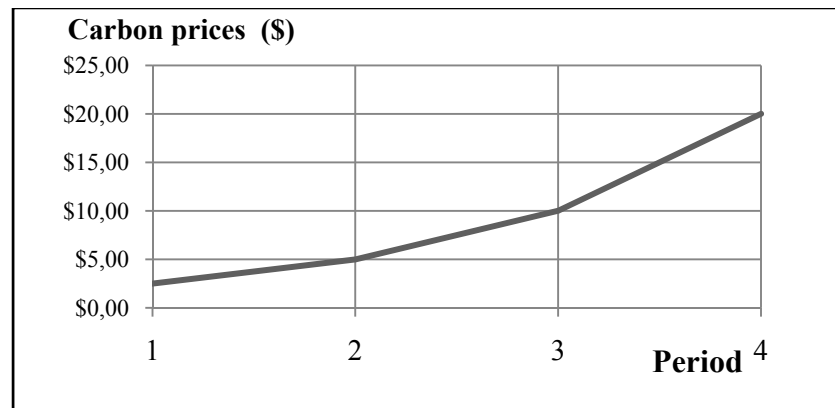

Figure 4.6 Carbon prices variation for scenario 2.

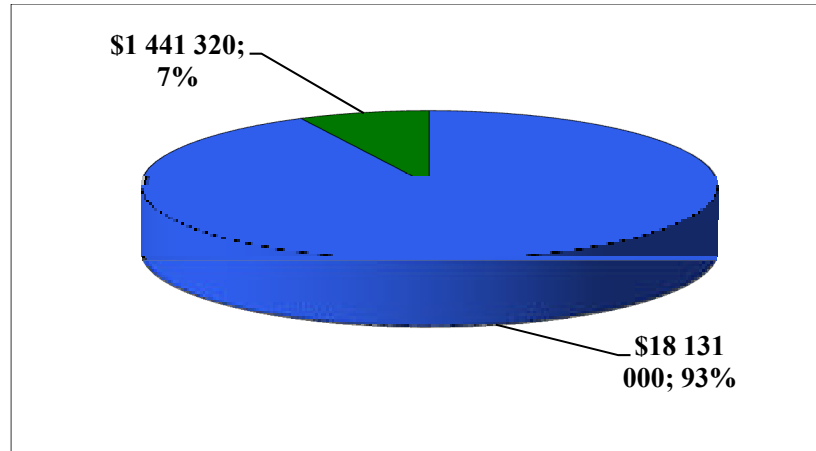

Figure 4.7 Cost distribution for scenario 2.

Table 4.3 compares the results obtained for the two scenarios. First, we observe that the emission cost for scenario 2 is higher but that the total logistic cost remains the same for both scenarios. This is because the supply chain configuration (combination of sites, technology used, distribution channels, etc.) is the same in both scenarios. Here carbon prices only resulted in an increase in total cost with no consequence on the supply chain configuration because the marginal cost for reducing one unit of GHG emissions is greater than the carbon price from the market. Hence, the best decision is to buy credits from the carbon market to be in compliance with the regulation limits on carbon emissions.

Table 4.3
Comparison of the two scenarios

	Scenario 1	Scenario 2
	Stable	Increase
Total Logistics Cost	\$18 131 000	\$18 131 000
Cost of Carbon credit	\$1 216 320	\$1 441 320
Total Cost	\$19 347 300	\$19 572 300

The second aspect analyzed is the impact of recycling strategies on supply chain planning decisions. Here we assume that legislation forces the company to accept all recycled products first. The supply chain is solved for different return rates (δ) of aluminum products. For the first scenario, we consider that only 80% of products available in the market are recycled ($\delta=80\%$). In the second scenario, secondary aluminum may come from other sources including the direct customers and hence a return rate of 120% ($\delta =120\%$). Table 4.4 summarizes the results obtained in this case. It shows that an increase in recycling of the products increases the total cost by 8.2% which translates into a 5.9% increase in logistics cost and a 41.1% increase in carbon credit cost. In this case, the legislation on recycling has a negative impact on carbon costs as it forces the supply chain to use technologies that have higher GHG emissions.

Table 4.4
Cost for the different scenarios (Return rate variation)

	Scenario 1 ($\delta = 80\%$)	Scenario 2 ($\delta = 120\%$)
Total Cost	\$19 347 300	\$20 929 800
Total Logistics Cost	\$18 131 000	\$19 214 100
Carbon credit	\$1 216 320	\$1 715 700

The final aspect studied is the impact of limit on emissions (LCO₂). We analyze two scenarios where regulations in terms of carbon emissions becomes more stringent (LCO₂ = 25 000 tCO₂e versus LCO₂ = 5 000 tCO₂e). In this case, we suppose that carbon prices will increase (Figure 4.6). Figure 4.8 shows that the quantity of recycled product increases as the limit of emissions is more stringent because carbon emissions are reduced due to the use of recycled product. When recycling is cheaper and with less GHG emissions, product recycling mostly increases and the cost is minimized.

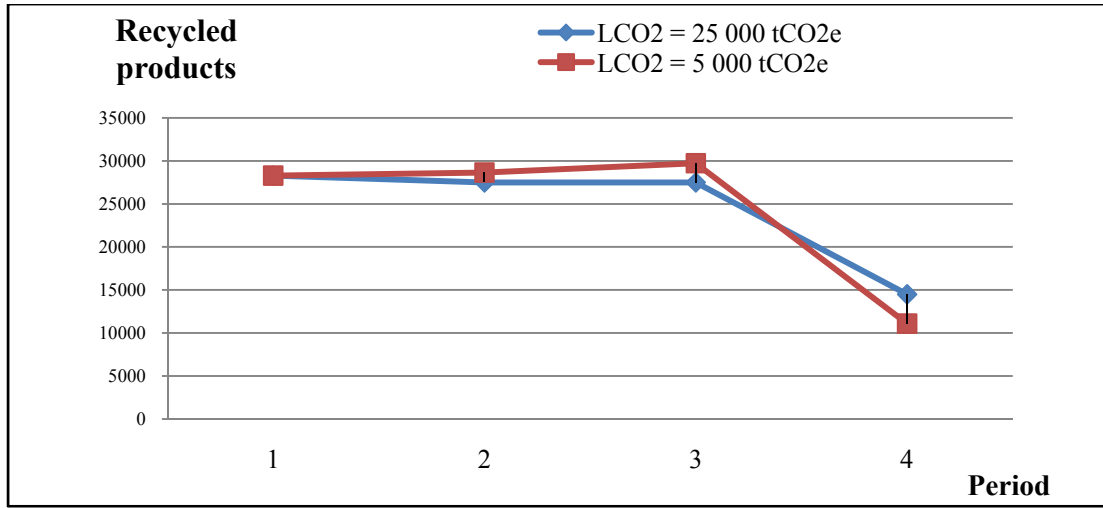

Figure 4.8 Recycled product under policy stringency.

However, in the last period, the quantity of recycled product decreases. Indeed, due to the strategy of carbon management (Figure 4.9) that consists of buying carbon credits when carbon prices are not expensive helps the company to reduce the cost of compliance to the regulation. Moreover, recycled products are less. This means that an environmental regulation that impose limits on GHG emission might lead to decrease recycling activities if recycling costs are not optimized.

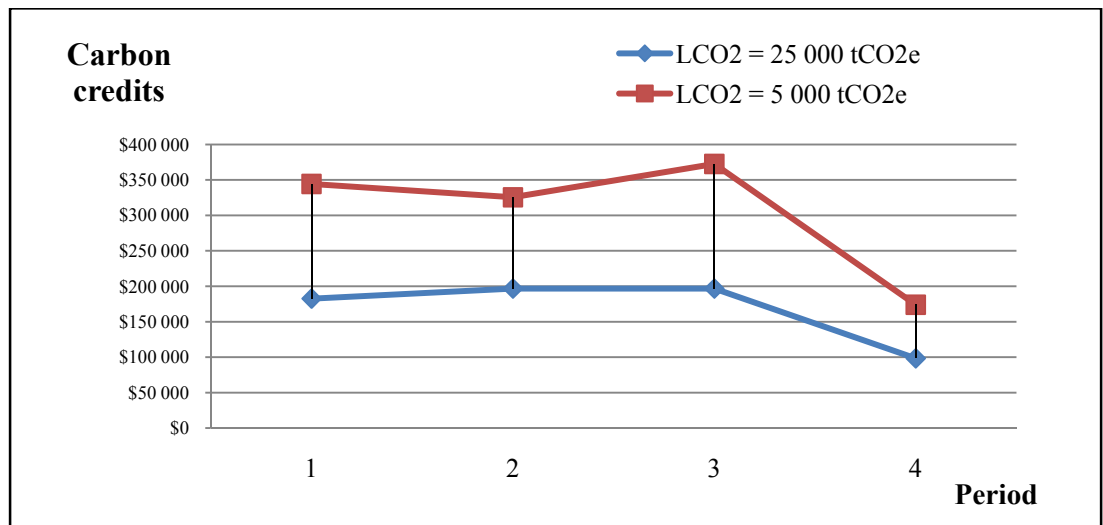

Figure 4.9 Carbon management under policy stringency.

4.7 Conclusion

In this article, we present a generic mathematical model to assist decision makers in designing sustainable supply chains over their entire life cycle. First, the model has the potential to be a tool that facilitates the understanding of optimal supply chain strategies under different environmental policies: recycling and GHG emissions reduction. The model shows that the various environmental legislations must be strengthened and harmonized at a global level in order to drive a meaningful long-term environmental strategy.

The explicit consideration of environmental costs within supply chain design is critical under the emergence of emission trading schemes. The integration of Life Cycle Analysis principles at the supply chain design phase maximizes the long-term sustainability. While some specific values of model's parameters would depend upon the application, the methodology presented here is general enough and may be applied to other supply chain studies to evaluate their performance in term of cost and carbon emissions.

Finally, although only the economic and environmental dimensions of sustainability are considered in the mathematical model, the methodology can integrate the social dimension as soon as measures of social sustainability are identified.

4.8 References

- Barker, T. J. and Zabinsky, Z. B. (2008) Reverse logistics network design : a conceptual framework for decision making. *International Journal of Sustainable Engineering*, 1, 250-260.
- Bayon, R., Hawn, A. and Hamilton, K. (2007) Voluntary carbon markets : an international business guide to what they are and how they work, London ; Sterling, Va., Earthscan.
- De Benedetto, L. and Klemes, J. (2009) The Environmental Performance Strategy Map : an integrated LCA approach to support the strategic decision-making process. *Journal of Cleaner Production*, 17, 900-906.

- Ferretti, I., Zanoni, S., Zavanella, L. and Diana, A. (2007) Greening the aluminium supply chain. *International Journal of Production Economics*, 108, 236-245.
- Frota Neto, J. Q., Bloemhof-Ruwaard, J. M., van Nunen, J. A. E. E. and van Heck, E. (2008) Designing and evaluating sustainable logistics networks. *International Journal of Production Economics*, 111, 195-208.
- Goetschalcks, M. and Fleischmann, B. (2008) Strategic Network Design. Supply Chain Management and Advanced Planning.
- Hugo, A. and Pistikopoulos, E. N. (2005) Environmentally conscious long-range planning and design of supply chain networks. *Journal of Cleaner Production : Recent advances in industrial process optimisation*, 13, 1471-1491.
- Jayaraman, V. (2006) Production planning for closed-loop supply chains with product recovery and reuse : An analytical approach. *International Journal of Production Research*, 44, 981-998.
- Jayaraman, V., Guide, V. D. R., Jr. and Srivastava, R. (1999) Closed-loop logistics model for remanufacturing. *Journal of the Operational Research Society*, 50, 497-508.
- Johnson, E. and Heinen, R. (2004) Carbon trading : time for industry involvement. *Environment International*, 30, 279-288.
- Labatt, S. and White, R. R. (2007) Carbon finance : the financial implications of climate change, Hoboken, N.J., John Wiley & Sons.
- Lieckens, K. and Vandaele, N. (2007) Reverse logistics network design with stochastic lead times. *Computers and Operations Research*, 34, 395-416.
- Luo, Y., Zhou, M. and Caudill, R. J. (2001) An integrated E-supply chain model for agile and environmentally conscious manufacturing. *IEEE/ASME Transactions on Mechatronics*, 6, 377-386.
- Nagurney, A., Liu, Z. and Woolley, T. (2006) Optimal endogenous carbon taxes for electric power supply chains with power plants. *Mathematical and Computer Modelling*, 44, 899-916.
- Peace, J. and Juliani, T. (2009) The coming carbon market and its impact on the American economy. *Policy and Society*, 27, 305-316.

- Pochampally, K. K., Nukala, S. and Gupta, S. M. (2009) Strategic planning models for reverse and closed-loop supply chains. Boca Raton, CRC Press.
- Ramudhin, A., Chaabane, A., Kharoune, M. and Paquet, M. (2008) Carbon Market Sensitive Green Supply Chain Network Design. IEEE International Conference on Industrial Engineering and Engineering Management, 2008. IEEM 2008.
- Ramudhin, A., Chaabane, A., Kharoune, M. and Paquet, M. (2010) Carbon market sensitive sustainable supply chain network design. *International Journal of Management Science and Engineering Management* 5 (1): 30-38.
- Rice, G., Clift, R. and Burns, R. (1997) Comparison of currently available european LCA software. *The International Journal of Life Cycle Assessment*, 2, 53-59.
- Sabri, E. H. and Beamon, B. M. (2000) A multi-objective approach to simultaneous strategic and operational planning in supply chain design. *Omega*, 28, 581-98.
- Seuring, S. and Muller, M. (2008) Core issues in sustainable supply chain management - a Delphi study. *Business Strategy and the Environment*, 17, 455-466.
- Sheu, J.-B. (2008) Green supply chain management, reverse logistics and nuclear power generation. *Transportation Research Part E : Logistics and Transportation Review*, 44, 19-46.
- Sheu, J.-B., Chou, Y.-H. and Hu, C.-C. (2005) An integrated logistics operational model for green-supply chain management. *Transportation Research Part E : Logistics and Transportation Review*, 41, 287-313.
- Srivastava, S. K. (2008) Network design for reverse logistics. *Omega*, 36, 535-548.
- Subramanian, R., Talbot, F. B. and Gupta, S. (2008) An Approach to Integrating Environmental Considerations within Managerial Decision-Making. SSRN eLibrary <http://ssrn.com/paper=1004339>.

CONCLUSION

The design of sustainable supply chains is very complex problem. The compliance with the different objectives of sustainable development requires a radical change in the paradigm of supply chain management that focuses not only on economic prosperity (minimize costs, or maximize profits), but also includes the environmental and social dimensions. Although strategic decision support systems and models for designing logistics networks are already difficult to treat, environmental regulations and corporate social responsibilities require that policymakers manage various compromises and identify the best decisions to achieve sustainability in an effective manner. This context leads researchers and practitioners to review these decision support models for the current design and reengineering of their supply chains.

This research has proposed new and more realistic approaches to design and evaluate sustainable supply chains with the establishment of an interaction with the fields of environmental management and carbon finance. It is clear that an integrated approach that considers a systemic view of the supply chain is more efficient for the decision making process. It allows the integration of the different interactions between system entities and as well as exchanges with the external environment which is often dynamic. This makes managing sustainable supply chain extremely complex and the use of a hierarchical planning approach seems to be more appropriate. At this level, strategic, tactical and operational activities are executed independently. For example, after obtaining the configuration of the supply chain, we can go in determining procurement, inventory, production, and distribution management policies. Although this approach requires several stages of validation, it is better than simultaneous planning approach that requires an amount of data often difficult to find and adds a level of complexity to develop a solution.

In the first paper (Chapter 1), we presented a multi-criteria approach with two-phases for managing supply chains. For the first stage, strategic decisions are treated and we decide on the supply chain configuration to choose according to the criteria defined in advance by decision makers. The analysis showed that depending on the company's corporate strategy, the network to consider could change. Using the AHP method, the decision maker could succeed in selecting the appropriate logistics network that supports strategic business objectives. In a second phase, we move to a tactical level. The choice was directed towards the identification of the inventory management policies, particularly the problem of safety stock positioning of in the logistics network, a problem raised by the company of Pratt & Whitney Canada. We proposed a mathematical model that takes into account demand variability as well as supply, production and transportation delay. The analysis showed that under demand uncertainty, the supply chain should invest in the establishment of safety stocks in strategic locations that will minimize inventory costs and guarantee the expected service level for customers. The environmental and social criteria are not included in the selection process, but could easily be introduced through the AHP analysis. In addition, at the first phase, it was assumed that some potential supply chain networks alternatives are available, however the question is: how to get these networks?

To generate potential networks to be analyzed by the AHP method, we have proposed in the second and the third articles (Step 1a of the proposed approach) different mathematical models for the design and evaluation of sustainable supply chains. In addition to the traditional economic function which is often considered in the design phase, the environmental function has been introduced in an optimization problem with multiple objectives. In order to guarantee a systemic approach for modelling the supply chain management process, we considered two types of mechanisms available to achieve sustainability objectives. The first category contains internal mechanisms including sourcing and sub-contracting options, technological choices, production strategies, storage options, transportation options, and reverse logistics activities. The second category includes the different incentives and legislations constraints available to achieve the goals of

sustainability such as the greenhouse gases emissions mechanisms (carbon market) and the take back legislation.

In the second article (CHAPTER 2), we were able to adequately model the design problem of supply chains that are subject to constraints and environmental laws that impose price on carbon emissions and where GHG emissions reduction is mandatory. We have shown that the interaction with the carbon market, supply chains can meet the environmental constraints more efficiently. The study shows that the proposed approach is very practical and provides a decision support tool for managers seeking to identify the best strategic decisions to be implemented to achieve sustainability objectives. The proposed model has some limitations because it is assumed that Carbon prices are unchanging in time and reverse logistics activities are not included.

To overcome the limitations of the second article, we have proposed in the third article (CHAPTER 4) a generic mathematical modeling framework for the sustainable supply chain network design problem. A multi-period multi-product mathematical programming model with multiple objectives has been introduced. To ensure a more realistic representation of the supply chain considered in this research, we applied the product life cycle assessment (LCA) concept to calculate the inventory in terms of GHG emissions and the use of critical resources for the company. To answer some research questions, realistic data and environmental regulatory constraints were used. The analysis presented in this work show that the model can be used as a decision tool to predict the impact of regulations that impose limits on GHG emissions as well as constraints for product recovery at the end-of-life.

In conclusion, the overall contribution lies in the explicit integration of environmental factors and more especially mechanisms available such as carbon market in the decision support tool for supply chain management. In addition, different approaches of operational research including multi-objective optimization methods (epsilon constraint, goal programming), multi-attribute analysis (analytic hierarchy process), and dynamic programming have been applied to provide a comprehensive design and evaluation of sustainable supply chains solutions.

Previous research did not give justice to such an analysis, especially to properly consider the interface between operations management and the environment. Regulations on emissions (liquids, solids, gases) are increasing. The results obtained show that there is compromise between economic and ecological criteria. But on the other hand, there are benefits at the social level that are sometimes difficult to quantify and that can afford sustainable development of the supply chain. This opens the debate about the integration of the social dimension in the decision making of supply chain design.

The theoretical framework introduced in this research for mathematical modeling and design problem of sustainable supply chains could be subject to several extensions. Indeed, it is clear that in order to achieve sustainability goals (economic, environmental, and social), data accuracy is paramount. In addition, the development of efficient solution approaches to solve large multi-objective optimization problems is necessary. Finally, and from an application perspective, it is important to explore several industrial sectors in order to be sure that the proposed theoretical framework provides valuable insights to supply chains subject to or anticipating environmental legislation.

APPENDIX I

TRADE-OFF MODEL FOR CARBON MARKET SENSITIVE SUSTAINABLE SUPPLY CHAIN NETWORK DESIGN

Amin Chaabane, Amar Ramudhin, Mourad Kharoune, Marc Paquet

Département de génie de la production automatisée, École de Technologie Supérieure,
1100 Notre-Dame Ouest, Montréal, Québec, Canada H3C 1K3

Cet article sera publié dans la revue International Journal of Operational Research,
Volume 10, Issue 4, 2011

Résumé

Cet article, inséré en annexe, s'intitule « *Trade-off model for carbon market sensitive sustainable supply chain network design* ». J'ai œuvré comme chercheur principal au développement des concepts, à l'écriture du modèle, à la réalisation des expérimentations et à la rédaction de l'article. Cet article a été accepté pour publication dans la revue International Journal of Operational Research (IJOR), chez l'éditeur Inderscience Enterprises. De plus, la version préliminaire courte de cet article a été présentée à Toronto (Canada) à dans le cadre de la conférence Sixth Annual International Symposium on Supply Chain Management (2008).

Abstract

Sustainable Supply Chain Network Design involves taking into account social, economic and environmental objectives at design time. While the social dimension is sometime harder to capture or quantify in mathematical terms, the Emission Trading Schema (ETS) introduces a natural trade-off between the economic and the environmental dimensions. This article

addresses the design of supply chains that are also sensitive to the carbon market. Carbon emissions and total logistics costs are integrated in the design of the supply chain using a multi-objective mixed-integer linear programming model that is solved by goal programming. The proposed methodology provides decision makers with the ability to evaluate the trade-offs between total logistics costs and carbon offsetting under different supply chain operating strategies, environmental regulatory constraints and carbon market evolution. The approach is presented through an illustrative example derived from the steel industry where new legislation imposes regulatory carbon caps on emissions. The results show that this approach is a good starting point for a more comprehensive framework for sustainable supply chain network design.

Introduction

Governmental regulatory frameworks to reduce greenhouse gases (GHG) emissions are currently being developed and/or implemented in many countries around the globe. As a consequence, companies are facing new realities, and need to consider the different existent options and mechanisms to meet their legal obligations under the proposed regulation. Ideally, firms will reduce their own emissions through green actions such as the implementation of energy efficiency measures, the deployment of carbon capture and storage systems, or investing in other emissions reduction technologies. Moreover, companies can have an access to other compliance mechanisms to earn carbon credits with the contribution to climate change technology fund or through an Emission Trading Scheme (ETS).

The ETS is based on a “cap-and-trade” approach where GHG emissions cap is enforced. Companies that reduce emissions below the cap would be allocated tradable credits. Those corporations that exceed their cap need to buy an equivalent amount of carbon credits to meet their regulatory obligation (Figure A I-1).

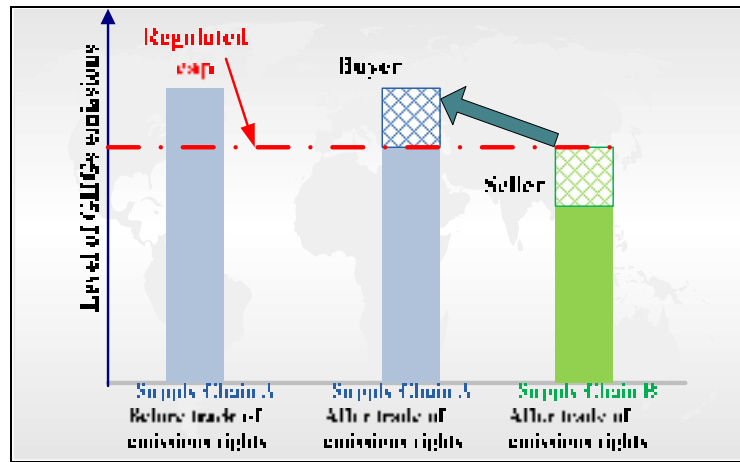

Figure A I-1 Overview of Emissions Trading.

There are a range of active programs to manage GHG emissions. These programs establish a market by setting a target (“absolute cap” or “intensity target”) and allow mandated participants to trade emissions credits in order to meet compliance requirements at the lowest possible cost. Emissions trading systems differ from each other in terms of the level of the cap or the level of intensity improvement mandated, the type of trading permitted, i.e. credits only or baseline-and-credit, their sector scope (e.g. power sector only as in New South Wales, large energy-intensive installations as in the European Union Emission Trading Scheme (EU ETS), or economy-wide as in the UK Emission Trading Scheme (UK ETS), and the extent of flexibility (e.g. geography, use of external offsets from developing countries and other industrialized nations, and ability to carry forward unused credits or offsets across compliance periods) (Karan and Philippe, 2008). Carbon emissions’ trading has been steadily increasing in recent years. According to the World Bank’s Carbon Finance Unit, 374 million

metric tons of carbon dioxide equivalent (tCO₂e) were exchanged through projects in 2005, a 240% increase relative to 2004 (110 m tCO₂e) which was itself a 41% increase relative to 2003 (78 mtCO₂e). In terms of dollars, the World Bank has estimated that the size of the carbon market as follows : 11 billion USD in 2005, 30 billion USD in 2006, and 64 billion in 2007² (Table 1).

The trading of emissions under a “cap-and-trade” system places supply chains managers in a different situation compared with the traditional control approach. First, corporations must consider the available options internally that might allow them to meet the cap. Second, they must compare the cost of implementing some of these options with the current trading price of emissions. The trading system pushes all participants to compete in order to meet the “reduction target” at the minimum cost. At this level, the theory of a “cap-and-trade” emissions reduction system is extremely simple : it is a choice between “make or buy”, either they make the reduction or they buy credits from someone who has done more than the required by the cap (Labatt and White, 2007).

In practice, the implementation of such an approach by supply chain managers is more complex because of the many options available at all stages of the supply chain : product design options, process options, transportation options, and reverse logistics options (recycle, reuse, etc.). Thus, the development of more accurate Decision Support Systems (DSS) to provide real assessment of green supply chain management practices and analysis of different

² <http://carbonfinance.org/>

strategic investment planning scenarios are necessary. A comprehensive framework that links internal strategic decision-making (i.e. supply chain network design) with the available external mechanisms (i.e. carbon market) is very useful to achieve efficiently the mandatory GHG reductions.

Table A I-1
State of the Carbon Market (Karan and Philippe, 2008)

	2006		2007	
	Volume (MtCO ₂ e)	Value (MUS\$)	Volume (MtCO ₂ e)	Value (MUS\$)
Allowances				
EU ETS	1,101	21,136	2,001	30,087
New South Wales	20	225	23	224
Chicago Climate Exchange	10	38	23	73
UK ETS	05	05		
Sub total	1,134	24,690	2,109	50,394
Project based transactions				
Primary CDM [*]	537	5,804	531	7,426
Secondary CDM	25	445	240	3,451
JT [†]	10	141	41	498
Other Compliance & Voluntary Transactions	39	105	42	265
Sub total	611	6,536	874	13,641
TOTAL	1,745	31,235	2,983	64,035

^{*} Clean Development Mechanism, [†] Joint Implementation

In this research, a mathematical model formulation and a solution procedure for the “Carbon-Market Sensitive Green Supply Chain Network Design” (CMS/GSCND) problem is developed. Specifically, carbon trading considerations are integrated within the supply chain network design phase and the problem formulated as a multi-objective mixed integer linear optimization program to decide on the supply chain configuration (Figure 2). The solution methodology allows the evaluation of different strategic decisions (options), such as suppliers’ and subcontractors’ selection, product allocation, capacity utilization, transportation configuration, and their impact in term of carbon footprint. This new formulation provides decision makers with the ability to understand the trade-offs between total logistics costs and the impact of GHG reductions. It also allows the offsetting of the

latter (“carbon zero”) through an interaction with the carbon trading market. Model validation and extended analysis are demonstrated via a numerical study.

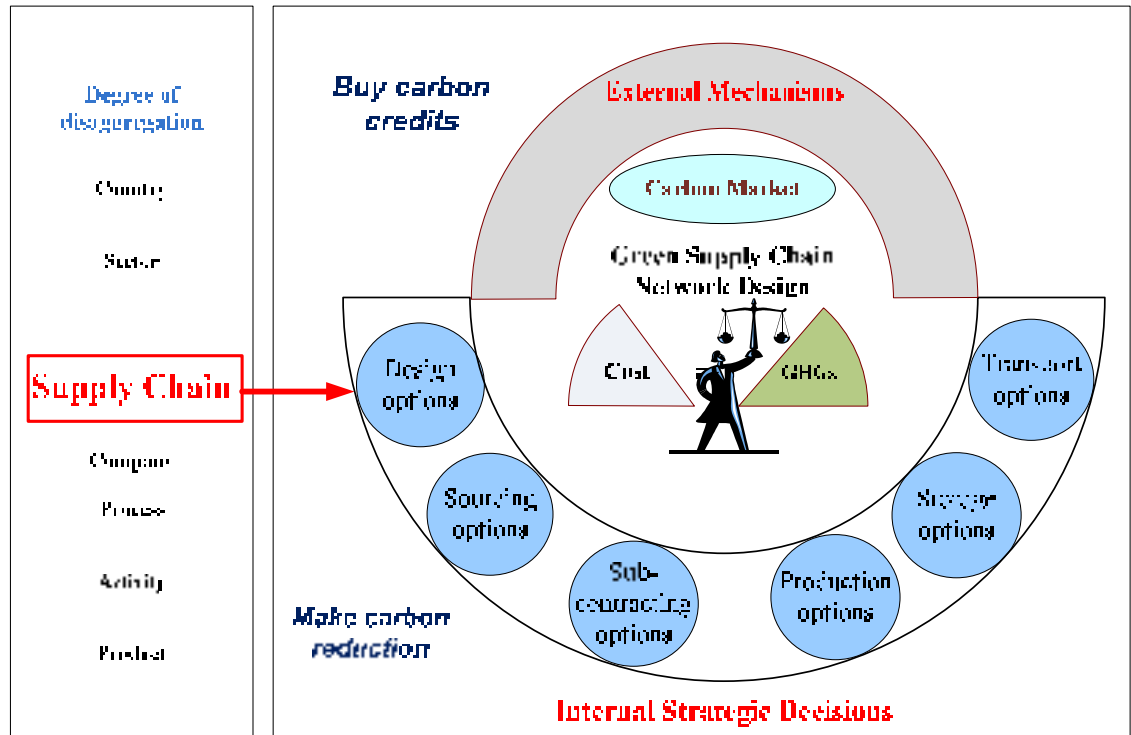

Figure A I-2 Research objectives.

Literature review

Traditional SCM practices identify certain performance measures which are the drivers in the evaluation of supply chain effectiveness and efficiency. Typically, they were concerned with : (1) customer satisfaction, service level, or responsiveness and (2) costs. GSCM is based on the recognition that the environmental dimension (GHG emissions and other natural resources) must be taken into account when managing supply chains (Srivastava, 2007). Best GSCM practices require that supply chain managers take different decisions (strategic, tactical, and operational) while considering the balance (trade-offs) between the different main performances : cost, service level, and carbon emissions. Unfortunately, these performances are usually conflicting and need advanced optimization techniques to find the best trade-offs. Multi-Objective Optimization (MOO), a well established area within the field

of operational research and being able to consider conflicting objectives (Cohon, 1978), enables modeling of many problems in business, engineering, operations management and more specifically in supply chain management (SCM) problems.

Multi-Objective Optimization methods for SCM

MOO modeling techniques have been used in different studies. Very early, Arntzen et al. (1995) introduce a global supply chain model to manage complexity in an international context. The “weighted sum method” was used to minimize cost or weighted cumulative production and distribution times or both subject to a set of technological constraints. Li and O’Brien (1996) focused on improving supply chain efficiency and effectiveness under four criteria : profit, lead-time, delivery promptness, and waste elimination. Sabri and Beamon (2000) develop an integrated multi-objective supply chain model for simultaneous strategic and operational planning in supply chain design. The “ ϵ -constraint” method is used to minimize cost, while ensuring a sufficient amount of volume flexibility and service level (fill rate). Nozick and Turnquist (2001) address the question of locating distribution centers. They show that the optimization of these location decisions requires careful attention to the trade-offs among facility costs, inventory costs, transportation costs, and customer responsiveness. Chen et al. (2003, 2004) propose a fuzzy decision-making method to achieve a compromise solution among all participant companies of the supply chain. Guillen et al. (2005a, 2005b) study the problem of design and retrofit of a supply chain (SC) consisting of several production plants, warehouses and markets, and the associated distribution systems. The approach enables management of financial risk associated to the different design options, resulting in a set of Pareto optimal solutions that can be used for making decisions. They use the “ ϵ -constraint” method with a branch and bound technique to solve a multi-objective stochastic mixed integer linear programming model. Shen and Daskin (2005) develop a nonlinear model that determines distribution center locations and the assignment of demand nodes to distribution centers in order to optimize the cost and service objectives. They use a “weighting method” to find all supported points on the trade-off curve. The results suggest that significant service improvements can be achieved relative to the minimum cost solution at a relatively small incremental cost. Altıparmak et al. (2006) propose a solution procedure

based on genetic algorithm to find the set of Pareto-optimal solutions for multi-objective supply chain network design problem. Finally, Pokharel (2008) develops a two-objective decision-making model for the choice of suppliers and warehouses for a supply chain network design problem. They demonstrate that these decisions differ when two objectives, the cost and delivery lead times, are considered simultaneously.

Later, in response to more rigid environmental regulations and in order to establish sustainable supply chain, it was necessary to include the impact of supply chain operations on the environment. There is an extensive literature about different aspects of GSCM (Seuring and Muller, 2008; Srivastava, 2007) : green design (Hugo and Pistikopoulos, 2005), inventory management, production planning and control for remanufacturing (Lu et al., 2007), green manufacturing, product recovery (Jayaraman et al., 1999), reverse logistics (Sheu et al., 2005), waste management (Ferretti et al., 2007), energy use (Dotoli et al., 2006), and GHG emissions reduction (Ferretti et al., 2007). It is not surprising to see that mathematical modeling based methodologies are the most common approaches used to tackle GSCM problems. Indeed, these models can be embedded as decision support systems (DSS) for GSCM. DSS proved their efficiency to manage traditional supply chain networks known today as advanced planning and scheduling systems (APS). Moreover, MOO optimization modelling approaches have been used to tackle GSCM problems.

Giannikos (1998) presented a multi-objective linear model for locating disposal or treatment facilities and transporting hazardous waste along the links of a transportation network. Min and Melachrinoudis (1999) present a real world case study involving the re-location of manufacturing and distribution facilities based on different criteria including the environmental dimension (climate). Analytic Hierarchy Process (AHP) was used to aid management in formulating a more efficient and effective relocation strategy. Luo et al. (2001) present a mathematical model to design and optimize supply chains in the context of global and Internet- manufacturing based on different performances such as cost, cycle time, quality, energy use and environmental impact. A multi-objective optimization model is formulated and solved for a personal computer (PC) company. Hugo and Pistikopoulos (2005) presented a mathematical programming-based methodology for the explicit inclusion

of life cycle assessment (LCA) criteria as part of the design and planning of supply chain networks. A decision-support tool for environmentally conscious strategic planning is introduced.

Sheu et al. (2005) present a linear multi-objective programming model to optimize the operations of both integrated logistics and corresponding used-product reverse logistics. Factors such as the used-product return ratio and corresponding subsidies from governmental organizations for reverse logistics are considered. Dotoli et al. (2005, 2006) propose a multi-level approach for network design of supply chains. They introduce a good framework to study integrated decision-making of environmental conscious supply chains. The multi-objective integer linear programming solution provides different network structures that allow improving supply chain flexibility, agility, and environmental performance (carbon dioxide emissions) in the design process. Lu et al. (2007) present a method using simple and efficient procedures to evaluate the effectiveness of projects supplying green supply chain concept. Specifically, a multi-objective decision making process for green supply chain management is presented to help the supply chain manager in measuring and evaluating suppliers' performance based on AHP method. Ferretti et al. (2007) propose a model to evaluate the economic and environmental effects of the industrial practice case study. The result is the determination of the supply aluminum mix, i.e. molten and solid alloy, capable of balancing the economic benefits (highest scrap values, lowest total costs) as well as environmental requirements. Finally, Frota Neto (2008) developed a multi-objective program for designing and evaluating sustainable logistics network where both cost and the environmental impact are considered. The approach was applied to European pulp and paper industry.

Literature summary and critics

Appendix A summarizes the existing literature based on two performances categories : traditional supply chain performances and green supply chain performances. Also, for each model, we specify the solution technique used to deal with multiple objectives performance functions. In general, MOO can be handled in four (4) different ways depending on when the

decision-maker articulates his preference on the different objectives, never (Method 1), before (Method 2), during (Method 3) and after (Method 4) the optimization procedure. In the first two approaches, the objectives are aggregated to one overall objective function. Optimization is then conducted with one optimal result. The third approach is an iterative process where the decision maker progressively articulates his preference on the different objectives. In the fourth approach, optimization is conducted without articulating any preferences. The outcome of this optimization is a set of Pareto optimal solutions which elucidate the trade-offs between the objectives.

In addition, it can be concluded from the literature that SCM have been evolved to integrate the environmental dimension in order to create green supply chains. Nevertheless, there is a gap in the development of integrated framework for GSCM :

- Literature stresses more on reverse logistics activities. Indeed, an integrated approach that considers the different available options internally is absent.
- The linkage with external mechanisms (e.g. emissions trading) to respect mandatory target in terms of environmental objectives is completely absent. Indeed, an integrated approach for GSCM must consider the most cost-effective solution while respecting the mandatory regulation and takes the advantages of the different available mechanisms.
- Due to GHG emissions trading, companies should expect to pay for their emissions and must put a price tag for GHG emissions, something that has been completely ignored by the literature.
- MOO presents many advantages to design green supply chains and consider the trade-offs between different objectives in the decision making process. However, some computational difficulties could be expected.

Trade-off model for CMS/GSCND

Model overview

The model introduced in this section focuses on studying the impact of transportation and production activities within a CMS/GSCND strategy. The supply chain structure considered is presented in Figure 3. The model evaluates the total quantity of supply chain GHG emissions, in term of tCO₂e, and determines the resulting carbon credits generated for different configurations of the supply chain. Indeed, companies below their cap (i.e. their GHG emissions are less than a certain quota fixed by government regulations) would earn credits, while those exceeding their cap (GHG emissions are greater than quotas) would need to purchase credits to make up the shortfall. The 4-steps methodology is generic enough to be applied to any manufacturing context :

- Step 1 : Assessment of total logistics costs and GHG emissions for the actual supply chain that serves as a base line for future improvement.
- Step 2 : Optimize the supply chain with the proposed model. Different analysis can be performed in order to study different strategies that are in line with the corporate sustainability objectives.
- Step 3 : Decide on the strategy to implement, make GHG reduction or buy credits.
- Step 4 : Evaluate and monitor the new supply chain for continuous improvement.
- Fundamental to the model is the use of mixed integer linear programming (MILP) technique to capture the interaction between the supply chain structure and its environmental impact.

Modeling approach

The supply chain considered in this study is composed of different potential suppliers, sub-contractors and plants that serve customers in different regions. Different technologies can be acquired to manufacture products. Also, different transportation modes can be used for products delivery between nodes (suppliers, sub-contractors, plants, and customers).

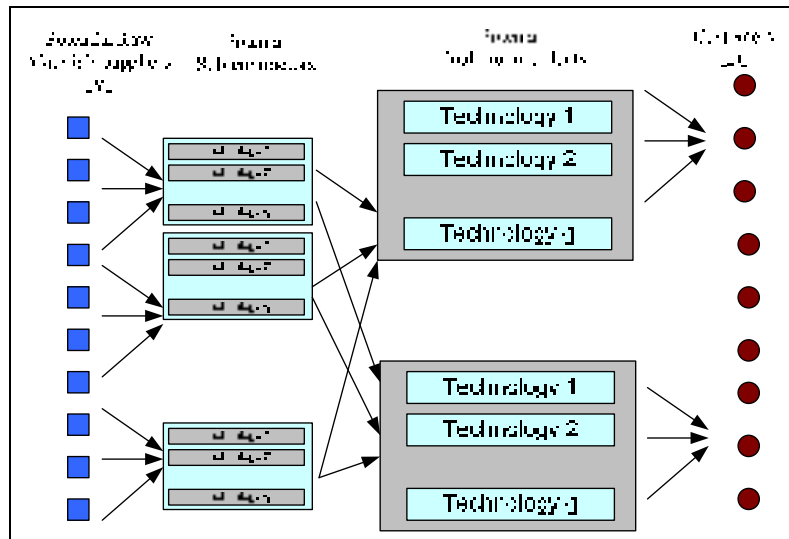

Figure A I-3 Supply chain structure.

The Bill of Material (BOM) for a specific product is presented in Figure 4. Three categories of products are considered : raw materials manufactured products, and finished products.

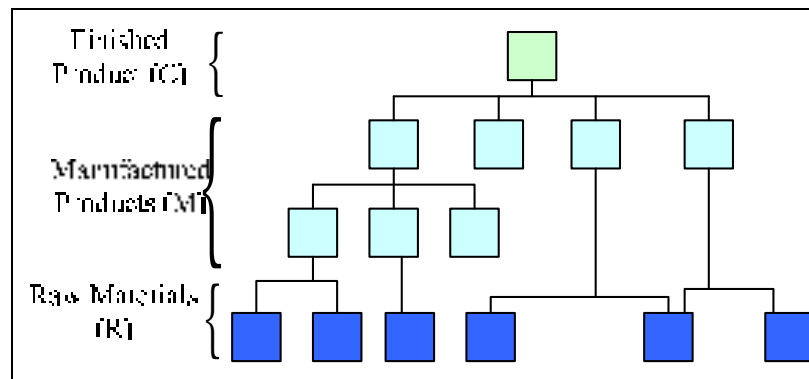

Figure A I-4 Bill Of Material (BOM).

Sets and indices

In this study, the following sets and indices are used :

P	Set of all products
$R \subset P$	Set of raw materials
$M \subset P$	Set of manufactured products
$C \subset M$	Set of finished products
N	Set of all nodes
G	Set of manufacturing technologies
$D \subset N$	Set of customer zones
$S \subset N$	Set of all subcontractors
$S_p \subset S$	Set of subcontractors of product $p \in M$
$V \subset N$	Set of suppliers of raw materials
$V_p \subset V$	Set of suppliers of raw material $p \in R$
P_p^s	Set of immediate successors of product $p \in P/C$ in the BOM
SP_p^s	Set of subcontractors for the set of immediate successors of product $p \in P/C$
M_i	Set of products that can be manufactured by subcontractor $i \in S$
R_i	Set of raw materials that can be supplied by supplier $i \in V$
K	Set of all transportation modes $k \in K$

Parameters

The strategic mathematical model requires the following cost parameters :

λ_i	Fixed cost associated with the use of site $i \in S \cup V$
-------------	---

κ_i^g	Fixed cost associated with the acquisition of technology $g \in G$ at site $i \in S$
a_{ip}	The start-up cost associated with manufacturing product $p \in M$ to site $i \in S_p$
b_{ip}	Purchasing unit cost of raw material $p \in R$ at site $i \in V_p$
c_{ip}^g	Unit cost of producing product $p \in M$ at site $i \in S_p$ using technology $g \in G$
t_{ijp}^k	transportation unit cost of product $p \in P$ from node $i \in V_p \cup S_p$ to node $j \in SP_p^s \cup D$ using transportation mode $k \in K$
l_{ij}^k	Cost of a single shipment between nodes $i \in V \cup S$ and $j \in S \cup D$ using transportation mode $k \in K$
ϕ	Price per metric ton of carbon dioxide equivalent (tCO ₂ e)

The following data are also needed :

α^k	Greenhouse gases emissions factor per weight unit and per distance unit due to the use of transportation mode $k \in K$ per ton-mile
β_{ip}^g	Greenhouse gases emission factor (tones) per weight of produced quantity of product $p \in M$ using the technology $g \in G$ at node $i \in S_p$
$L_{Emission}$	Limit of emission fixed by government regulation
$\theta_{pp'}$	Number of products $p \in P/C$ required to manufacture one unit of product $p' \in P_p^s$
m_p	Maximum number of sites that can be opened for product $p \in M \cup R$
e_{ip}	Capacity of node $i \in S_p$ for product $p \in R$ (supplier's capacity)
f_i^g	Available time of at node $i \in S$ when using technology $g \in G$
te_{ip}^g	Processing time on product $p \in M$ at node $i \in S_p$ using technology $g \in G$
d_{pd}	Number of product $p \in C$ required by demand node $d \in D$

ρ_i	Lower bound (in %) on the aggregated capacity to be used if manufacturer or supplier $i \in S \cup V$ is chosen
T_i	Total time available at the assembly line of subcontractor $i \in S$
τ_{ij}	Maximum number of transportation modes that can be used between nodes $i \in V \cup S$ and $j \in S \cup D$
κ^k	Volume capacity of transportation mode $k \in K$
ψ^k	Weight capacity of transportation mode $k \in K$
π_p	Weight of product $p \in P$
δ_p	Volume of product $p \in P$
$d(i, j)$	Distance between nodes $i \in V \cup S$ and $j \in S \cup D$

Decision variables

To find the optimal configuration of the network, the following decision variables are required :

A_i	Binary variable equals 1 if node $i \in V \cup S$ is open and operational for at least one product and 0 otherwise
W_i^g	Binary variable equals 1 if technology $g \in G$ is selected at node $i \in S$
Y_{ip}	Binary variable equals 1 if raw material $p \in R \cup M$ is assigned to node $i \in V_p \cup S_p$ and 0 otherwise
X_{ip}	Number of units of product $p \in R$ supplied by node $i \in V_p$
Q_{ip}^g	Number of units of product $p \in M$ manufactured by node $i \in S_p$ using technology $g \in G$

F_{ijp}^k Number of units of product $p \in P$ shipped from node $i \in V_p \cup S_p$ to node $j \in SP_p \cup D$ using transportation mode $k \in K$

U_{ij}^k Number of shipments between nodes $i \in V \cup S$ and $j \in S \cup D$ using transportation mode $k \in K$

Z_{ij}^k Binary variable equals 1 if transportation mode $k \in K$ is used between nodes $i \in V \cup S$ and $j \in S \cup D$ and 0 otherwise

Optimization model formulation

Logistics cost objective function

The total logistics cost (F_1) of the supply chain includes fixed and variable costs.

Fixed costs are :

- fixed costs for selecting the facilities (1);
- fixed cost for assignment products to sites (2);
- fixed cost for technology acquisition (3);
- fixed cost for transportation lanes (4).

Variable costs are of three types :

- Raw materials cost (5);
- Manufacturing cost (6);
- Transportation cost (8).

Greenhouse gas emissions cost / profit (8) : The GHG emissions cost/profit is calculated based on the credits compared to the limit of emissions ($L_{Emission}$) fixed by regulations. The expenses are outlined in Table 1.

Table A I-2
Cost structure of the objective function

Cost structure	Mathematical formulation
Fixed cost for facilities	$\sum_{i \in V \cup S} \lambda_i A_i$
Fixed cost for assignment products to sites	$\sum_{p \in R \cup M} \sum_{i \in V_p \cup S_p} a_{ip} Y_{ip}$
Fixed cost for technology acquisition	$\sum_{i \in S} \sum_{g \in G} \kappa_i^g W_i^g$
Fixed cost for transportation lanes	$\sum_{i \in S \cup V} \sum_{j \in S \cup D} \sum_{k \in K} l_{ij}^k U_{ij}^k$
Raw materials cost	$\sum_{p \in R} \sum_{i \in V_p} b_{ip} X_{ip}$
Manufacturing cost	$\sum_{p \in R} \sum_{i \in S_p} \sum_{g \in G_p} c_{ip}^g Q_{ip}^g$
Transportation cost	$\sum_{p \in M \cup R} \sum_{i \in S_p \cup V_p} \sum_{j \in S_p^s \cup D} \sum_{k \in K} t_{ijp}^k F_{ijp}^k$
GHG Emissions cost / profit	$\phi \left(\underbrace{\sum_{p \in M \cup R} \sum_{i \in S_p \cup V_p} \sum_{j \in S_p^s \cup D} \sum_{k \in K} \alpha^k \pi_p d(i, j) F_{ijp}^k}_{\text{GHGs Emissions from transportation}} + \underbrace{\sum_{p \in M} \sum_{i \in S_p} \sum_{g \in G_p} \beta_{ip}^g \pi_p Q_{ip}^g}_{\text{GHGs Emissions from process}} - \underbrace{L}_{\text{Emission Cap}} \right)$

Therefore, the objective function \mathbf{F}_1 that represents the total operational cost of the supply chain to be minimized is :

$$\text{Min } \mathbf{F}_1 = 1) + 2) + 3) + 4) + 5) + 6) + 7) + 8) \quad (\text{A-1})$$

Model constraints

For the MILP supply chain network design model, there are many constraints to be considered. These constraints are of many kinds including the balance constraints of all products, the capacity limit constraints, the minimum capacity occupation constraints, and

the demand satisfaction constraint. The BOM constraints are implicitly taken into account in the balance constraints. These elements are discussed below.

For each raw material and for each manufactured product, the number of operational sites should not exceed the maximum number allowed of suppliers and subcontractors :

$$\sum_{i \in S_p \cup V_p} Y_{ip} \leq m_p \quad (\forall p \in R \cup M) \quad (\text{A-2})$$

If a product (raw material) is assigned to a node (supplier), then the number of products supplied by this supplier must not exceed its capacity for this product :

$$X_{ip} - e_{ip} Y_{ip} \leq 0 \quad (\forall p \in R, \forall i \in V_p) \quad (\text{A-3})$$

A product (semi-finished or final product) is manufactured in a node (subcontractor) only if the product is assigned to this node :

$$\sum_{g \in G} Q_{ip}^g - M Y_{ip} \leq 0 \quad (\forall p \in M, \forall i \in S_p) \quad (\text{A-4})$$

Then the overall processing time used must not exceed the total available time at its assembly line or manufacturing facility :

$$\sum_{p \in M_i} t e_{ip}^g Q_{ip}^g - f_i^g W_i^g \leq 0 \quad (\forall i \in S, \forall g \in G) \quad (\text{A-5})$$

There is usually a minimum amount of the aggregate capacity of a subcontractor that should be consumed to justify the establishment of a contract. This consideration leads to constraints (6) where the first term is the total time used at the assembly line or manufacturing facility of subcontractor i in order to manufacture all the products. The second term of the left hand side of the inequality is the minimum time to be used if subcontractor i is chosen :

$$\sum_{p \in M_i} \sum_{g \in G_p} t e_{ip}^g Q_{ip}^g - \rho_i \sum_{g \in G} f_i^g W_i^g \geq 0, \forall i \in S \quad (\text{A-6})$$

To make a deal with a supplier, the minimum capacity can also be considered. Here, the minimum capacity to be used is a percentage of the total weight of all maximum quantities of raw materials that can be supplied by the supplier :

$$\sum_{p \in R_i} X_{ip} - \left(\rho_i \sum_{p \in R_i} b_{ip} \right) A_i \geq 0 \quad (\forall i \in V) \quad (\text{A-7})$$

The constraints of flow out of suppliers' nodes are given by the equalities below :

$$X_{ip} - \sum_{j \in SP_p^s \cup D} \sum_{k \in K} F_{ijp}^k = 0 \quad (\forall p \in P, \forall i \in V_p) \quad (\text{A-8})$$

The constraints of flow out of subcontractors' nodes are given by the equalities below :

$$\sum_{g \in G_p} Q_{ip}^g - \sum_{j \in SP_p^s \cup D} \sum_{k \in K} F_{ijp}^k = 0 \quad (\forall p \in P, \forall i \in S_p) \quad (\text{A-9})$$

For each product, the quantity that arrives to a node must equal the quantity needed to manufacture next higher assemblies :

$$\sum_{j \in S_p} \sum_{k \in K} F_{jip}^k - \sum_{p' \in P_p^s} \sum_{g \in G_p} \theta_{pp'} Q_{ip'}^g = 0 \quad (\forall p \in M, \forall i \in SP_p^s) \quad (\text{A-10})$$

The quantity of finished products shipped from all its subcontractors to the demand node must equal the demand of that product :

$$\sum_{i \in S_p} \sum_{k \in K} F_{idp}^k = d_{pd} \quad (\forall p \in C, \forall d \in D) \quad (\text{A-11})$$

For each couple of nodes, there is a maximum number of transportation modes that can be used.

$$\sum_{k \in K} Z_{ij}^k \leq \tau_{ij} \quad (\forall i \in V \cup S, \forall j \in S \cup D) \quad (\text{A-12})$$

The quantity of products shipped between two nodes is limited by the capacity of transportation mode and the number of shipments. While the first set of constraints (A-13) expresses the volume capacity and the second set (A-14) expresses the weight capacity :

$$\sum_{p \in R_i \cup M_i} \delta_p F_{ijp}^k - \kappa^k U_{ij}^k \leq 0 \quad (\forall i \in V \cup S, \forall j \in S \cup D, \forall k \in K) \quad (\text{A-13})$$

$$\sum_{p \in R_i \cup M_i} \pi_p F_{ijp}^k - \psi^k U_{ij}^k \leq 0 \quad (\forall i \in V \cup S, \forall j \in S \cup D, \forall k \in K) \quad (\text{A-14})$$

The following are logical constraints.

The number of shipments between two nodes for a given transportation mode is not nil only if the transportation mode is actually used. This yields to the following constraints :

$$U_{ij}^k - MZ_{ij}^k \leq 0 \quad (\forall i \in V \cup S, \forall j \in S \cup D, \forall k \in K), \text{ M is a big number} \quad (\text{A-15})$$

A site is selected if it is open for one product at least :

$$Y_{ip} - A_i \leq 0 \quad (\forall i \in S \cup V, \forall p \in M_i \cup R_i) \quad (\text{A-16})$$

The following are constraints on decision variables.

The transport variables, the quantities supplied and manufactured by sites are non negative :

$$F_{ip}^k \geq 0 \quad (\forall p \in R \cup M, \forall i \in V_p \cup S_p, \forall j \in SP_p^s \cup D, \forall k \in K) \quad (\text{A-17})$$

$$X_{ip} \geq 0 \quad (\forall (p, i) \in R \times V_p \cup M \times S_p) \quad (\text{A-18})$$

$$Q_{ip}^g \geq 0 \quad (\forall p \in M \forall i \in S_p \forall g \in G) \quad (\text{A-19})$$

Binary variables :

$$Y_{ip} \in \{0, 1\}, \forall (p, i) \in R \times V_p \cup M \times S_p \quad (\text{A-20})$$

$$A_i \in \{0, 1\}, \forall i \in S \cup V \quad (\text{A-21})$$

$$Y_{ip} \in \{0, 1\}, \forall p \in R \cup M \forall i \in S \cup V \quad (\text{A-22})$$

$$W_i^g \in \{0, 1\}, \forall i \in S \forall g \in G \quad (\text{A-23})$$

$$Z_{ij}^k \in \{0, 1\} \quad (\forall i \in V \cup S, \forall j \in S \cup D, \forall k \in K) \quad (\text{A-24})$$

The number of shipments must be integer :

$$U_{ij}^k \text{ integer} \quad (\forall p \in P, \forall i \in V_p \cup S_p, \forall j \in SP_p^s \cup D, \forall k \in K) \quad (\text{A-25})$$

An alternative objective function (F2) that can be considered is to minimize the total emissions quantity of GHG (tCO₂e) in order to evaluate the best potential reduction in term of GHG emissions. A solution obtained with function F2 will have a higher total logistics cost than if the cost is minimized (function F1).

$$\text{Min } \mathbf{F}_2 = \underbrace{\sum_{p \in M \cup R} \sum_{i \in S_p \cup V_p} \sum_{j \in SP_p^s \cup D} \sum_{k \in K} \alpha^k \pi_p d(i, j) F_{ijp}^k}_{\text{GHGs Emissions from transportation}} + \underbrace{\sum_{p \in M} \sum_{i \in S_p} \sum_{g \in G_p} \beta_{ip}^g \pi_p Q_{ip}^g}_{\text{GHGs Emissions from process}} \quad (\text{A-26})$$

In the case of minimizing F2, the following constraints should be added to the model.

No assignment of raw material to supplier if the raw material is not supplied by this supplier :

$$Y_p - X_{ip} \leq 0 \quad (\forall p \in P, \forall i \in V_p) \quad (\text{A-27})$$

No assignment of manufactured product to plants if the product is not manufactured in this plant

$$Y_p - \sum_{g \in G} Q_{ip}^g \leq 0 \quad (\forall p \in P, \forall i \in V_p) \quad (\text{A-28})$$

A technology is acquired only if it used to produce at least one product :

$$W_i^g - \sum_{p \in M_i} Q_{ip}^g \leq 0 \quad (\forall i \in S, \forall g \in G) \quad (\text{A-29})$$

A site is selected if it is open for one product at least :

$$A_i - \sum_{p \in M_i \cup R_i} Y_{ip} \leq 0 \quad (\forall i \in S \cup V) \quad (\text{A-30})$$

Illustrative example

We consider the case of a steel product manufacturer with high level of GHG emissions to illustrate the model. Three freight transportation modes are considered : rail, air, and road. The product has a multi-level BOM with two semi finished products that are manufactured from four parts sourced from various external suppliers. At least two suppliers are competing to supply each part. In this example, GHG emissions are limited to CO₂ caused by production and transportation activities. Emissions factors for the three freight transportation modes considered in this example and detailed in Table 2. The Emissions factors (α^k) considered in this example are based on the recent study published by Facanha and Horvath (2007).

Table A I-3
Freight transportation emissions factors (grams/ton-mile)

Transportation mode	Type	Payload (tons)	CO ₂ (grams/ton-mile)
Road	Class 8b	12.5	187
Rail	Intermodal rail	2,093	40
Air	Boeing 747-400	70	1,385

For the production activities, we consider that the manufactured products are composed basically of steel materials. The emission factor (β_{ip}^g) is given by the IPCC Emission Factor Data Base.

Experimentation

The model is first solved by CPLEX Interactive Optimizer 10.0 considering only objective function F1. The optimal cost is 2 696 051 \$. The total emission quantity relative to this solution is 21 067 tCO₂e. In addition, the model is solved while considering only objective function F2. The optimal GHG emissions quantity is 19 988 tCO₂e. The total cost relative to this solution is 2 864 915 \$. The cost breakdown for each scenario is illustrated in figures 5 and 6.

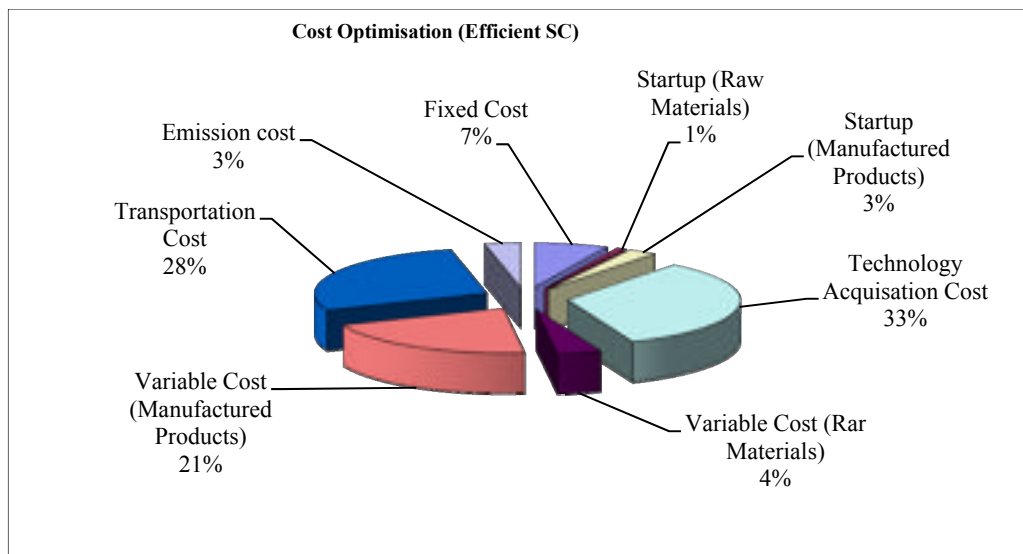

Figure A I-5 Cost breakdown for the optimal solution to F₁.

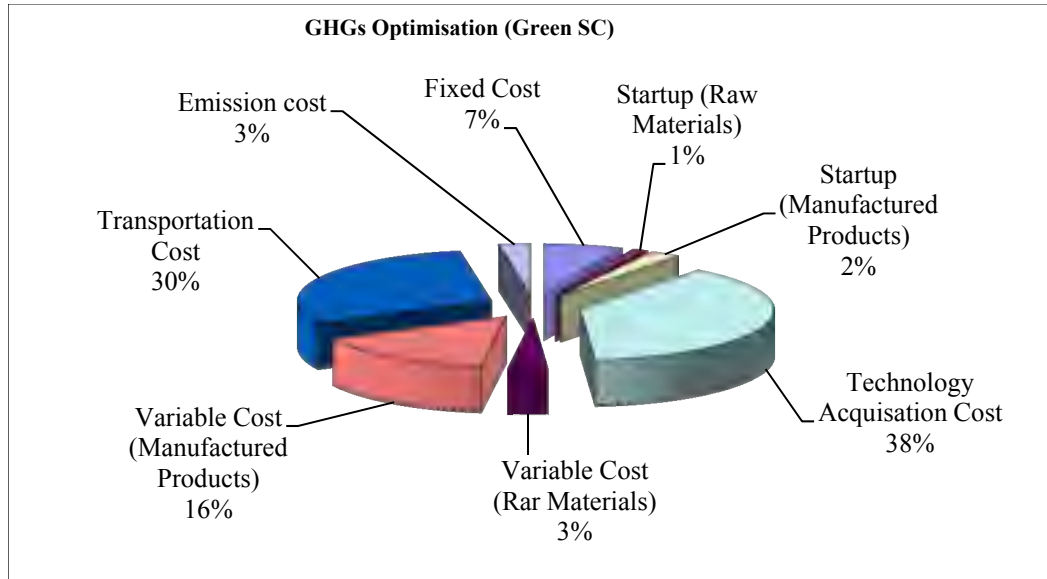

Figure A I-6 Cost breakdown for the optimal solution to F₂.

To observe the sensitivity of the total logistics cost to GHG emissions, constraint 31 is added to the model and solved for different values of $UB_{Emission}$. This represents an upper bound on tCO₂e.

$$\underbrace{\sum_{p \in M \cup R} \sum_{i \in S_p \cup V_p} \sum_{j \in S(Suc(P)) \cup D} \sum_{k \in K} \alpha^k \pi_p d(i, j) F_{ijp}^k}_{\text{GHGs Emissions from transportation}} + \underbrace{\sum_{p \in M} \sum_{i \in S_p} \sum_{g \in G_p} \beta_{ip}^g \pi_p Q_{ip}^g}_{\text{GHGs Emissions from process}} \leq UB_{Emission} \tag{A-31}$$

Figure 7 shows that the total logistics cost decreases with each increase in the upper bound of CO₂e emissions ($UB_{Emission}$) as the model seeks less costly solution alternatives which have higher emission rates. It stabilizes after a while. The selection of low cost technologies is observed (figure 5 and 6). From a managerial perspective, this means that those companies might have to look for new sourcing, production or transportation alternatives and invest in environmentally friendly technologies in order to reduce GHG emissions. In this example, GHG emissions are more than the cap for the green and the efficient scenarios, and there is a need to buy carbon credits form the market (emissions cost).

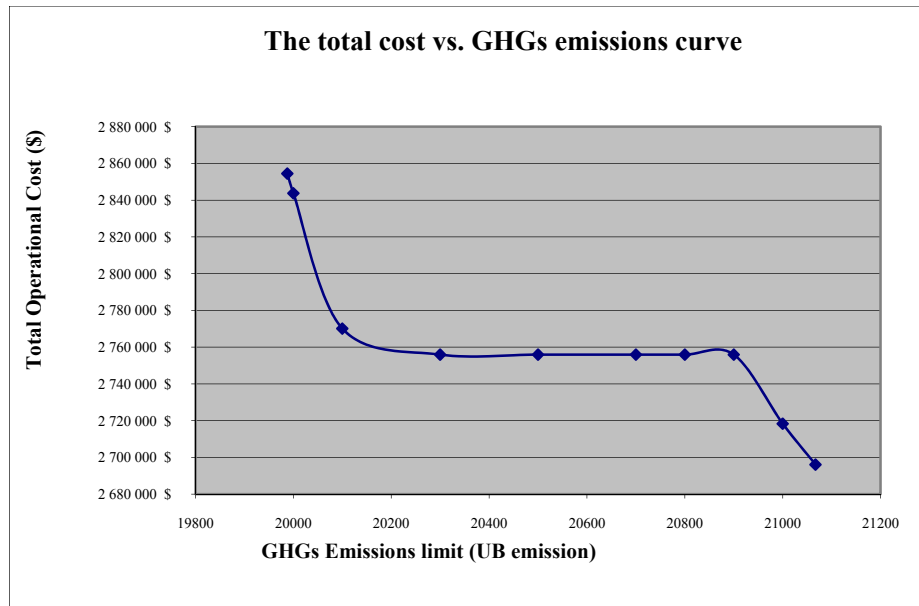

Figure A I-7 The Total Logistics Cost vs. CO₂ Curve.

Figure also shows that the total logistics cost (F_1) and carbon emissions (F_2) are two conflicting objectives. Thus, the application of a multi-objective optimization procedure could help to determine the best trade-offs.

Goal programming solution

Background on Multi-objective optimization

A general MOO problem can be formulated as follows :

$$\begin{aligned}
 &\text{Find : } \mathbf{x} = [x_1, x_2, \dots, x_n]^T \\
 &\text{to minimize: } F(\mathbf{x}) = [F_1(\mathbf{x}), F_2(\mathbf{x}), \dots, F_k(\mathbf{x})]^T \\
 &\text{subject to :} \\
 &g_j(\mathbf{x}) \leq 0; \forall j = 1, 2, \dots, m \\
 &h_l(\mathbf{x}) = 0; \forall l = 1, 2, \dots, e
 \end{aligned}
 \tag{A-32}$$

Where n is the number of design variables, k is the number of objective functions, m is the number of inequality constraints. $\mathbf{x} \in R^n$ is a vector of scalar design variables (also called decision variables) x_i . $\mathbf{F}(\mathbf{x}) \in R^k$ is a vector of scalar objective functions $F_i(\mathbf{x}): R^n \rightarrow R$ which are also called objectives, criteria, value functions, payoff functions, or cost functions. \mathbf{x}_i^* is the point that minimizes the scalar objective $F_i(\mathbf{x})$, and therefore, $F_i(\mathbf{x}_i^*)$ is the minimum value of the objective function $F_i(\mathbf{x})$. The feasible design space (often called the constraint set) \mathbf{X} is defined as the set $\{\mathbf{x} | g_j(\mathbf{x}) \leq 0; \forall j = 1, 2, \dots, m \text{ and } h_l(\mathbf{x}) = 0; \forall l = 1, 2, \dots, e\}$. The feasible criterion space \mathbf{Z} (also called the feasible cost space or the attainable set) is defined as the set $\{\mathbf{F}(\mathbf{x}) | \mathbf{x} \in \mathbf{X}\}$. Whereas the design space is defined in terms of the design variables, the criterion space is defined in terms of the objective functions (the criteria). Each $\mathbf{x} \in \mathbf{X}$ may be represented in R^k by a point with coordinates $F_1(\mathbf{x}), F_2(\mathbf{x}), \dots, F_k(\mathbf{x})$. Thus, the set of points defined by \mathbf{Z} is the image of \mathbf{X} in the criterion space. Feasible objective vectors, $\{\mathbf{F}(\mathbf{X}) | \mathbf{X} \in \mathbf{S}\}$ are denoted by \mathbf{Y} , so $\mathbf{F} : \mathbf{X} \rightarrow \mathbf{Z}$, \mathbf{X} is mapped by \mathbf{F} onto \mathbf{Z} . $\mathbf{Z} \in R^k$ is usually referred to as the attribute space, where \mathbf{Z} is the boundary of \mathbf{Z} . $F_1^*, F_2^*, \dots, F_k^*$ will be used to denote the individual minima of each respective objective function, and the utopian solution is defined as $\mathbf{F}^* = (F_1^*, F_2^*, \dots, F_k^*)^T$. As \mathbf{F}^* simultaneously minimizes all objectives, it is an **ideal solution** that is rarely feasible.

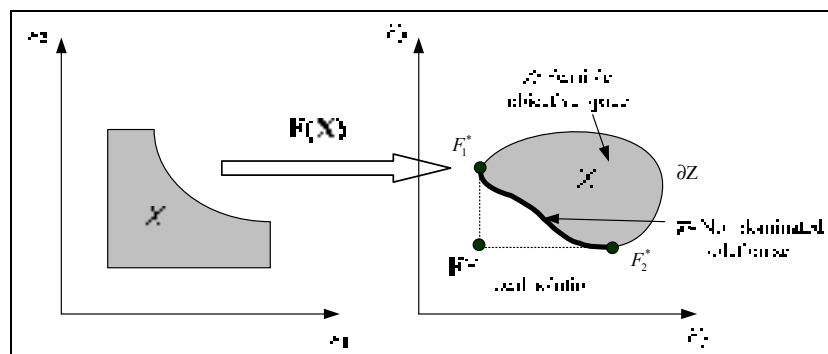

Figure A I-8 Ideal solution and non-dominated solution in a MOO.

The goal programming (GP) is the most common multi-objective optimization method. This probably is a consequence of the age of the method and of the intuitive nature of the fundamental formulation. GP is a vector optimization approach. Each objective function is treated independently. The goals b_j are specified for each objective function $F_j(\mathbf{x})$. Then, a function of the total deviation $\sum_{j=1}^k |d_j|$ is minimized, where d_j is the deviation from the goal b_j for the j^{th} objective. To model the absolute values, d_j is split into positive and negative parts such that $d_j = d_j^+ - d_j^-$ with $d_j^+ \geq 0, d_j^- \geq 0$, and $d_j^+ d_j^- = 0$. Consequently, $|d_j| = d_j^+ + d_j^-$. d_j^+ and d_j^- represent underachievement and overachievement, respectively, where achievement implies that a goal has been reached. A common, general formulation is given as follows (Cohon, 1978) :

$$\begin{aligned}
 & \text{Find : } \mathbf{x} = [x_1, x_2, \dots, x_n]^T, \mathbf{d}^+, \mathbf{d}^- \\
 & \text{to minimize: } \left[\sum_{j=1}^k (d_j^+ + d_j^-)^p \right]^{\frac{1}{p}} ; p \geq 1 \\
 & \text{subject to :} \\
 & F_j(\mathbf{x}) + d_j^+ - d_j^- = b_j ; \forall j = 1, 2, \dots, k \\
 & d_j^+ ; d_j^- \geq 0 ; \forall j = 1, 2, \dots, k \\
 & d_j^+ d_j^- = 0 ; \forall j = 1, 2, \dots, k \\
 & g_j(\mathbf{x}) \leq 0 ; \forall j = 1, 2, \dots, m \\
 & h_l(\mathbf{x}) = 0 ; \forall l = 1, 2, \dots, e
 \end{aligned} \tag{A-33}$$

p is often equal to one. And in the absence of any other information, we can consider that $b_j = F_j^* ; \forall j = 1, 2, \dots, k$.

Goal programming based optimization

The goal programming (GP) was used for the previous example in order to find the trade-offs between the total logistics cost and GHG emissions. Table 3 summarizes the various solutions.

Table A I-4
Goal Programming solution

Optimization scenarios	Total Operational Cost	tCO ₂ e
Efficient scenario - <i>Cost minimization</i>	$F_1^* = 2\,696\,051$ \$	$F_2 = 21\,067$
Green scenario - <i>GHG emissions minimization</i>	$F_1 = 2\,864\,915$ \$	$F_2^* = 19\,988$
Trade-offs scenario – <i>Goal programming</i>	$F_1 = 2\,718\,302$ \$	$F_2 = 20\,302$

This example demonstrates that by using a multi-objective approach, it is possible to achieve trade-offs with a good reduction in GHG emissions while maintaining operational costs under control.

Conclusion and future research

The main contribution of this paper is the development of an integrated model for GSCND problem leveraging the opportunities offered by carbon trading markets. It is the first model to our knowledge that integrates carbon prices explicitly in the GSCND. Using the model, supply chain managers are now able to access the GHG footprints of supply chains operations. They can determine if they qualify for carbon credits or must purchase credits on the carbon market place. That will help them decide on the best reconfiguration strategy for their supply chain. The quantification of the environmental impact was limited to CO₂. Emissions of other tradable GHG such Methane (CH₄) and Nitrous oxide (N₂O), can be integrated in the model by using known carbon conversion factors.

Finally, it is clear that GSCM will require a coherent and well planned long term strategy. The growing carbon legislation will create competitive carbon trading markets in different regions of the world and companies must learn to understand how to operate under these new rules and regulations. This is not going to be a just a “feel good” or marketing initiative, as it is driven by government regulation and customer demands. Assessing GHG emissions may have seemed strange five years ago, but is now a reality. This will significantly change how supply chains operate globally in an ever environmentally conscious world.

Appendix : Multi-Objective Optimization modeling approaches

Model (paper)	[[2]	[3]	[4]	[5]	[6]	[7]	[8]	[9]	[10]
Supply chain performances										
Traditional performances (objectives)										
Minimize cost / Maximize profit	*	*	*	*	*	*	*	*	*	*
Maximize the NPV									*	
Minimize investment in opening facilities										
Minimize resource utilization (capacity, inventory)		*						*		
Minimize financial risk									*	
Maximize service level					*		*	*	*	
Fast deliveries / Delivery promptness		*		*						
Minimize lead time / cycle time	*	*				*				
Maximize flexibility (Volume and delivery)				*	*					
Traffic access				*						
Green performances (objectives)										
Minimize transport pollution (CO,CO ₂ , NO _x , VOCs)				*		*				
Promotion of recycling / Waste elimination										*
Conservation of energy						*				
Minimize impact on environment from the entire SC				*						
Multi-objective techniques and methods										
Method 1 : no preference articulation										
Method 2 : priori articulation of preference	*	*		*		*	*	*		*
Method 3 : progressive articulation of preference										
Method 4 : posteriori articulation of preference					*					*

[1](Arntzen et al., 1995), [2] (Li and O'Brien, 1996), [3] (Giannikos, 1998), [4] (Min and Melachrinoudis, 1999), [5] (Sabri and Beamon, 2000), [6] (Luo et al., 2001), [7] (Nozick and Turnquist, 2001), [8] (Chen and Lee, 2004; Chen et al., 2003), [9] (G Guillen, 2005; G. Guillen et al., 2005)[10] (Sheu et al., 2005).

Model (paper)	[11]	[12]	[13]	[14]	[15]	[16]	[17]	[18]
Supply chain performances								
Traditional performances (objectives)								
Minimize cost / Maximize profit	*		*	*		*	*	*
Maximize the NPV		*						
Minimize investment in opening facilities		*						
Minimize resource utilization (capacity, inventory)				*				
Minimize financial risk								
Maximize service level	*			*				
Fast deliveries / Delivery promptness							*	
Minimize lead time / cycle time			*					
Maximize flexibility (Volume and delivery)								
Traffic access								
Green performances (objectives)								
Minimize transport pollution (CO, CO ₂ , Nox, VOCs)			*			*		*
Promotion of recycling / Waste elimination					*			*
Conservation of energy			*					
Minimize impact on environment from the entire SC		*			*			*
Multi-objective techniques and methods								
Method 1 : no preference articulation			*					*
Method 2 : priori articulation of preference								
Method 3 : progressive articulation of preference							*	
Method 4 : posteriori articulation of preference		*		*		*		

[11] (Shen and Daskin, 2005), [12] (Hugo and Pistikopoulos, 2005), [13] (Dotoli et al., 2005; Dotoli et al., 2006), [14] (Altiparmak et al., 2006), [15] (Lu et al., 2007) [15] (Lu et al., 2007), [16] (Ferretti et al., 2007), [17] (Pokharel, 2008), [18] (Frota Neto et al., 2008)

References

- Altıparmak, F., Gen, M., Lin, L., & Paksoy, T. (2006). A genetic algorithm approach for multi-objective optimization of supply chain networks. *Computational Intelligence and Information Technology : Applications to Industrial Engineering, Computers and Industrial Engineering*, 51(1), 196-215.
- Arntzen, B. C., Brown, G. G., Harrison, T. P., & Trafton, L. L. (1995). Global supply chain management at Digital Equipment Corporation. *Interfaces*, 25(1), 69-93.
- Chen, C.-L., & Lee, W.-C. (2004). Multi-objective optimization of multi-echelon supply chain networks with uncertain product demands and prices. *Computers and Chemical Engineering*, 28(6-7), 1131-1144.
- Chen, C.-L., Wang, B.-W., & Lee, W.-C. (2003). Multiobjective optimization for a multienterprise supply chain network. *Industrial and Engineering Chemistry Research*, 42(9), 1879-1889.
- Cohon, J. L. (1978). *Multiobjective programming and planning*. New York : Academic Press.
- Dotoli, M., Fanti, M. P., Meloni, C., & Zhou, M. C. (2005). A multi-level approach for network design of integrated supply chains. *International Journal of Production Research*, 43(20), 4267-4287.
- Dotoli, M., Fanti, M. P., Meloni, C., & Zhou, M. C. (2006). Design and optimization of integrated e-supply chain for agile and environmentally conscious manufacturing. *IEEE Transactions on Systems, Man, and Cybernetics Part A :Systems and Humans*, 36(1), 62-75.
- Facanha, C., & Horvath, A. (2007). Evaluation of Life-Cycle Air Emission Factors of Freight Transportation. *Environmental Science & Technology*, 41(20), 7138-7144.
- Ferretti, I., Zanoni, S., Zavanella, L., & Diana, A. (2007). Greening the aluminium supply chain. *International Journal of Production Economics*, 108(1-2), 236-245.
- Frota Neto, J. Q., Bloemhof-Ruwaard, J. M., van Nunen, J. A. E. E., & van Heck, E. (2008). Designing and evaluating sustainable logistics networks. *International Journal of Production Economics*, 111(2), 195-208.
- Giannikos, I. (1998). A multiobjective programming model for locating treatment sites and routing hazardous wastes, Puerto de La Cruz, Spain.

- Guillen, G. (2005a). Optimal offer proposal policy in an integrated supply chain management environment. *Industrial & engineering chemistry research*, 44(19), 7405-7419.
- Guillen, G., Mele, F. D., Bagajewicz, M. J., Espuna, A., & Puigjaner, L. (2005b). Multiobjective supply chain design under uncertainty. *Chemical Engineering Science*, 60(6), 1535-1553.
- Hugo, A., & Pistikopoulos, E. N. (2005). Environmentally conscious long-range planning and design of supply chain networks. *Journal of Cleaner Production : Recent advances in industrial process optimisation*, 13(15), 1471-1491.
- Jayaraman, V., Guide, V. D. R., Jr., & Srivastava, R. (1999). Closed-loop logistics model for remanufacturing. *Journal of the Operational Research Society*, 50(5), 497-508.
- Karan, C., & Philippe, A. (2008). State and trends of the carbon market 2008. Washington, D.C. : The World Banko. Document Number)
- Labatt, S., & White, R. R. (2007). Carbon finance : the financial implications of climate change. Hoboken, N.J. : John Wiley & Sons.
- Li, D., & O'Brien, C. (1996). Integrated decision modelling of supply chain efficiency. In Proceedings of the 1996 10th International Symposium on Inventory, Aug 1. Budapest, Hungary.
- Lu, L. Y. Y., Wu, C. H., & Kuo, T.-C. (2007). Environmental principles applicable to green supplier evaluation by using multi-objective decision analysis. Sustainable Design and Manufacture, *International Journal of Production Research*, 45(18-19), 4317-4331.
- Luo, Y., Zhou, M., & Caudill, R. J. (2001). An integrated E-supply chain model for agile and environmentally conscious manufacturing. *IEEE/ASME Transactions on Mechatronics*, 6(4), 377-386.
- Min, H., & Melachrinoudis, E. (1999). The relocation of a hybrid manufacturing/distribution facility from supply chain perspectives : a case study. *Omega*, 27(1), 75-85.
- Nozick, L. K., & Turnquist, M. A. (2001). Inventory, transportation, service quality and the location of distribution centers. *European Journal of Operational Research*, 129(2), 362-371.
- Pokharel, S. (2008). A two objective model for decision making in a supply chain. *International Journal of Production Economics*, 111(2), 378-388.

- Sabri, E. H., & Beamon, B. M. (2000). A multi-objective approach to simultaneous strategic and operational planning in supply chain design. *Omega*, 28(5), 581-598.
- Seuring, S., & Muller, M. (2008). From a literature review to a conceptual framework for sustainable supply chain management. *Journal of Cleaner Production*, 16(15), 1699-1710.
- Shen, Z.-J. M., & Daskin, M. S. (2005). Trade-offs between customer service and cost in integrated supply chain design. *Manufacturing and Service Operations Management*, 7(3), 188-207.
- Sheu, J.-B., Chou, Y.-H., & Hu, C.-C. (2005). An integrated logistics operational model for green-supply chain management. *Transportation Research Part E : Logistics and Transportation Review*, 41(4), 287-313.
- Srivastava, S. K. (2007). Green supply-chain management : A state-of-the-art literature review. *International Journal of Management Reviews*, 9(1), 53-80.

BIBLIOGRAPHY

- Albino, Vito, et Silvana Kühtz. 2004. « Enterprise input-output model for local sustainable development--the case of a tiles manufacturer in Italy ». *Resources, Conservation and Recycling*, vol. 41, n° 3, p. 165-176.
- Andersen, Mette, et Tage Skjoett-Larsen. 2009. « Corporate social responsibility in global supply chains ». *Supply Chain Management : An International Journal*, vol. 14, p. 75-86.
- Atalay Atasu, Luk N. Van Wassenhove et Miklos Sarvary. 2009. « Efficient Take-Back Legislation ». *Production and Operations Management*, vol. 18, n° 3, p. 243-258.
- Atasu, Atalay, Miklos Sarvary et Luk N. Van Wassenhove. 2008. « Remanufacturing as a Marketing Strategy ». *Management Science*, vol. 54, n° 10 (October 1, 2008), p. 1731-1746.
- Badurdeen, F., Iyengar, D., Goldsby, T.J., Jawahir, I.S., Metta, H., and Gupta, S., 2008, A 6R-based Approach to Next Generation Sustainable Supply Chain Management (submitted) to European Journal of Operational research, November, 2008.
- Baranzini, Andrea, José Goldemberg et Stefan Speck. 2000. « A future for carbon taxes ». *Ecological Economics*, vol. 32, n° 3, p. 395-412.
- Barker, Theresa J., et Zelda B. Zabinsky. 2008. « Reverse logistics network design : a conceptual framework for decision making ». *International Journal of Sustainable Engineering*, vol. 1, n° 4, p. 250-260.
- Bayon, Ricardo, Amanda Hawn et Katherine Hamilton. 2007. *Voluntary carbon markets : an international business guide to what they are and how they work*. London ; Sterling, Va. : Earthscan, xx, 164 p. p. <<http://www.loc.gov/catdir/toc/ecip0620/2006029027.html>>.
- Beamon, B. M. 1999. « Measuring supply chain performance ». *International Journal of Operations & Production Management*, vol. 19, p. 275.
- Beamon, B. M., et C. Fernandes. 2004. « Supply-chain network configuration for product recovery ». *Production Planning and Control*, vol. 15, n° 3, p. 270-81.

- Beynon, Malcolm J. 2008. « Constellation graphs and the role of rank position criteria value frontiers in PROMETHEE analysis ». *International Journal of Operational Research*, vol. 3, n° 1/2, p. 201-218.
- Blackhurst, Jennifer, Tong Wu et Peter O'Grady. 2005. « PCDM : a decision support modeling methodology for supply chain, product and process design decisions ». *Journal of Operations Management*, vol. 23, n° 3-4, p. 325-343.
- Brentrup, F., J. Küsters, H. Kuhlmann et J. Lammel. 2001. « Application of the Life Cycle Assessment methodology to agricultural production : an example of sugar beet production with different forms of nitrogen fertilisers ». *European Journal of Agronomy*, vol. 14, n° 3, p. 221-233.
- Burgess, K. 2006. « Supply chain management : a structured literature review and implications for future research ». *International Journal of Operations & Production Management*, vol. 26, n° 7, p. 703.
- Capar, Ismail, Fusun Ulengin et Arnold Reisman. 2004. *A Taxonomy for Supply Chain Management Literature*. SSRN. <<http://ssrn.com/paper=531902>>.
- Carter, C. R. 2008. « A framework of sustainable supply chain management : moving toward new theory ». *International Journal of Physical Distribution & Logistics Management*, vol. 38, n° 5, p. 360.
- Chen, Cheng-Liang, et Wen-Cheng Lee. 2004. « Multi-objective optimization of multi-echelon supply chain networks with uncertain product demands and prices ». *Computers and Chemical Engineering*, vol. 28, n° 6-7, p. 1131-1144.
- Chen, Cheng-Liang, Bin-Wei Wang et Wen-Cheng Lee. 2003. « Multiobjective optimization for a multienterprise supply chain network ». *Industrial and Engineering Chemistry Research*, vol. 42, n° 9, p. 1879-1889.
- Chopra, Sunil, et Peter Meindl. 2004. *Supply chain management : strategy, planning, and operation*, 2nd. Upper Saddle River, N.J. : Prentice Hall, xvii, 567 p. <<http://www.loc.gov/catdir/toc/fy041/2003004867.html>>.
- Cohon, Jared L. 1978. *Multiobjective programming and planning*. Coll. « Mathematics in science and engineering v. 140 ». New York : Academic Press, xiv, 333 p.
- Conrad, Klaus, et Robert E. Kohn. 1996. « The US market for SO2 permits : Policy implications of the low price and trading volume ». *Energy Policy*, vol. 24, n° 12, p. 1051-1059.

- Contreras, Ana M., Elena Rosa, Maylier Pérez, Herman Van Langenhove et Jo Dewulf. 2009. « Comparative Life Cycle Assessment of four alternatives for using by-products of cane sugar production ». *Journal of Cleaner Production*, vol. 17, n° 8, p. 772-779.
- Cooper, M. C. 1997. « Supply chain management : more than a new name for logistics ». *International Journal of Logistics Management*, vol. 8, p. 1.
- Craig, Shepherd. , et Günter. Hannes. 2006. « Measuring supply chain performance : current research and future directions ». *International Journal of Productivity and Performance Management*, vol. 55, n° 3, p. 242-258.
- Croom, Simon, Pietro Romano et Mihalis Giannakis. 2000. « Supply chain management : an analytical framework for critical literature review ». *European Journal of Purchasing & Supply Management*, vol. 6, n° 1 (2000/3), p. 67-83.
- De Benedetto, Luca, et Jiri Klemes. 2009. « The Environmental Performance Strategy Map : an integrated LCA approach to support the strategic decision-making process ». *Journal of Cleaner Production*, vol. 17, n° 10, p. 900-906.
- De Brito, Marisa P., et Rommert Dekker. 2003. *A Framework for Reverse Logistics*. SSRN. <<http://ssrn.com/paper=423654>>.
- Dekker, Rommert. 2004. *Reverse logistics : quantitative models for closed-loop supply chains*. Berlin ; New York : Springer, viii, 436 p. p.
- Dotoli, M. 2005. « A multi-level approach for network design of integrated supply chains ». *International journal of production research*, vol. 43, n° 20, p. 4267-4287.
- Dotoli, M., M. P. Fanti, C. Meloni et M. C. Zhou. 2005. « A multi-level approach for network design of integrated supply chains ». *International Journal of Production Research*, vol. 43, n° 20 (Oct 15), p. 4267-4287.
- Dotoli, M., M.P. Fanti, C. Meloni et M.C. Zhou. 2006. « Design and optimization of integrated e-supply chain for agile and environmentally conscious manufacturing ». *IEEE Transactions on Systems, Man, and Cybernetics Part A :Systems and Humans*, vol. 36, n° 1 (2006///), p. 62-75.
- Electronics Product Stewardship Canada (EPSC). 2009. « <http://www.epsc.ca/> ».
- Elkington, John. 1998. *Cannibals with forks : the triple bottom line of 21st century business*. Gabriola Island, BC ; Stony Creek, CT : New Society Publishers, xvi, 407 p. p.
- Expert Choice Inc. 2000. *Expert Choice Software 2000*. <http://www.expertchoice.com/>. <<http://www.expertchoice.com/>>.

- Facanha, C., et A. Horvath. 2007. « Evaluation of Life-Cycle Air Emission Factors of Freight Transportation ». *Environmental Science & Technology*, vol. 41, n° 20, p. 7138-7144.
- Faure, Michael, Joyeeta Gupta et A. Nentjes. 2003. *Climate change and the Kyoto protocol : the role of institutions and instruments to control global change*. Cheltenham, UK ; Northampton, MA : Edward Elgar Pub., xi, 361 p. p.
- Ferretti, I., S. Zaroni, L. Zavanella et A. Diana. 2007. « Greening the aluminium supply chain ». *International Journal of Production Economics*, vol. 108, n° 1-2 (2007/7), p. 236-245.
- Fleischmann, Bernhard, Herbert Meyr, A. G. de Kok et S. C. Graves. 2003. « Planning Hierarchy, Modeling and Advanced Planning Systems ». In *Handbooks in Operations Research and Management Science*. Vol. Volume 11, p. 455-523. Elsevier. <<http://www.sciencedirect.com/science/article/B7P6G-4FPHYXC-B/2/1ca0554dfa22d2f6697c90464888b608>>.
- Fleischmann, M. 2000. « A characterisation of logistics networks for product recovery ». *Omega : The International Journal of Management Science*, vol. 28, n° 6, p. 653.
- Fleischmann, Moritz, Jacqueline M. Bloemhof-Ruwaard, Rommert Dekker, Erwin van der Laan, Jo A. E. E. van Nunen et Luk N. Van Wassenhove. 1997. « Quantitative models for reverse logistics : A review ». *European Journal of Operational Research*, vol. 103, n° 1, p. 1-17.
- Fleischmann, Mortiz, Hans Ronald Krikke, Rommert Dekker et Simme Douwe P. Flapper. 2000. « A characterisation of logistics networks for product recovery ». *Omega*, vol. 28, n° 6, p. 653-666.
- Foran, Barney, Manfred Lenzen, Christopher Dey et Marcela Bilek. 2005. « Integrating sustainable chain management with triple bottom line accounting ». *Ecological Economics*, vol. 52, n° 2, p. 143-157.
- Frota Neto, J. Quariguasi, J. M. Bloemhof-Ruwaard, J. A. E. E. van Nunen et E. van Heck. 2008. « Designing and evaluating sustainable logistics networks ». *International Journal of Production Economics*, vol. 111, n° 2, p. 195-208.
- Giannikos, I. 1998. « A multiobjective programming model for locating treatment sites and routing hazardous wastes ». In, 2. Vol. 104, p. 333-42. Coll. « Eur. J. Oper. Res. (Netherlands) ». Puerto de La Cruz, Spain : Elsevier. <[http://dx.doi.org/10.1016/S0377-2217\(97\)00188-4](http://dx.doi.org/10.1016/S0377-2217(97)00188-4)>.

- Goetschalcks, Marc, et Bernhard Fleischmann. 2008. « Strategic Network Design ». In *Supply Chain Management and Advanced Planning*. p. 117-132. <http://dx.doi.org/10.1007/978-3-540-74512-9_7>.
- Graves, Stephen C, et Sean P Willems. 2000. « Optimizing Strategic Safety Stock Placement in Supply Chains ». *Manufacturing and Service Operations Management*, vol. 2, n° 1, p. 68-83.
- Guide, V. Daniel R., Jr. 2000. « Production planning and control for remanufacturing : Industry practice and research needs ». *Journal of Operations Management*, vol. 18, n° 4, p. 467-483.
- Guide, V. Daniel R., Jr., et Luk N. Van Wassenhove. 2009. « OR FORUM--The Evolution of Closed-Loop Supply Chain Research ». *OPERATIONS RESEARCH*, vol. 57, n° 1 (January 1, 2009), p. 10-18.
- Guillen-Gosalbez, Gonzalo, et Ignacio E. Grossmann. 2009. « Optimal design and planning of sustainable chemical supply chains under uncertainty ». *AIChE Journal*, vol. 55, n° 1, p. 99-121.
- Guillen, G., F.D. Mele, M.J. Bagajewicz, A. Espuna et L. Puigjaner. 2005. « Multiobjective supply chain design under uncertainty ». *Chemical Engineering Science*, vol. 60, n° 6, p. 1535-1553.
- Gunasekaran, A., C. Patel et Ronald E. McGaughey. 2004. « A framework for supply chain performance measurement ». *International Journal of Production Economics*, vol. 87, n° 3, p. 333-347.
- Gungor, Askiner, et Surendra M. Gupta. 1999. « Issues in environmentally conscious manufacturing and product recovery : a survey ». *Computers & Industrial Engineering*, vol. 36, n° 4, p. 811-853.
- Hagelaar, Geoffrey J. L. F., et Jack G. A. J. van der Vorst. 2001. « Environmental supply chain management : using life cycle assessment to structure supply chains ». *The International Food and Agribusiness Management Review*, vol. 4, n° 4, p. 399-412.
- Hokey Min, et William P. Galle. 1997. « Green Purchasing Strategies : Trends and Implications ». *The Journal of Supply Chain Management*, vol. 33, n° 3, p. 10-17.
- Hugo, A., et E.N. Pistikopoulos. 2005. « Environmentally conscious long-range planning and design of supply chain networks ». *Journal of Cleaner Production : Recent advances in industrial process optimisation*, vol. 13, n° 15, p. 1471-1491.

- Hugo, Andre, Paul Rutter, Stratos Pistikopoulos, Angelo Amorelli et Giorgio Zoia. 2005. « Hydrogen infrastructure strategic planning using multi-objective optimization ». *International Journal of Hydrogen Energy*, vol. 30, n° 15, p. 1523-1534.
- Humair, Salal, et Sean P. Willems. 2006. « Optimizing strategic safety stock placement in supply chains with clusters of commonality ». *Operations Research*, vol. 54, n° 4, p. 725-742.
- Humphreys, P. K., Y. K. Wong et F. T. S. Chan. 2003. « Integrating environmental criteria into the supplier selection process ». *Journal of Materials Processing Technology*, vol. 138, n° 1-3, p. 349-356.
- Hutchins, et M. J. Hutchins. 2008. « An exploration of measures of social sustainability and their application to supply chain decisions ». *Journal of Cleaner Production*, vol. 16, n° 15, p. 1688.
- Hutchins, Margot J., et John W. Sutherland. 2008. « An exploration of measures of social sustainability and their application to supply chain decisions ». *Journal of Cleaner Production*, vol. 16, n° 15, p. 1688-1698.
- Inderfurth, Karl, et Stefan Minner. 1998. « Safety stocks in multi-stage inventory systems under different service measures ». *European Journal of Operational Research*, vol. 106, n° 1, p. 57-73.
- Intergovernmental Panel on Climate Change. 2007. *Fourth Assessment Report, Climate Change 2007, Synthesis Report*
- ISO, *Environmental management – life cycle assessment – principles and framework*. 1997. Geneva, Switzerland [ISO 14040] : International Organisation for Standardisation,.
- Jayaraman, V., V. D. R. Guide, Jr. et R. Srivastava. 1999a. « Closed-loop logistics model for remanufacturing ». *Journal of the Operational Research Society*, vol. 50, n° 5, p. 497-508.
- Jayaraman, V., V. D. R. Guide et R. Srivastava. 1999b. « A closed-loop logistics model for remanufacturing ». *J Oper Res Soc*, vol. 50, n° 5, p. 497-508.
- Jayaraman, V., et H. Pirkul. 2001. « Planning and coordination of production and distribution facilities for multiple commodities ». *European Journal of Operational Research*, vol. 133, n° 2 (1 Sept. 2001), p. 394-408.
- Jayaraman, V., et A. Ross. 2003. « A simulated annealing methodology to distribution network design and management ». *European Journal of Operational Research*, vol. 144, n° 3 (2003/02/01), p. 629-45.

- Jayaraman, Vaidyanathan. 2006. « Production planning for closed-loop supply chains with product recovery and reuse : An analytical approach ». *International Journal of Production Research*, vol. 44, n° 5, p. 981-998.
- Johnson, Eric, et Russell Heinen. 2004. « Carbon trading : time for industry involvement ». *Environment International*, vol. 30, n° 2, p. 279-288.
- Karan, Capoor, et Ambrosi Philippe. 2008. *State and trends of the carbon market 2008*. Washington, D.C. : The World Bank.
- Karpak, Birsen, Erdogan Kumcu et Rammohan R. Kasuganti. 2001. « Purchasing materials in the supply chain : managing a multi-objective task ». *European Journal of Purchasing & Supply Management*, vol. 7, n° 3 (2001/9), p. 209-216.
- Keeney, Ralph L., et Howard Raiffa. 1976. *Decisions with multiple objectives preferences and value tradeoffs*. Coll. « Wiley series in probability and mathematical statistics ». New York : J. Wiley, 569 pages p.
- Krikke, H., J. Bloemhof-Ruwaard et L. N. Van Wassenhove. 2003. « Concurrent product and closed-loop supply chain design with an application to refrigerators ». *International Journal of Production Research*, vol. 41, n° 16, p. 3689 - 3719.
- Labatt, Sonia, et Rodney R. White. 2007. *Carbon finance : the financial implications of climate change*. Coll. « Wiley finance series. ». Hoboken, N.J. : John Wiley & Sons, xx, 268 p. p. <<http://www.loc.gov/catdir/toc/ecip072/2006033468.html>>.
- Lam, Hon Loong, Petar Varbanov et Jiri Klemes. 2009 « Minimising carbon footprint of regional biomass supply chains ». *Resources, Conservation and Recycling*, vol. In Press, Corrected Proof.
- Lebreton, Baptiste. 2007. *Strategic Closed-Loop Supply Chain Management*. Coll. « Lecture Notes in Economics and Mathematical Systems, », 586. Berlin, Heidelberg : Springer-Verlag Berlin Heidelberg.
- Lee, Hau L., et Corey Billington. 1993. « Material management in decentralized supply chains ». *Operations Research*, vol. 41, n° 5, p. 835-847.
- Lieckens, K., et N. Vandaele. 2007a. « Reverse logistics network design with stochastic lead times ». *Computers & Operations Research*, vol. 34, n° 2, p. 395-416.
- Lieckens, Kris, et Nico Vandaele. 2007b. « Reverse logistics network design with stochastic lead times ». *Computers and Operations Research*, vol. 34, n° 2, p. 395-416.
- Lippmann, S. 1999. « Supply Chain Environmental Management : Elements for Success ». *Corporate Environmental Strategy*, vol. 6, p. 175-182.

- Louwers, Dirk, Bert J. Kip, Edo Peters, Frans Souren et Simme Douwe P. Flapper. 1999. « A facility location allocation model for reusing carpet materials ». *Computers & Industrial Engineering*, vol. 36, n° 4, p. 855-869.
- Lu, Louis Y.Y., C.H. Wu et T.-C. Kuo. 2007. « Environmental principles applicable to green supplier evaluation by using multi-objective decision analysis ». *Sustainable Design and Manufacture, International Journal of Production Research*, vol. 45, n° 18-19, p. 4317-4331.
- Luo, Y., P. Wirojanagud et R.J. Caudill. 2001a. « Comparison of major environmental performance metrics and their application to typical electronic products ». In *2001 IEEE International Symposium on Electronics and the Environment, May 7-9 2001*. p. 94-99. Coll. « IEEE International Symposium on Electronics and the Environment ». Denver, CA : Institute of Electrical and Electronics Engineers Inc.
- Luo, Yanchun, MengChu Zhou et Reggie J. Caudill. 2001b. « An integrated E-supply chain model for agile and environmentally conscious manufacturing ». *IEEE/ASME Transactions on Mechatronics*, vol. 6, n° 4, p. 377-386.
- MacLean, Heather L., et Lester B. Lave. 2003. « Evaluating automobile fuel/propulsion system technologies ». *Progress in Energy and Combustion Science*, vol. 29, n° 1, p. 1-69.
- Magnanti, Thomas L., Zuo-Jun Max Shen, Jia Shu, David Simchi-Levi et Chung-Piaw Teo. 2006. « Inventory placement in acyclic supply chain networks ». *Operations Research Letters*, vol. 34, n° 2, p. 228-238.
- Maloni, Michael, et Michael Brown. 2006. « Corporate Social Responsibility in the Supply Chain : An Application in the Food Industry ». *Journal of Business Ethics*, vol. 68, n° 1, p. 35-52.
- Martel, Alain. 2005. « The design of production-distribution networks : A mathematical programming approach ». In *Supply Chain Optimization*, J. Geunes and P.M. Pardalos. Kluwer Academic Publishers,.
- Maxwell, D., et R. van der Vorst. 2003. « Developing sustainable products and services ». *Journal of Cleaner Production*, vol. 11, n° 8, p. 883-895.
- Meixell, Mary J., et Vidyananya B. Gargeya. 2005. « Global supply chain design : A literature review and critique ». *Transportation Research Part E : Logistics and Transportation Review*, vol. 41, n° 6, p. 531-550.
- Mellor, Warren, Elizabeth Wright, Roland Clift, Adisa Azapagic et Gary Stevens. 2002. « A mathematical model and decision-support framework for material recovery, recycling

- and cascaded use ». *Chemical Engineering Science*, vol. 57, n° 22-23 (2002/12//), p. 4697-4713.
- Mentzer, J. T. 2001. « Defining supply chain management ». *Journal of Business Logistics*, vol. 22, n° 2, p. 1.
- Metzer, John T., W. Dewitt, Keebler J.S., Min S., Nix N.W., Smith C.D. et Zacharia Z.G. 2001. « Defining Supply Chain Management ». *Journal of Business Logistics*, vol. 22, n° 2, p. 1-25.
- Meyr, Herbert, Michael Wagner et Jens Rohde. 2005. « Structure of Advanced Planning Systems ». In *Supply Chain Management and Advanced Planning*. p. 109-115. <http://dx.doi.org/10.1007/3-540-24814-5_6>.
- Michaelowa, Axel, et Frank Jotzo. 2005. « Transaction costs, institutional rigidities and the size of the clean development mechanism ». *Energy Policy*, vol. 33, n° 4, p. 511-523.
- Miller, Tan C. 2001. *Hierarchical operations and supply chain planning*. London ; New York : Springer, xi, 262 p. p.
- Min, Hokey, et Emanuel Melachrinoudis. 1999. « The relocation of a hybrid manufacturing/distribution facility from supply chain perspectives : a case study ». *Omega*, vol. 27, n° 1 (1999/2), p. 75-85.
- Minner, S. 1997. « Dynamic programming algorithms for multi-stage safety stock optimization ». *OR Spektrum*, vol. 19, n° 4 (1997//), p. 261-72.
- Nagurney, Anna. 2000. *Sustainable transportation networks*. Cheltenham, UK ; Northampton, MA : Edward Elgar, xvi, 286 p. p.
- Nagurney, Anna, Zugang Liu et Trisha Woolley. 2006. « Optimal endogenous carbon taxes for electric power supply chains with power plants ». *Mathematical and Computer Modelling*, vol. 44, n° 9-10, p. 899-916.
- Nagurney, Anna, Zugang Liu et Trisha Woolley. 2007. « Sustainable Supply Chain and Transportation Networks ». *International Journal of Sustainable Transportation*, vol. 1, n° 1, p. 29 - 51.
- New S.J, et P. Payne. 1995. « Research framework in logistics : three models, seven dinners and a survey ». *International Journal of Physical Distribution and logistics management*, vol. 25, n° 10.
- Ottman, Jacquelyn A., et NetLibrary Inc. 1998. *Green marketing [ressource électronique] : opportunity for innovation*, 2nd. Lincolnwood, Ill. : NTC Business Books, xviii, 270

p. p. <<http://www.netLibrary.com/urlapi.asp?action=summary&v=1&bookid=13312>>.

- Ozdamar, Linet, et Tulin Yazgac. 1999. « Hierarchical planning approach for a production-distribution system ». *International Journal of Production Research*, vol. 37, n° 16, p. 3759-3772.
- Paquet, Marc; Martel, Alain; Desaulniers, Guy. 2009 . «Including technology selection decisions in manufacturing network design models». *International Journal of Computer Integrated Manufacturing*, vol 17. n° 2, p. 117-125.
- Paul R. Kleindorfer, Kalyan Singhal et Luk N. Wassenhove. 2005. « Sustainable Operations Management ». *Production and Operations Management*, vol. 14, n° 4, p. 482-492.
- Peace, Janet, et Timothy Juliani. 2009. « The coming carbon market and its impact on the American economy ». *Policy and Society*, vol. 27, n° 4, p. 305-316.
- Pistikopoulos, E.N., et A. Hugo. 2005. « Environmentally conscious long-range planning and design of supply chain networks ». *Journal of Cleaner Production*, vol. 13, n° 15 (2005/12/), p. 1428-48.
- Pochampally, Kishore K., Satish Nukala et Surendra M. Gupta. 2009. *Strategic planning models for reverse and closed-loop supply chains*. Boca Raton : CRC Press, xvii, 273 p. p. <<http://www.library.gatech.edu:2048/login?url=http://www.engnetbase.com/ejournals/books/book%5Fsummary/summary.asp?id=7170>>.
- Poirier, C, et S.E. Reiter. 2001. *La supply chain*. Dunod, 2001.
- Pokharel, Shaligram. 2008. « A two objective model for decision making in a supply chain ». *International Journal of Production Economics*, vol. 111, n° 2 (2008/2), p. 378-388.
- Ramanathan, Ramu. 2003. *An introduction to data envelopment analysis : a tool for performance measurement*. New Delhi : Sage Publications, 201 p.
- Ramudhin, A., A. Chaabane, M. Kharoune et M. Paquet. 2008. « Carbon Market Sensitive Green Supply Chain Network Design ». In *IEEE International Conference on Industrial Engineering and Engineering Management, 2008. IEEM 2008*. p. 1093-1097.
- Ravi Subramanian, Sudheer Gupta et Brian Talbot. 2009. « Product Design and Supply Chain Coordination Under Extended Producer Responsibility ». *Production and Operations Management*, vol. 18, n° 3, p. 259-277.

- Rice, Gareth, Roland Clift et Richard Burns. 1997. « Comparison of currently available european LCA software ». *The International Journal of Life Cycle Assessment*, vol. 2, n° 1, p. 53-59.
- Robert Handfield, Robert Sroufe et Steven Walton. 2005. « Integrating environmental management and supply chain strategies ». *Business Strategy and the Environment*, vol. 14, n° 1, p. 1-19.
- Rohde, Jens. 2004. « Hierarchical supply chain planning using artificial neural networks to anticipate base-level outcomes ». *OR Spectrum*, vol. 26, n° 4, p. 471-492.
- Roy, Robin. 2000. « Sustainable product-service systems ». *Futures*, vol. 32, n° 3-4, p. 289-299.
- Rubio, Sergio, Antonio Chamorro et Francisco J. Miranda. 2008. « Characteristics of the research on reverse logistics (1995;2005) ». *International Journal of Production Research*, vol. 46, n° 4, p. 1099 - 1120.
- Saaty, Thomas L. 2001. *Decision making for leaders : the analytic hierarchy process for decisions in a complex world*, 3rd. Coll. « Analytic hierarchy process series vol. 2 ». Pittsburgh, PA : RWS Publications, xii, 315 p.
- Sabri, E.H., et B.M. Beamon. 2000. « A multi-objective approach to simultaneous strategic and operational planning in supply chain design ». *Omega*, vol. 28, n° 5 (2000/10/), p. 581-98.
- Sarkis, J. 2003. « A strategic decision framework for green supply chain management ». *Journal of Cleaner Production*, vol. 11, n° 4, p. 397.
- Sarmah, S.P. 2008. « Supply chain coordination with target profit ». *International Journal of Operational Research*, vol. 3, n° 1/2, p. 140 - 153.
- Savaskan, R. Canan, Shantanu Bhattacharya et Luk N. Van Wassenhove. 2004. « Closed-Loop Supply Chain Models with Product Remanufacturing ». *MANAGEMENT SCIENCE*, vol. 50, n° 2 (February 1, 2004), p. 239-252.
- Schärli, Alain. 1996. *Pratiquer Electre et Prométhée : un complément à Décider sur plusieurs critères*. Coll. « Collection Diriger l'entreprise ; 11 ». Lausanne, Suisse : Presses polytechniques et universitaires romandes, 173 p.
- Schultmann, Frank, Bernd Engels et Otto Rentz. 2004. « Flowsheeting-based simulation of recycling concepts in the metal industry ». *Journal of Cleaner Production*, vol. 12, n° 7, p. 737-751.

- Schultmann, Frank, Moritz Zumkeller et Otto Rentz. 2006. « Modeling reverse logistic tasks within closed-loop supply chains : An example from the automotive industry ». *European Journal of Operational Research*, vol. 171, n° 3, p. 1033-1050.
- Seuring, Stefan, et Martin Muller. 2008a. « Core issues in sustainable supply chain management - a Delphi study ». *Business Strategy and the Environment*, vol. 17, n° 8, p. 455-466.
- Seuring, Stefan, et Martin Muller. 2008b. « From a literature review to a conceptual framework for sustainable supply chain management ». *Journal of Cleaner Production*, vol. 16, n° 15, p. 1699-1710.
- Seuring, Stefan, Joseph Sarkis, Martin Muller et Purba Rao. 2008. « Sustainability and supply chain management - An introduction to the special issue ». *Journal of Cleaner Production*, vol. 16, n° 15, p. 1545-1551.
- Sheu, Jih-Biing. 2008. « Green supply chain management, reverse logistics and nuclear power generation ». *Transportation Research Part E : Logistics and Transportation Review*, vol. 44, n° 1 (2008/1), p. 19-46.
- Sheu, Jih-Biing, Yi-Hwa Chou et Chun-Chia Hu. 2005. « An integrated logistics operational model for green-supply chain management ». *Transportation Research Part E : Logistics and Transportation Review*, vol. 41, n° 4, p. 287-313.
- Simchi-Levi, David, et Yao Zhao. 2005. « Safety stock positioning in supply chains with stochastic lead times ». *Manufacturing and Service Operations Management*, vol. 7, n° 4, p. 295-318.
- Simpson, Jr., K.F. 1958. « In-process inventories ». *Operations Research*, vol. 6, n° 6, p. 863-873.
- Spriensma R. 2001. *The Eco-indicator 99 : a damage oriented method for life cycle impact assessment : methodology report*. Netherlands : PRé Consultants
- Srikanta, Routroy., et Sanisetty. Prasad. 2007. « Inventory planning for a multi-echelon supply chain ». *International Journal of Operational Research*, vol. 2, n° 3, p. 269-283.
- Srivastava, Samir K. 2007. « Green supply-chain management : A state-of-the-art literature review ». *International Journal of Management Reviews*, vol. 9, n° 1, p. 53-80.
- Srivastava, Samir K. 2008. « Network design for reverse logistics ». *Omega*, vol. 36, n° 4, p. 535-548.

- Stadtler, Hartmut, et Christoph Kilger. 2000. *Supply chain management and advanced planning : concepts, models, software, and case studies*. Berlin ; New York : Springer, xiii, 371 p. p.
- Steuer, Ralph E. 1986. *Multiple criteria optimization theory, computation, and application*. Coll. « Wiley series in probability and mathematical statistics ». New York ; Toronto : J. Wiley, xx, 546 p.
- Steve V. Walton, Robert B. Handfield et Steven A. Melnyk. 1998. « The Green Supply Chain : Integrating Suppliers into Environmental Management Processes ». *The Journal of Supply Chain Management*, vol. 34, n° 2, p. 2-11.
- Subramanian, Ravi, F. Brian Talbot et Sudheer Gupta. 2008. *An Approach to Integrating Environmental Considerations within Managerial Decision-Making*. SSRN eLibrary <http://ssrn.com/paper=1004339>.
- Supply Chain Council. 2006. « SCOR Model Overview ,Version 8.0. Supply Chain Council Inc. ».
- Syam, S.S. 2002. « A model and methodologies for the location problem with logistical components ». *Computers & Operations Research*, vol. 29, n° 9 (2002/08/), p. 1173-93.
- Tayur, Sridhar, Ram Ganeshan et Michael Magazine. 1999. *Quantitative models for supply chain management*. Coll. « International series in operations research & management science ; 17 ». Boston : Kluwer Academic Publishers, vii, 885 p. <<http://lcweb.loc.gov/catdir/toc/98037476.html>>.
- Tol, Richard S. J. 2005. « The marginal damage costs of carbon dioxide emissions : an assessment of the uncertainties ». *Energy Policy*, vol. 33, n° 16, p. 2064-2074.
- US Environmental Protection Agency. 2009. « <http://www.epa.gov/lawsregs/bizsector/index.html> ».
- Wadhwa, S., J. Madaan et F. T. S. Chan. 2009. « Flexible decision modeling of reverse logistics system : a value adding MCDM approach for alternative selection ». *Robotics and Computer-Integrated Manufacturing*, vol. 25, n° 2, p. 460-9.
- Wara, Michael. 2007. « Is the global carbon market working? ». *Nature*, vol. 445, n° 7128, p. 595-596.
- Waste Electronic and Elctrical Equipment*. 2009. « http://ec.europa.eu/environment/waste/weee/index_en.htm ».

- White, Charles David, Eric Masanet, Christine Meisner Rosen et Sara L. Beckman. 2003. « Product recovery with some byte : an overview of management challenges and environmental consequences in reverse manufacturing for the computer industry ». *Journal of Cleaner Production*, vol. 11, n° 4, p. 445-458.
- Woerdman, Edwin. 2000. « Implementing the Kyoto protocol : why JI and CDM show more promise than international emissions trading ». *Energy Policy*, vol. 28, n° 1, p. 29-38.
- Xanthopoulos, A., et E. Iakovou. 2009. « On the optimal design of the disassembly and recovery processes ». *Waste Management*, vol. 29, n° 5, p. 1702-1711.
- Yoon, Kwangsun, et C. L. Hwang. 1995. *Multiple attribute decision making : an introduction*. Coll. « Sage university papers series. Quantitative applications in the social sciences ; no. 07-104 ». Thousand Oaks, CA : Sage Publications, viii, 75 p.
- Young, A., et A. Kielkiewicz-Young. 2001. « Sustainable Supply Network Management ». *Corporate Environmental Strategy*, vol. 8, p. 260-268.
- Zhou, Zhangyu, Siwei Cheng et Ben Hua. 2000. « Supply chain optimization of continuous process industries with sustainability considerations ». In *7th International Symposium on Process Systems Engineering, 16-21 July 2000 (2000//)*. Vol. 24, p. 1151-8. Coll. « Comput. Chem. Eng. (UK) ». Keystone, CO, USA : Elsevier.
- Zhou, Zhangyu, Min'gang Zeng, Siwei Zeng, Ben Hua et Qinghua Yin. 2003. « Supply chain long range planning and investment decision making system in chemical industry ». *Huagong Xuebao/Journal of Chemical Industry and Engineering (China)*, vol. 54, n° 5, p. 659-664.