

Impact of directional antennas on routing and neighbor discovery
in wireless ad-hoc networks

by

Gabriel ASTUDILLO BROCEL

THESIS PRESENTED TO ÉCOLE DE TECHNOLOGIE SUPÉRIEURE
IN PARTIAL FULFILLMENT FOR THE DEGREE OF
DOCTOR OF PHILOSOPHY
Ph. D.

MONTREAL, SEPTEMBER 7, 2017

ÉCOLE DE TECHNOLOGIE SUPÉRIEURE
UNIVERSITÉ DU QUÉBEC



Gabriel Astudillo, 2017



This Creative Commons license allows readers to download this work and share it with others as long as the author is credited. The content of this work cannot be modified in any way or used commercially.

BOARD OF EXAMINERS

THIS THESIS HAS BEEN EVALUATED

BY THE FOLLOWING BOARD OF EXAMINERS

M. Michel Kadoch, Thesis Supervisor
Département de génie électrique à l'École de technologie supérieure

M. Suryn Witold, President of the Board of Examiners
Département de génie logiciel et des TI à l'École de technologie supérieure

M. Zbigniew Dziong, Member of the jury
Département de génie électrique à l'École de technologie supérieure

M. Rommel Torres, External Independent Examiner
Electronics and Computer Science Department at Universidad Tecnica Particular de Loja

THIS THESIS WAS PRESENTED AND DEFENDED

IN THE PRESENCE OF A BOARD OF EXAMINERS AND THE PUBLIC

ON AUGUST 8, 2017

AT ÉCOLE DE TECHNOLOGIE SUPÉRIEURE

ACKNOWLEDGEMENTS

First and foremost, I would like to thank God for giving me the opportunity and the strength to undertake this research study and to persevere until its completion. My gratitude also goes to my wife Johanna and my daughter Nathalia who have filled my life with love and supported me during all these years. Simply said, I owe them all and any success in my life.

Then, I would like to express my deepest gratitude to my supervisor Prof. Michel Kadoch for his continuous support, insightful guidance, and inspirational mentorship. Thank you for your opportune advice and for always encouraging me during my PhD. study.

I would also like to thank Prof. Surn Witold, Prof. Rommel Torres and Prof. Zbigniew Dziong for being part of my jury's committee, your advice was a key factor in the completion of this work.

Last, but not least, I would like to thank my friends and family for their support and help during the duration of my studies.

IMPACT DES ANTENNES DIRECTIONNELLES SUR LE ROUTAGE ET LA DÉCOUVERTE DE VOISINS DANS LES RÉSEAUX AD HOC SANS FIL

Gabriel ASTUDILLO BROCEL

RÉSUMÉ

Les réseaux ad hoc sans fil sont réseaux de données qui sont déployés sans infrastructure fixe ni de contrôleurs centraux tels que les points d'accès ou les stations de base. Dans ces réseaux, les paquets de données sont transmis directement au nœud de destination s'ils se situent dans la plage de transmission de l'émetteur ou envoyés par nœuds intermédiaires agissant comme relais. Ce paradigme, où une infrastructure fixe n'est pas nécessaire, est tolérant aux changements de topologie, et permet un déploiement rapide a été considéré comme une technologie prometteuse qui convient à un grand nombre d'implémentations de réseau, telles que les appareils portatifs, les capteurs sans fil et les réseaux de reprise après sinistres.

Récemment, les antennes directionnelles intelligentes ont été identifiées comme une technologie robuste qui peut améliorer la performance des réseaux ad hoc sans fil en termes de couverture, de connectivité et de capacité. Contrairement aux antennes omnidirectionnelles qui rayonnent de l'énergie dans toutes les directions, les antennes directionnelles peuvent focaliser l'énergie dans une direction spécifique, en étendant la plage de couverture pour la même puissance irradiée. Les gammes plus longues offrent des chemins plus courts aux autres nœuds et améliorent également la connectivité. De plus, les antennes directionnelles peuvent réduire le nombre de collisions dans un schéma d'accès basé sur les contentions, car elles peuvent diriger le lobe principal dans la direction souhaitée et définir tous les autres comme nuls, réduisant ainsi les interférences co-canal et réduisant le niveau de bruit. Les connexions sont plus fiables en raison de la stabilité accrue des liaisons et de la diversité spatiale. Des chemins plus courts, ainsi que des chemins alternatifs, sont également disponibles en raison de l'utilisation d'antennes directionnelles.

La plupart des recherches antérieures se sont focalisés sur l'adaptation des protocoles de contrôle d'accès au media et d'acheminement existants pour utiliser les communications directionnelles. Ce travail de recherche est authentique car il améliore le processus de découverte du voisin parce que il permet de découvrir des nœuds dans le deuxième voisinage d'un nœud donné, en utilisant une procédure gossip-based et il permet de partager l'information de position relative obtenue au cours de cette étape avec le protocole de routage. Nous avons également développé un modèle pour évaluer l'énergie consommée par les nœuds lorsque des antennes directionnelles intelligentes sont utilisées dans le réseau ad-hoc. Cette étude a démontré qu'en adaptant l'ouverture du faisceau des antennes, les nœuds sont capables d'atteindre les nœuds les plus éloignés et par conséquent, diminuer le nombre de sauts entre la source et la destination. Ceci va améliorer non seulement le performance du réseau, mais réduit également l'énergie moyenne consommée par l'ensemble du réseau.

Mots clés: antennes intelligentes, routage, réseaux ad-hoc, découverte du voisin

IMPACT OF DIRECTIONAL ANTENNAS ON ROUTING AND NEIGHBOR DISCOVERY IN WIRELESS AD-HOC NETWORKS

Gabriel ASTUDILLO BROCEL

ABSTRACT

Wireless ad-hoc networks are data networks that are deployed without a fixed infrastructure nor central controllers such as access points or base stations. In these networks, data packets are forwarded directly to the destination node if they are within the transmission range of the sender or sent through a multi-hop path of intermediary nodes that act as relays. This paradigm where a fixed infrastructure is not needed, is tolerant to topology changes and allows a fast deployment have been considered as a promissory technology that is suitable for a large number of network implementations, such as mobile hand-held devices, wireless sensors, disaster recovery networks, etc.

Recently, smart directional antennas have been identified as a robust technology that can boost the performance of wireless ad-hoc networks in terms of coverage, connectivity, and capacity. Contrary to omnidirectional antennas, which can radiate energy in all directions, directional antennas can focus the energy in a specific direction, extending the coverage range for the same power level. Longer ranges provide shorter paths to destination nodes and also improve connectivity. Moreover, directional antennas can reduce the number of collisions in a contention-based access scheme as they can steer the main lobe in the desired direction and set nulls in all the others, thereby they minimize the co-channel interference and reduce the noise level. Connections are more reliable due to the increased link stability and spatial diversity. Shorter paths, as well as alternative paths, are also available as a consequence of the use of directional antennas. All these features combined results in a higher network capacity.

Most of the previous research has focused on adapting the existing medium access control and routing protocols to utilize directional communications. This research work is novel because it improves the neighbor discovery process as it allows to discover nodes in the second neighborhood of a given node using a gossip based procedure and by sharing the relative position information obtained during this stage with the routing protocol with the aim of reducing the number of hops between source and destination. We have also developed a model to evaluate the energy consumed by the nodes when smart directional antennas are used in the ad-hoc network. This study has demonstrated that by adapting the beamwidth of the antennas nodes are able to reach furthest nodes and consequently, reduce the number of hops between source and destination. This fact not only reduces the end-to-end delay and improves the network throughput but also reduces the average energy consumed by the whole network.

Keywords: ad-hoc networks, routing, neighbor discovery, energy models, directional antennas

TABLE OF CONTENTS

	Page
CHAPTER 1 INTRODUCTION	1
1.1 Problem Statement	2
1.2 Objectives	3
1.3 Methodology	4
1.4 Thesis Contributions	5
1.5 Thesis Outline	6
CHAPTER 2 LITERATURE REVIEW AND BACKGROUND	9
2.1 Introduction	9
2.2 Ad-hoc Networks Basics	9
2.2.1 Applications of Ad-hoc Networks	10
2.2.2 Design and Research Challenges	14
2.2.3 Requirements	15
2.3 Smart antennas technologies	17
2.3.1 Introduction	17
2.3.2 Benefits of Smart Antenna Technologies	17
2.3.3 Foundation of smart antenna technology	19
2.4 Literature Review	25
2.4.1 Modeling ad-hoc networks	25
2.4.2 Neighborhood Discovery	27
2.4.3 Routing Algorithms	30
2.4.4 Energy Models	32
CHAPTER 3 MODELING DIRECTIONALITY IN WIRELESS AD-HOC NETWORKS	35
3.1 Introduction	35
3.2 Graph theory and Ad-hoc Networks	36
3.3 System Model	36
3.3.1 Node Distribution Model	37
3.3.2 Network Topology	37
3.3.3 Antenna model	37
3.3.4 Wireless Channel Model	39
3.4 Simulation Setup	42
3.5 Analysis of Results	44
3.5.1 Link Probability	44
3.5.2 Hop count	46
CHAPTER 4 NEIGHBOR DISCOVERY AND ROUTING SCHEMES FOR AD-HOC NETWORKS	51
4.1 Introduction	51

4.2	Overview	52
4.2.1	Neighbor Discovery	52
4.2.2	Routing Algorithms	54
4.3	System Model	55
4.3.1	Antenna Model	55
4.3.2	Beamforming	57
4.4	Proposed Solution	59
4.4.1	Neighbor discovery	60
4.4.2	Directional Routing	62
4.4.3	Route Discovery	64
4.4.4	Route Establishment	65
4.5	Simulation Setup	66
4.6	Results Analysis	67
4.6.1	Average end to end delay	67
4.6.2	Packet loss fraction	68
4.6.3	Throughput	69
CHAPTER 5	ENERGY MODEL FOR DIRECTIONAL AD-HOC NETWORKS	
	71
5.1	Introduction	71
5.2	Proposed Model	71
5.2.1	Node Distribution Model	72
5.2.2	Network Topology	72
5.2.3	Antenna model	72
5.2.4	Wireless Channel Model	73
5.2.5	Graph Representation Matrix	74
5.2.6	Routing scheme	74
5.3	Energy Cost of Communication	76
5.3.1	Omnidirectional Energy Cost	77
5.3.2	Directional Energy Cost	79
5.4	Energy model for messages transmitted	82
5.5	Simulation Setup	87
5.6	Results Analysis	88
CONCLUSION AND RECOMMENDATIONS	91
APPENDIX I	LIST OF PUBLICATIONS	95
BIBLIOGRAPHY	96

LIST OF TABLES

	Page
Table 3.1	Position of the nodes array 37
Table 3.2	Effective Beamforming Gain 41
Table 4.1	Simulations setup 67
Table 5.1	Position of the nodes array 72
Table 5.2	Number of messages matrix 79
Table 5.3	IEEE 802.11 MAC and PHY parameters 84
Table 5.4	MRF24WG0MA/MB Parameters 86

LIST OF FIGURES

	Page
Figure 2.1	Mobile ad-hoc network topology 10
Figure 2.2	Community mesh network topology 12
Figure 2.3	Opportunistic ad-hoc network 13
Figure 2.4	Device to Device Communications in 5G 14
Figure 2.5	Smart directional antenna schematic 20
Figure 2.6	Two infinitesimal dipoles 21
Figure 2.7	Circular array of N elements 22
Figure 2.8	AF elevation pattern for beamsteered circular array 23
Figure 2.9	An adaptive array structure 24
Figure 2.10	Graph representation with omnidirectional antennas 27
Figure 3.1	Antenna array installed in wireless nodes 38
Figure 3.2	Different link models and resulting network topologies 42
Figure 3.3	Link probability comparisons 45
Figure 3.4	Nodes and links over a service area for different antenna configurations 47
Figure 3.5	Hopcount comparison: omnidirectional vs. directional model 48
Figure 4.1	Antenna model for the switched beam array 56
Figure 4.2	Angle vs distance relationship 57
Figure 4.3	Omnidirectional vs. directional range 60
Figure 4.4	Antenna clockwise scan 61
Figure 4.5	Route discovery with omnidirectional antennas 65
Figure 4.6	Route establishment with directional antennas 66

Figure 4.7	Average end-to-end delay	68
Figure 4.8	Packet lost	69
Figure 4.9	Throughput	70
Figure 5.1	Node distribution and connectivity.....	74
Figure 5.2	Several iterations from node 25	76
Figure 5.3	Unicast cost with omnidirectional antennas	77
Figure 5.4	Unicast cost with directional antennas	80
Figure 5.5	Successful frame transmission under 802.11b.....	83
Figure 5.6	Number of transmitted messages per node	87
Figure 5.7	Total Energy Consumed: 50 Nodes scenario	88
Figure 5.8	Total Energy Consumed: 100 Nodes scenario.....	89
Figure 5.9	Total Energy Consumed: 500 Nodes scenario.....	90

LIST OF ALGORITHMS

	Page
Algorithm 3.1 Find Neighbors Function	43
Algorithm 4.1 4-way handshaking with extended range	63

LIST OF ABBREVIATIONS

AE	Average Energy Matrix
ACK	Acknowledge Message
AODV	Ad-hoc On Demand Distance Vector
CTS	Clear To Send Signal
CRC	Cyclic Redundancy Check
CSMA/CA	Carrier Sense Multiple Access / Collision Avoidance
CW	Contention Window
DIFS	Distributed Inter Frame Space
DSR	Dynamic Source Routing
DO	Directional-Omnidirectional
DD	Directional-Directional
DSP	Digital Signal Processor
DRX-AODV	Directional with Extended Range AODV
FDMA	Frequency Division Multiple Access
FSO	Free Space Optical
GPS	Global Positioning System
IEEE	Institute of Electrical and Electronic Engineers
LAR	Location Aided Routing
LEOD	Location Enhanced on Demand Protocol

XX

MAC	Medium Access Control
MANET	Mobile Ad-hoc Network
MSE	Minimum Square
NB	Neighbor Discovery
N-BF	Beam Forming
NS3	Network Simulator version 3
OD	Omnidirectional-Directional
PEER	Progressive Energy-Efficient Routing
RREQ	Route Request Packet
RREP	Route Reply Packet
RTS	Request To Send Signal
SIFS	Short Inter Frame Space
SP	Signal Processor
SIR	Signal to Interference Ratio
SDMA	Spatial Division Multiple Access
TDMA	Time Division Multiple Access
TE	Total Energy Matrix
TCP	Transfer Control Protocol
TCP/IP	Transfer Control / Internet Protocol
TBRPF	Topology Dissemination Based on Reverse-path Forwarding

WSN	Wireless Sensor Networks
WMA	Wireless Multicast Advantage
WMN	Wireless Mesh Networks

LISTE OF SYMBOLS AND UNITS OF MEASUREMENTS

P_r	Power received
P_t	Power transmitted
G_r	Reception Antenna Gain
G_t	Transmission Antenna Gain
PL	Power Losses
P_{rmin}	Minimum power received
γ	Threshold
$PL(d_0)$	Power Losses at reference distance d_0
d_0	Reference distance
E_θ	Electric field
ϕ	Electrical phase difference
θ	Angle
w_n	Beam former weight n
δ_n	Phase n
θ_0	Angel of reference
$w_{k,i}$	weight vector
r_0	Reference distance
ρ	Node density
$p(r_{ij})$	link probability between node i and j

d_{ij}	Distance between node i and j
$G(V, E)$	Graph of V vertices and E edges
$\Omega(M, M)$	Coverage Area of $M \times M$
d_0	Reference distance

CHAPTER 1

INTRODUCTION

From a general point of view a wireless ad-hoc network interconnects static or mobile nodes with wireless links and if required it can implement gateway functions to other types of networks such as cellular, broadband access, the Internet and many others. The major characteristic of this type of network is the wireless multi-hop architecture implemented in the network. The self-configuring capacity, low upfront cost, and ease of deployment have drawn a lot of attention from the international research community during the last decade. Despite these advantages, wireless ad-hoc networks face several issues particularly when the size of the network increases considerably (scalability issues) and when the velocity of the nodes increases (mobility issues).

There has been a recent trend in wireless ad-hoc networks in order to increase the scalability, efficient spectral reuse, and higher achievable bandwidth: the introduction of directionality in the communication methods (e.g. smart directional antennas, sectored antennas and free-space-optical transceivers). The improvements that can be achieved are promising and it becomes interesting to investigate how directionality can be successfully implemented in wireless ad-hoc networks. In this thesis, we analyze the improvement that can be achieved when smart directional antennas are used in ad-hoc networks.

Although a lot of work has been done on this subject, most of the previous research has focused on adapting existing MAC and routing protocols to utilize directional communications. To the best of our knowledge, our work is novel because it improves the neighbor discovery process as it allows to discover nodes in the second neighborhood of a given node using a gossip based procedure and by sharing the relative position information obtained during this stage with the routing protocol with the aim to reduce the number of hops between source and destination.

We have also developed a model to evaluate the energy consumed by the nodes when smart directional antennas are used in the ad-hoc network. The goal of this thesis is to prove that by

adapting the beamwidth of the antennas to reach the farthest nodes and consequently, reducing the number of hops between source and destination not only reduces the end-to-end delay and improves the network throughput, but it also reduces the whole network's average energy consumed.

1.1 Problem Statement

In recent years, wireless ad-hoc networks have emerged as a promising technology for Internet broadband access, community data networks, disaster recovery, vehicular and military networks due to its ease of deployment and low up-front investment. Exploiting this advantages requires new protocols and mechanisms at various communication layers to efficiently control the directional antenna beam. With directional antennas many trivial mechanisms such as neighborhood discovery and routing mechanisms become challenging. In this section we will identify and describe these issues:

- **Directional modeling of transmissions in ad-hoc networks:** Due to the absence of commercial solutions and the complexity of the ad-hoc scenarios, simulations have emerged as a widely accepted method to evaluate the performance of ad-hoc networks. However, simulation models can not always provide a deep understanding of the relationship between network performance and specific parameters. For this reason, many recent research efforts have considered the use of mathematical models to better explain the aforementioned relationships. Nevertheless, more of the previous work considered omnidirectional transmissions in the models and we have identified that there are very few models that consider the directional transmission in the mathematical model of ad-hoc networks;
- **Path length reduction with directional beams:** When the number of nodes in the network increases, the number of hops needed to reach distant nodes also increases. Besides, when a packet arrives at a node it needs to be processed to determine the next hop, this procedure increases the delay in the information delivery. Therefore each hop contributes to the delay related to packet processing, route calculation, and propagation. As consequence, the

end-to-end delay increases as well. We propose to develop neighbor discovery methods that consider the nodes that are located in the second-hop neighborhood of a node using directional antennas and mechanism that reduce the number of hops in a route between a source and destination devices by using the extended range that can be achieved when the nodes are equipped with directional antennas. To extend the antenna range the beams can be narrowed instead of increasing the power irradiated;

- **Energy modeling of directional antennas in ad-hoc networks:** Once the routes are shortened as consequence of the use of directional antennas, the next evident problem to address is to evaluate the reduction in the energy consumed by the wireless ad-hoc network as consequence of the use of directional antennas. To accomplish this task, it is necessary to conceive an appropriate model that considers the directional antennas on the energy model. We proposed an energy consumption model for ad-hoc networks with directional antennas using graph theory.

1.2 Objectives

The general objective of this thesis is to evaluate the improvement in the network performance that can be achieved when smart antennas are incorporated in wireless ad-hoc networks. Consequently, the first main objective is to develop a model that considers the directionality of the smart antennas installed in the nodes and then evaluate the impact of this technology on the connectivity of the ad-hoc network.

The second main objective is to develop and evaluate mechanisms to make a more efficient use of the directional antennas in ad-hoc networks. Furthermore, this can be divided into two specific objectives. The first specific objective is to conceive a new neighborhood discovery method that allows discovering more neighbors in less time using the longer ranges provided by the directional beams. The second specific objective is to develop a routing algorithm that uses adaptive beams to reach the farthest nodes in order to reduce the number of hops in a path between a source and destination nodes and consequently reduce the end-to-end delay.

The third main objective is to develop a model for the energy consumption on ad-hoc networks when the smart directional antennas are used on the nodes. Then, the model should be used to determine the amount of energy that can be saved when the smart antenna technology is used in ad-hoc networks.

1.3 Methodology

In this research, we study new ways of using smart directional antennas in ad-hoc networks. Specifically, on the neighbor discovery mechanism and on the routing protocol. These problems are addressed in three stages.

In the first stage, we address the problem of modeling the impact of directional antennas on the connectivity of ad-hoc networks. The model should consider the effect of directionality on the link probability and analyze its consequences on the network connectivity. Thus, this stage consist of two components: The link probability model, which should be expressed as a function of the antenna gains installed in the nodes, and the connectivity model that is determined as a function of the average hop count in the wireless network.

We propose to model these problems using graph theory, since literature survey reveals that mathematical model of ad-hoc networks is gaining considerable attention as alternative to simulation based models (Németh and Vattay (2003); Glauche et al. (2003)). In fact, graph theory is a widely used tool to model many types of relations and processes in physical, social and information systems. Emphasizing its application to real-world systems, the term network is sometimes defined to mean a graph in which attributes are associated with the nodes and edges.

In the second stage, we develop two algorithms that attempt to take full advantage of the capabilities of smart antennas. The first algorithm aims at increasing the number of discovered nodes by considering the nodes that are located in the second-hop neighborhood of a node (gossip-based algorithm with directional antennas). The second algorithm seeks to reduce the number of hops in a route between source and destination devices by using the extended range that can be achieved when the nodes are equipped with directional antennas. To extend the

antenna range, we propose to narrow the antenna beam instead of increase the power irradiated. This will reduce the energy consumption and reduce the number of retransmissions as a consequence of the packet collisions.

The third stage attempts to evaluate the reduction in the energy consumed by the wireless ad-hoc network as consequence of the implementation of the two algorithms proposed in the second stage. To accomplish this task it is necessary to conceive an appropriate model that considers the directional antennas on the energy model. Following the methodology used in the first stage, a novel energy consumption model for ad-hoc networks with directional antennas using Graph Theory is proposed.

The graph theoretical models are implemented using MATLAB version 2013A and the Graph Theory (GT) Toolbox; the routing models are also implemented on MATLAB with the support of the Network Analysis and Visualization toolbox.

1.4 Thesis Contributions

As result of the objectives presented in this thesis and following the proposed methodology, this research work makes the following novel contributions:

- a directional link probability model that considers the antenna gains is used as a function to weight the edges of a geometric random graph representation of a wireless ad-hoc network; then, the connectivity of the network is evaluated in terms of the number of the hops in a route (C-2);
- a novel neighbor discovery mechanism that uses a gossip-based mechanism to discover nodes in the second neighborhood of a node, and uses the extended range of directional antennas to reach farthest nodes(J-1);
- a routing algorithm that efficiently reduces the number of hops during the route discovery using the information provided by the neighbor discovery algorithm also proposed in this thesis (C-1 and J-1);

- an energy model that considers the directionality of the antennas in the function used to weight the edges of a random graph and then, the energy consumed in the network is evaluated and compared with traditional protocols (J-2).

1.5 Thesis Outline

The rest of this thesis is organized as follows: In Chapter 1, we present a background about wireless ad-hoc networks, their primary applications, as well as the design and research challenges that this type of networks faces. We also introduce the smart directional antenna technology, its applications, and most used array types. We finish the first chapter with a detailed description of the related work that has been done in the neighbor discovery, routing protocols and energy models for ad-hoc networks.

In Chapter 2, we investigate the impact of smart antennas on the connectivity of wireless ad-hoc networks by considering directional transmissions on the link probability model. We define the system model and we also state the assumptions considered at this stage of the thesis. We complete the chapter with an analysis of the results obtained.

Chapter 3 presents a gossip-based neighbor discovery algorithm that uses the information provided by directional antennas to discover neighbors in the second neighborhood of the node using directional beams. Then, a routing algorithm that aims to reduce the number of hops during the route construction using the information provided by the neighborhood discovery algorithm is also proposed in this article. We conclude this chapter with a comprehensive comparison between the scheme proposed in this article and similar solutions previously developed.

In Chapter 4, we present an energy model that considers the directionality of smart antennas. An extensive review of the models developed in this research topic introduces the chapter, then the assumptions made in our model are described as is the model itself. We conclude this chapter with a description of the simulations setup and an analysis of the obtained results.

Finally, we summarize this research work and present our conclusions and recommendations based on the analysis of the obtained results. We also provide some insights about the future directions that can be followed in this research line.

CHAPTER 2

LITERATURE REVIEW AND BACKGROUND

2.1 Introduction

In this chapter, we present the key concepts used in this thesis. The first section is dedicated to introducing the basic concepts of ad-hoc networks. Subjects as applications, design and research challenges, requirements and their impact on 5G communications are discussed in this section. Then, the smart antennas technologies are described. The benefits offered by this type of antennas, their fundamental concepts and possible impact in ad-hoc networks are presented in this section. We finalize this chapter by reviewing the state of the art in the research areas of routing protocols, neighbor discovery methods and energy consumption models of these type of wireless networks.

2.2 Ad-hoc Networks Basics

Wireless ad-hoc networks are data networks that are deployed without a fixed infrastructure or central controllers such as access points or base stations as schematized in Figure 2.1. In these networks, data packets are forwarded directly to the destination, if it is in the transmission range of the sender, or indirectly, through a multi-hop path of intermediary nodes that act as relays. This paradigm where a fixed infrastructure is not needed, is tolerant to topology changes and allows a fast deployment, is suitable for a large number of network implementations, such as mobile handheld devices, wireless sensors, disaster recovery networks, tactical networks and many others.

The versatility, low initial setup cost and ease of deployment allowed several manufacturers to enter into the ad-hoc networking field with different products and applications. Although they bring many advantages, ad-hoc networks face several issues particularly when the size of the network increases considerably, also known as scalability issues and when the velocity of the nodes increases from now on, mobility issues.

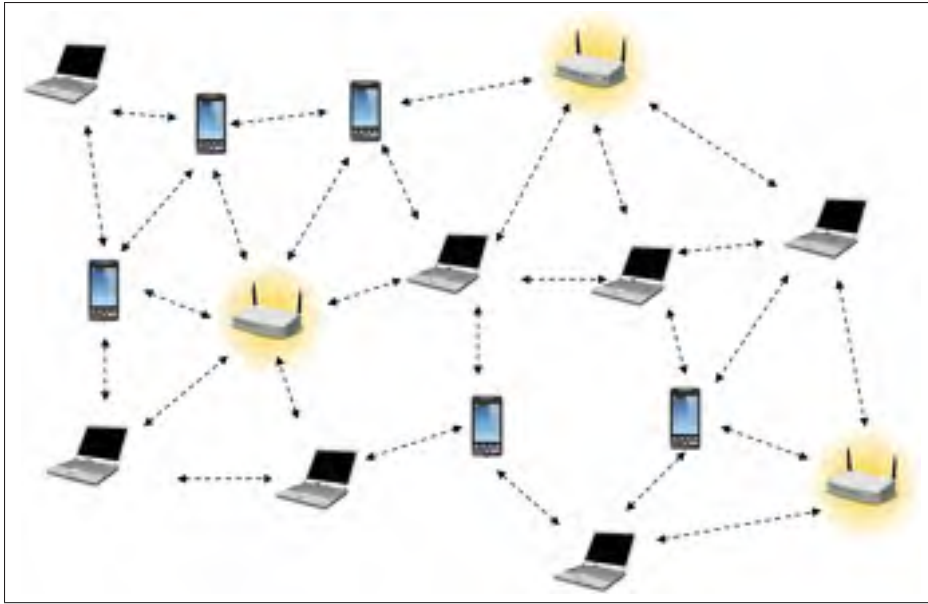

Figure 2.1 Mobile ad-hoc network topology
Taken from LifeNet Project (2011)

2.2.1 Applications of Ad-hoc Networks

Owing to its fast deployment, initial setup low cost and versatility, and many other attributes ad-hoc networks are suitable for several applications in the industry, research and commercial sectors such as military and tactical communications, emergency and disaster recovery networks, Wireless Sensor Networks (WSN), Wireless Mesh Networks (WMN), Opportunistic Networks and Device-to-device Communications . In this section, we first describe each application scenario and then we pointed out the key factors that make them suitable for ad-hoc networks:

- Military or Tactical Communications:** Usually, military operations are deployed on enemy's territories or inhospitable fields where is practically impossible to install a fixed infrastructure. Besides, these operations require a fast deployment, secure communication channels, and support for constant topology changes. As wireless ad-hoc networks do not require a fixed infrastructure or central controller, they can be deployed in very short time if compared to cellular networks, and they can also offer secured channels for peer

to peer communications. For these reasons, ad-hoc networks are considered as one of the most suitable solutions for military applications as well as tactical communications for civil defense or firefighting corps;

- **Emergency and Disaster Recovery Networks:** Natural disasters such as earthquakes or hurricanes can devastate extended populated zones and leave many people without telecommunications services. In this situations, it is critical to restore the communication services as soon as possible as well as to support tactical communications between rescue services, humanitarian organizations and government institutions. With ad-hoc networks, this services can be reestablished in hours instead of weeks, which would be the case if using wired or cellular networks. The multi-hop paradigm can also extend the coverage area as well as overcome the line of sight (LOS) issue which can be a turning point in geographic zones with a geographical singularity;
- **Wireless Sensor Networks:** Wireless Sensor Networks are a collection of sensors deployed in a specific geographical area that is connected wirelessly. The nodes are usually tiny devices that gather information about physical conditions around the sensors, then process the data and transport it to one or more gateways that are connected to the Internet. As the nodes are supposed to sense a parameter in a specific region, they usually do not move, so mobility is not considered. Besides, these nodes are placed in areas which are difficult to access or where it is not possible to connect to the public electric grid, so they are commonly battery powered. As batteries have a limited lifetime, it is important to develop protocols that are energy efficient and consider power constraints in their designs. Finally, the size of the network is usually larger than another type of ad-hoc networks;
- **Wireless Mesh Networks:** Wireless mesh networks (WMNs) are intended to provide broadband Internet access to mobile or fixed users as an alternative to cellular or wired networks, as illustrated in Figure 2.2. There are several advantages of WMNs such as the unnecessary of frequency reuse, the redundancy of the paths between the source and destination nodes, and higher bandwidths. Moreover, the use of unlicensed frequency bands and the installation of routers on rooftops or posts reduce the cost of deployment and operation;



Figure 2.2 Community mesh network topology
Taken from Conti, M. (2014)

- Opportunistic Networks** The opportunistic approach is the most recent evolution of the multi-hop paradigm as illustrated in Figure 2.3. Contrary to mobile ad-hoc networks (MANETs), opportunistic networks consider mobility as an opportunity to exploit instead of a problem. Actually, opportunistic networks assume that nodes can physically carry on buffered data until they find a next and valid hop to the destination. This means that the data can be delivered taking advantage of the mobility of the nodes even if there is never an active route between source and destination. This very new approach offers three main research opportunities. Mobility of nodes: it is important to understand human behavior to better model the mobility of the nodes and it is also important to be applied to real scenarios. Routing: considering the uncertainty of the future connectivity, the characteristic of human or vehicular mobility and the heterogeneity of node resources. Finally, data dissemination: this represents a concrete application scenario in which nodes usually play one of two roles: publisher or subscriber;

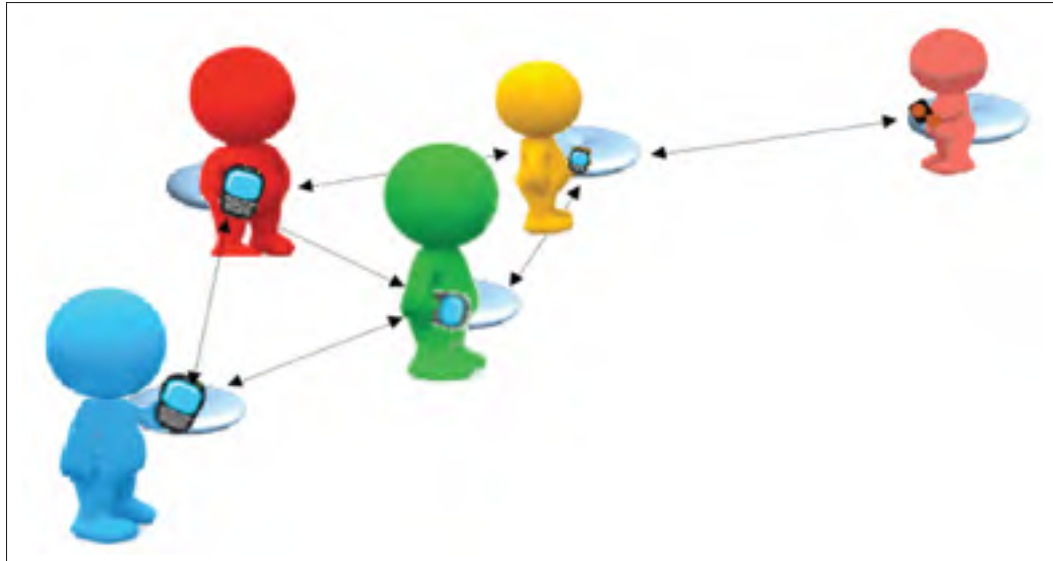

Figure 2.3 Opportunistic ad-hoc network
Taken from Conti, M. (2014)

- Ad-hoc applications in 5G: D2D communication** The next paradigm in wireless communications widely known as fifth generation (5G), aims at providing the end users with ubiquitous connectivity worldwide despite the technology used (cellular/wireless/FSO). While the conventional cellular architecture consists of connections from base stations to user equipment, 5G systems may rely upon a two-tier architecture consisting of a macro cell tier for base station to device communication, and a second device tier for device to device (D2D) communications. Such architectures are a hybrid of conventional cellular and ad hoc networks. Thus, integration of MANET with cellular architectures solves the coverage and connectivity problem providing a reliable ubiquitous connection (see Figure 2.4). The future is promissory for ad-hoc communications but lessons have to be learned from the past and real scenarios, as well as specific applications instead of general approaches, must be considered in order to attract the interest of the industry and network operators.

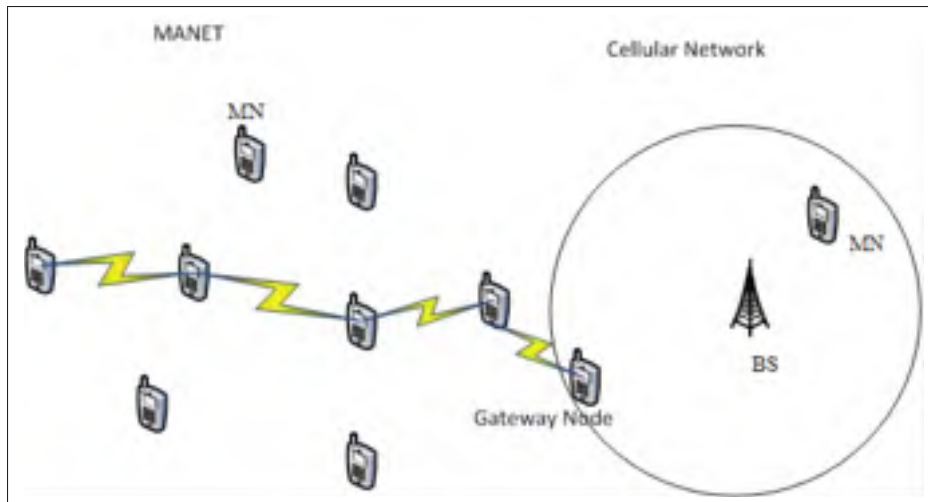

Figure 2.4 Device to Device Communications in 5G
Taken from Conti, M. (2014)

2.2.2 Design and Research Challenges

In this section, we present the main challenges that face the scientific community and the industry regarding of design and open research issues. Although during the past two decades a lot of work has been done in this area there are still several issues that need to be addressed and some others that have emerged as a consequence of the evolution of the wireless technology:

- Security Issues and Challenges:** To have secure communications among mobile nodes is a priority issue. During years security has been an active research theme. MANETs present several new challenges for researchers and developers like open network architecture, shared wireless medium and highly dynamic network topology. Nevertheless, the existing security measures do not cover MANETs and it is necessary the implementation of news security solutions. The routing protocols for wireless ad-hoc networks should be able to solve all these issues efficiently;
- Bandwidth constraint:** The broadcast condition is inherent to ad-hoc networks. Therefore, the available bandwidth per wireless link depends on the number of nodes and the traffic they handle. Thus, only a fraction of the total bandwidth is effectively available for

transmission and reception in every node. On the other hand, mobility of the nodes makes established routes to broke thus route reparation procedures have to run, these procedures also consume part of the available bandwidth so they should be carefully designed to reduce the impact on the effective bandwidth available;

- **Location-dependent contention:** The contention for wireless channel increases as the number of nodes increases. The high contention implies a high number of collisions and subsequent bandwidth wastage. A routing protocol for wireless ad-hoc networks should have mechanisms to distribute the network load uniformly across the network;
- **Other challenges:** Computing power, battery power, and buffer size also limit the capability of a routing protocol for ad-hoc networks.

2.2.3 Requirements

As many other aspects of wireless networks and especially for mobile ad-hoc networks, routing has several requirements that need to be meet in order to assure the optimal operation of the network. These requirements are related to delay, route reparation, scalability, and others detailed as follows:

- **Minimum route acquisition delay** The time required for a node to obtain a route to a node that has not previously sent a packet should be as minimal as possible. This delay is dependent on the size of the network and the path length;
- **Quick route reconfiguration** The topology of MANETs changes suddenly due to the mobility of the nodes. As established paths can be broken, routing protocols must be able to find alternate paths or repair broken paths as quickly as possible;
- **Loop-free routing:** Due to the frequent changes in topology, transient loops may form in the previously established route. A routing protocol for ad-hoc networks should efficiently detect such transient loops and take corrective actions;

- **Scalability:** Scalability refers to the ability of a routing protocol to perform efficiently even when the size of the network increases. To meet this requirement, the protocol will require to minimize the routing overhead and adapt to the network size. In the literature reviewed, we observed that a hierarchical approach is usually used to meet this requirement;
- **Provisioning of Quality of Service:** In a network, quality of a service (QoS) is determined by the guaranteed data transfer in a given period. The QoS also depends on the node density of the network. If the density is large then it's difficult to transmit information from the source to remote destination, because the overhead in transmitting information through a large number of intermediate devices disturb the quality of service of the network. Furthermore, the constant change in network topology and limitation of network resources makes the quality of service in ad-hoc networks a challenging task;
- **Security and privacy:** Routing protocols for wireless ad-hoc networks must have inbuilt capabilities to avoid resource consumption, denial-of-service, man-in-the-middle, and similar attacks against the network;
- **Localization Determination:** Localization is an important issue in ad-hoc networks. It is required for clustering, topology control, and routing, but it is not always possible to obtain it from a GPS device (sometimes sharing the precise position of a node could be considered unsafe too). In fact, when using this technology nodes are exposed to be easily located because the algorithm used by GPS location is widely known;
- **Energy Consumption:** In some ad-hoc implementations, the nodes are mobile and powered by batteries. Therefore, it is important to preserve energy to keep the nodes active as much as possible. The limited battery capacities of these mobile hosts have attracted a lot of attention from the research community toward the significance of power awareness in wireless ad-hoc networks design. Due to the complicated nature of ad-hoc networks, all the participating nodes must have a small and light weighted and designing of power-efficient systems is a challenging factor in ad-hoc networks.

2.3 Smart antennas technologies

2.3.1 Introduction

Smart antennas are most often realized with either switched-beam or fully adaptive array of antennas. An array consists of two or more antennas (the elements of the array) spatially arranged and electrically interconnected to produce a directional radiation pattern. In a phased array the phases of the exciting currents in each element antenna of the array are adjusted to change the pattern of the array, typically to scan a pattern maximum or null in the desired direction. Although the amplitudes of the currents can also be varied, the phase adjustment is responsible for beam steering. Smart antennas have the potential to increase the performance of wireless networks in general, but especially in ad-hoc networks as they can provide extended range coverage, better spatial reuse, lower energy consumption and increase system capacity. In this section, we present a brief description of the benefits that this technology has to offer to ad-hoc networks, followed by a discussion of the foundation of smart antennas.

2.3.2 Benefits of Smart Antenna Technologies

Enhanced coverage

Smart antennas can provide a better coverage due to range extension and deeper obstacle penetration. Preserving the same power level at the transmitter or receiver and just varying the antenna gain at transmitting node the communication range can be increased. As shown in Eq. 2.1, the power at receiving node is given by:

$$P_r = P_t + G_r + G_t - PL \quad (2.1)$$

Taken from Rappaport and Liberti (1999)

Where P_r and G_r are the power received and the gain at receiving node respectively; P_t and G_t are the power transmitted and the gain at transmitting node and PL is the path loss between both nodes. For a successful communication, a specific P_{rmin} at reception node, commonly named threshold (γ) is required. If the gain is increased on any or both of the sides of the communication, the link can tolerate a higher PL as shown in:

$$PL(d) = \overline{PL}(d_0) + 10n \log \left(\frac{d}{d_0} \right) + X_\sigma \quad (2.2)$$

Taken from Rappaport and Liberti (1999)

Consequently, a higher tolerance in the PL translates in an extension of the communication range. Considering that smart antennas can offer a higher gain than omnidirectional antennas, smart antenna arrays can offer an extension of the communication range.

Lower deployment costs

As consequence of the range extension described in the previous section, fewer nodes are required to cover a given area when smart antennas are used. Therefore, the initial deployment cost of such network can be reduced. Nonetheless, the cost of smart antennas should be considered. They are currently more expensive than traditional antennas, although new technologies are reducing the production costs so in the near future this will be not an issue as stated by Roy et al. (2006).

Link quality

Link quality can be improved through multipath management with directional antennas. It is widely known that the multipath effect can result in fading or time dispersion but smart antennas can help to mitigate the impact of this effect or, even better, exploit the diversity inherent in multipath.

Improved system capacity

Smart antennas can allow nodes in MANETs to operate at the same range as with omnidirectional antennas but using less power. This in turns enables TDMA and FDMA systems to reuse frequencies more often than systems with omnidirectional antennas, because the carrier to interference ratio is greater when smart antenna systems are used. In other words, this increases the number of users that can share the medium. Besides, smart antennas also allow separate users spatially if using Spatial Division Multiple Access (SDMA). Since this approach allows to allocate more users with a limited spectrum allocation, SDMA can lead to improved capacity compared with conventional antennas.

2.3.3 Foundation of smart antenna technology

The term smart antenna typically refers to an array of low gain antennas connected to a sophisticated signal processor (SP). This SP adapts the resulting beam to empathize signals of interest or nulling interfering signals as shown in Figure 2.5. To simplify the analysis of antenna arrays, we adopt the following assumptions(taken from Rappaport and Liberti (1999)):

- The space between the elements is small enough that there is no amplitude variation between the signals received at each element;
- There is no mutual coupling between elements;
- All incident fields can be decomposed into a discrete number of planes waves. In other words, there are a finite number of signals;
- The bandwidth of the signal incident on the array is small compared with the carrier frequency.

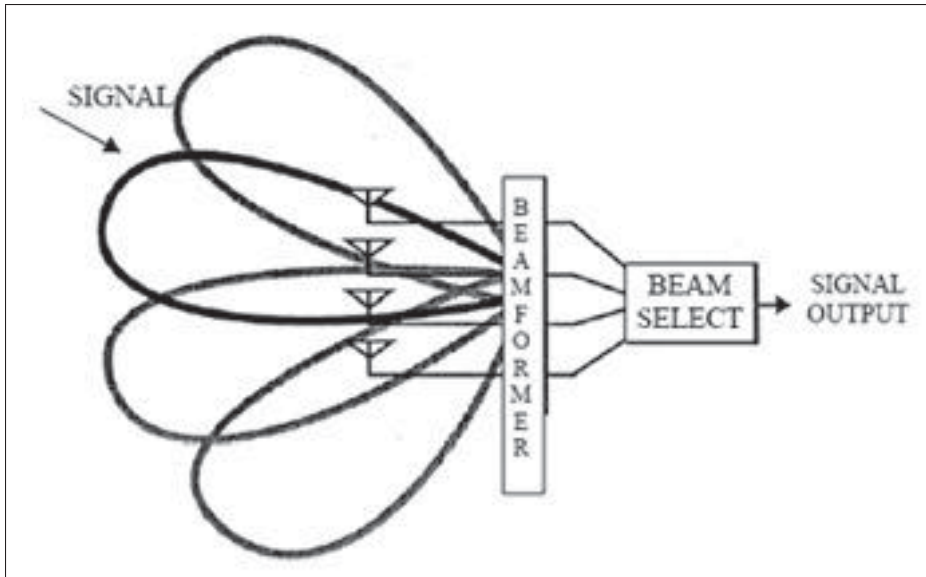

Figure 2.5 Smart directional antenna schematic
Adapted from Gross (2005, p. 66)

Linear Array

The Linear array is the simplest possible geometry array, where all elements are aligned along a straight line and have a uniform spacing between elements. Figure 2.6 depicts the minimum array possible which is the 2-element array. This array is a good starting point to understand the phase relationship between adjacent antenna elements.

Figure 2.6 shows two vertically polarized dipoles separated a distance L . The field point is located at a distance r from the origin such that $r \gg L$. We can, therefore assume that r, r_1 and r_2 are approximately parallel to each other, so the following approximations are true:

$$r_1 \approx r + \frac{L}{2} \sin \theta \quad (2.3)$$

$$r_2 \approx r - \frac{L}{2} \sin \theta \quad (2.4)$$

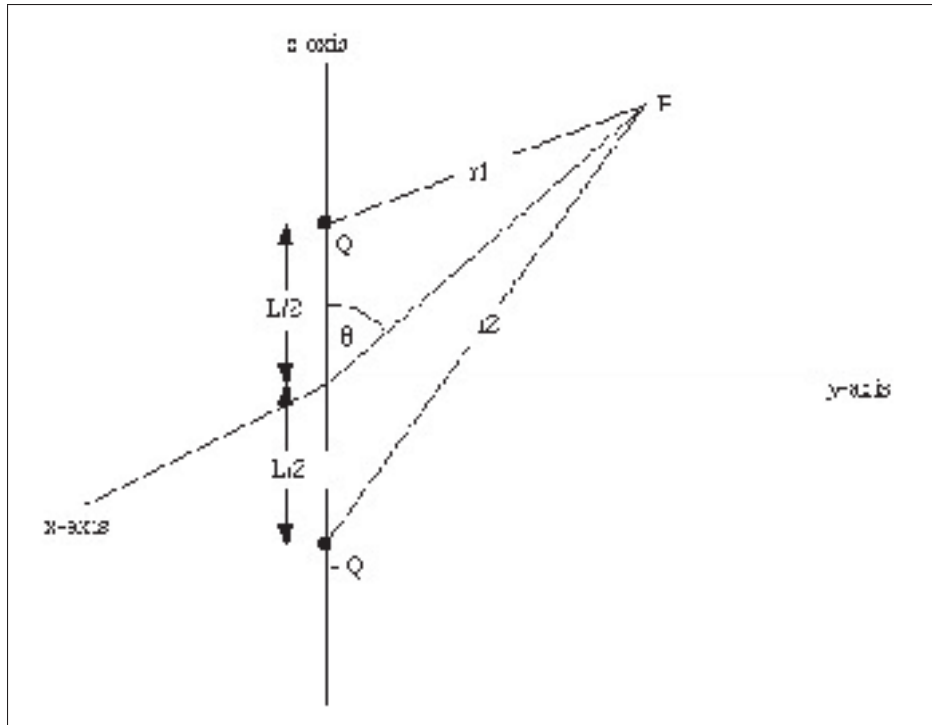

Figure 2.6 Two infinitesimal dipoles
Adapted from Gross (2005, p. 68)

Then, assuming that $r_1 \approx r_2 \approx r$ and using superposition we can now find the total electric field as follows:

$$E_{\theta} = \frac{jk\eta I_0 L e^{-jkr}}{4\pi r} \sin \theta \cdot \left(2 \cos \left(\frac{kd \sin \theta + \delta}{2} \right) \right) \quad (2.5)$$

Where δ = electrical phase difference between the two elements, L = dipole length, θ = as measured from the z axis and d = element spacing.

Circular arrays

Same as for linear arrays, circular arrays can be used to increase gain and for beamsteering. Figure 2.7 shows a circular array of N elements placed on the $x - y$ plane with a radius equal to a .

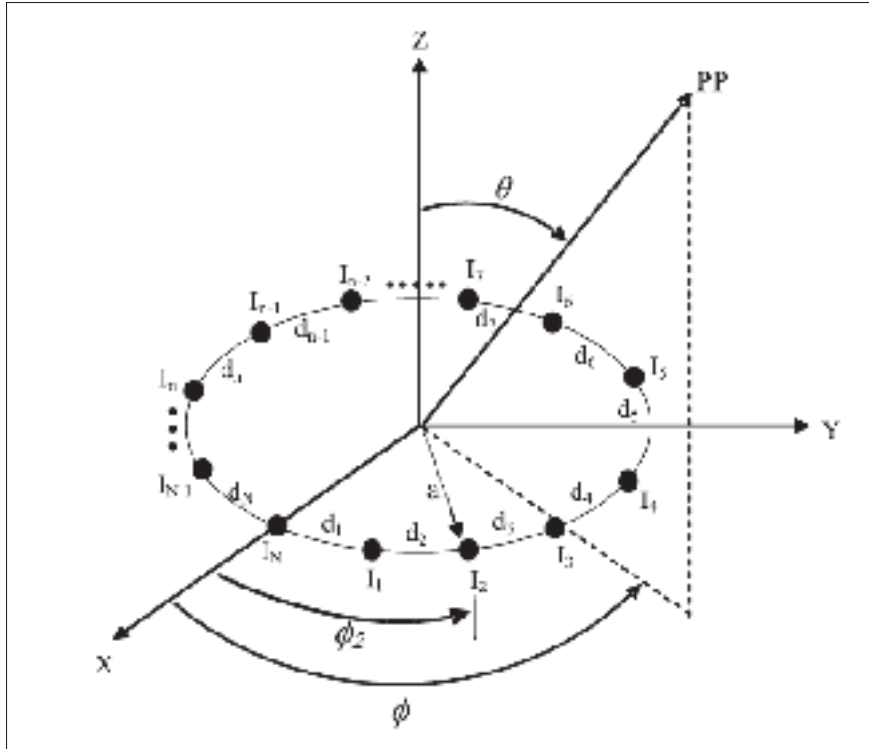

Figure 2.7 Circular array of N elements
Adapted from Gopi Ram (2015)

The n th array element is at a distance a from the origin with angle ϕ_n . It is also possible to associate a weight w_n and phase δ_n to each element. As before we assume far field conditions and that the point of observation is such that the position vectors are parallel or $r_1 \approx r_2 \approx r$.

The array factor can now be found in a similar fashion as was done with the linear array, as follows:

$$AF = \sum_{n=1}^N w_n e^{-j[k a \sin \theta \cos(\phi - \phi_n) + \delta_n]} \quad (2.6)$$

where

$$\phi_n = \frac{2\pi}{N}(n-1) = \text{angular location of each element} \quad (2.7)$$

Beamsteered circular arrays

The beamsteered circular array uses the same principle as linear beamsteered arrays but in this array, we beamsteer the array to the angles (θ_0, ϕ_0) . Therefore, the array factor is rewritten as:

$$AF = \sum_{n=1}^N w_n e^{-j\{ka[\sin\theta\cos(\phi-\phi_n)-\sin\theta_0\cos(\phi-\phi_0)]\}} \quad (2.8)$$

As an example, let us assume that all weights are uniform, and the array is steered to the angles $\theta_0 = 20^\circ$ and $\phi_0 = 0^\circ$. With $N=10$ and $a = \lambda$, we can plot the beamsteered circular array pattern in 2-D as illustrated in Figure 2.8.

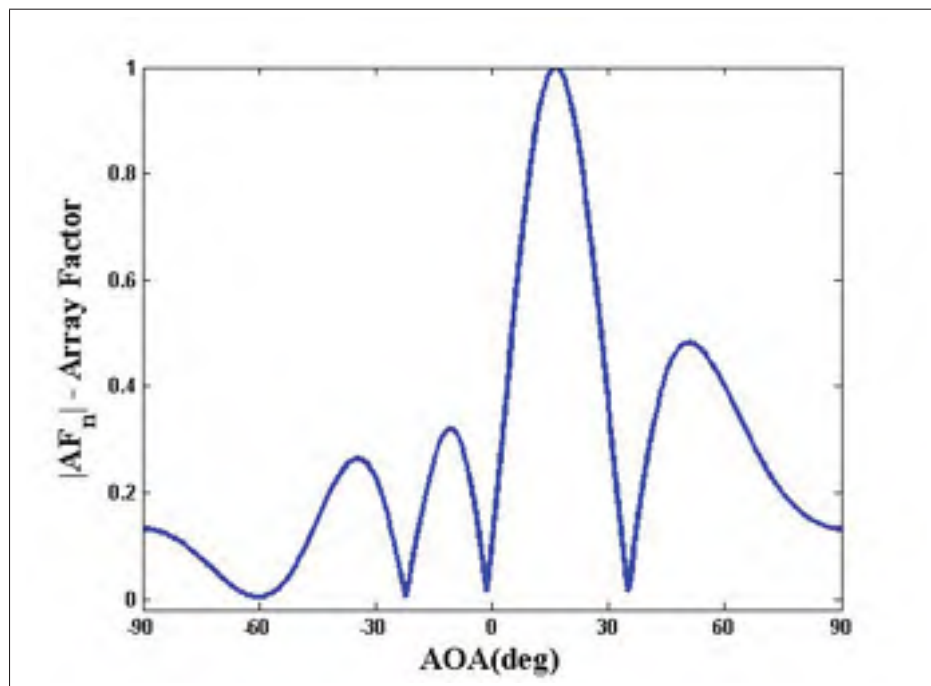

Figure 2.8 AF elevation pattern for beamsteered circular array ($\theta_0 = 20^\circ$, $\phi_0 = 0^\circ$)
Taken from Raviteja (2016)

Adaptive beamforming

Adaptive beamforming refers to antennas that control their beam patterns through algorithms based on certain criteria. These criteria can be steering towards a specific direction, nulling interfering signals, adapt the beamwidth, maximizing the signal-to-interference ratio (SIR), minimizing the mean-square error (MSE), between others. To control the beams, the antenna system can use analog devices, but it is generally performed by using digital signal processors (DSP). Adaptive beamforming is usually the most efficient solution because it adapts the array pattern dynamically using an algorithm according to the changing electromagnetic environment.

In adaptive beamforming, as depicted in Figure 2.9, the weight vector $w_{k,i}$ is adjusted or adapted, to maximize the quality of the signal that is available to the demodulator for signal k at time index i (Rappaport and Liberti (1999)).

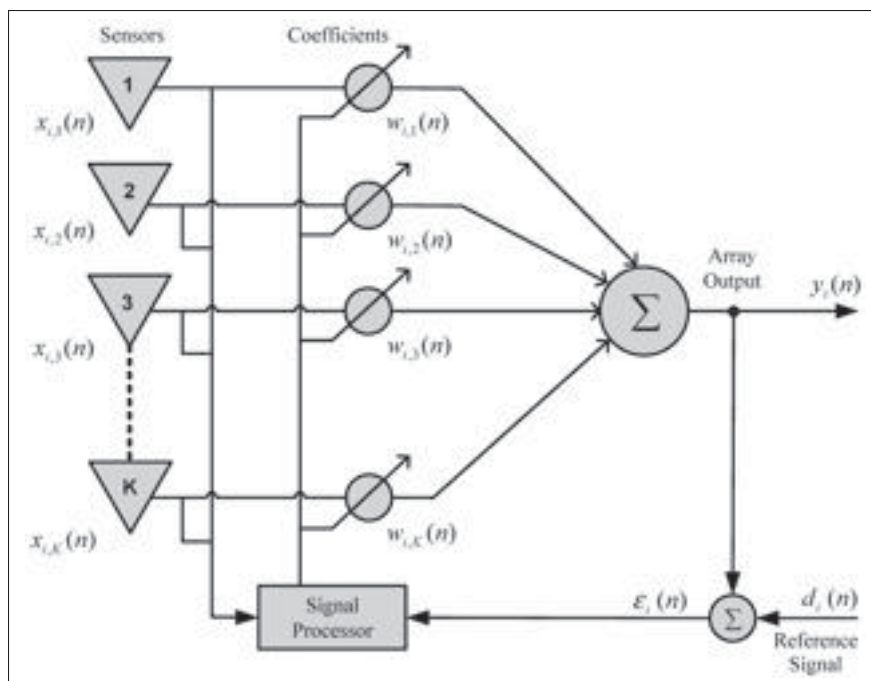

Figure 2.9 An adaptive array structure
Taken from Almeida (2015)

2.4 Literature Review

In this section, we summarize the most relevant research activities performed in the modeling of ad-hoc networks using graph theory, recent advances in neighbor discovery and routing algorithms using omnidirectional and directional antennas. We finish this section by reviewing the state of the art of energy models for ad-hoc networks with omnidirectional and directional antennas.

2.4.1 Modeling ad-hoc networks

In the past decade, wireless ad-hoc networks have attracted a lot of attention from the international research community. Extensive studies such as Gupta et al. (2008) and Zemlianov and de Veciana (2005) have been performed to measure and improve the capacity and scalability of these networks while others tried to adapt the existing MAC protocols to the changing conditions of ad-hoc networks(Chen and Jiang (2007)).

Another aspect widely studied is the development and implementation of efficient routing protocols (Royer and Toh (1999), Maker and Chakeres (2000)) and more recently the implications of nodes with selfish behaviors in the overall performance of the wireless network (Marbach (2008)). Due to the absence of commercial solutions and the complexity of the ad-hoc scenarios, simulations have emerged as a widely accepted method to evaluate ad-hoc networks. However, simulation models can not always provide a thorough understanding of the relationship between network performance and specific parameters such as hop count, connectivity or energy consumption. For this reason, many recent research efforts have considered the use of mathematical models to describe the connectivity properties of wireless ad-hoc networks better.

In literature, many researchers have proposed geometric random graphs as a mathematical model to describe the connectivity properties of wireless ad-hoc networks better. The first attempt to do so was proposed by Piret (1991) where the connectivity of two-dimensional radio networks as a function of the range of the transmitters was addressed. This article's results

shown that there is a critical range R that guarantees the connectivity of the network where R is directly proportional to L (longitude of the square area) and D (node density). Later, Gupta and Kumar (1998) developed another fundamental research on the minimum power required to obtain a fully connected network. The authors found a relationship between the minimum power required and the number of nodes (n) where n goes to infinity.

Another study performed by Bettstetter (2002) derived in an analytical expression that defines the required radio r_0 in a network with density ρ that almost assures that k nodes in the network are connected (k – connected). For this purpose, a random placement of the nodes on the evaluated area and a simple propagation model was assumed.

All the models mentioned above used the simple path loss propagation model in their assumptions. This means that the coverage area of each node is assumed as a perfect circular shaped area around the node with radius R . Here, R is the distance where the received power is equal to the receiver's sensitivity γ as it is illustrated in Figure 2.10. Although this assumption is very common, it is not realistic because it does not consider the randomness of the wireless channel. This premise also assumes that the probability to have a link between any pair of nodes (i,j) or the link probability ($p(r_{ij})$) is a simple step function as shown in Equation 2.9.

Later, Németh and Vattay (2003) pointed out that it is not accurate to model a wireless ad-hoc network as a simple random graph because the link probability depends on the geometric distance between the nodes. One of the consequences of this dependency is that the link probability between two nodes increases when they have a common neighbor. This type of graphs with a link dependency on the distance between nodes is referred in the literature as geometric random graphs.

In an attempt towards a better modeling of wireless ad-hoc networks, recent studies like Bettstetter (2004); Bettstetter and Hartmann (2005) proposed to consider the log-normal radio model into the geometric random graph. This model is more realistic and suitable for ad-hoc networks as it considers the medium scale radio signal power variations. However, all these previous works considered omnidirectional transmissions on both sides of the ongoing communication.

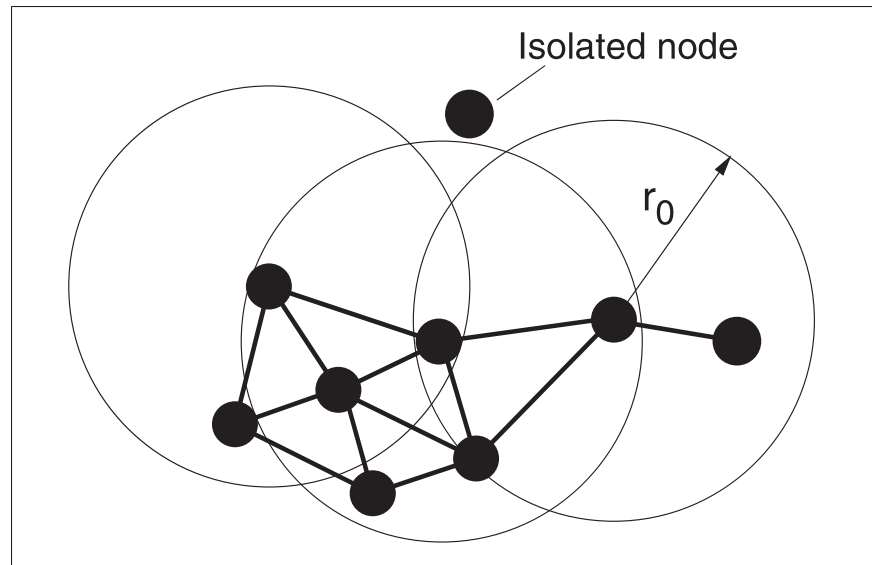

Figure 2.10 Graph representation with omnidirectional antennas
Taken from Bettstetter (2002)

This research work is a contribution to the mathematical modeling of wireless ad-hoc networks because it takes into account the gain and directivity of the directional antennas and analyses their impact on the link probability and connectivity of the wireless ad-hoc network when they are modeled as a geometric random graph.

$$p(r_{ij}) = \begin{cases} 1 & 0 < r_{ij} \leq 1 \\ 0 & r_{ij} > 1 \end{cases} \quad (2.9)$$

Taken from Hekmat(2006, p. 30)

2.4.2 Neighborhood Discovery

One of the distinctiveness of MANETs is their self-configuring capability, which means that the network does not need a centralized unit to perform the tasks required to keep the network functioning. Neighborhood discovery is one of the self-configuring tasks that is performed once nodes are deployed, and it allows each node to discover its surrounding neighbors. This

information is then used by the upper layer protocols such as topology control, medium access control and routing protocol to perform their own tasks.

In recent years, a significant amount of research has been done in this area. For example, Vasudevan et al. (2005); McGlynn and Borbash (2001); Keshavarzian et al. (2004); An and Hekmat (2007) considered the type of antenna used. We gather from these articles that there are two types of neighbor discovery algorithms depending on which antenna type is used: omnidirectional and directional neighbor discovery. The authors in McGlynn and Borbash (2001); Keshavarzian et al. (2004) presented two algorithms for neighbor discovery in wireless ad-hoc networks where nodes have omnidirectional antennas. While the algorithm proposed in McGlynn and Borbash (2001) can operate in asynchronous mode, synchronization is a requirement for the algorithm described in Keshavarzian et al. (2004).

Previous research also proposed neighbor discovery algorithms using directional antennas. In Vasudevan et al. (2005), the authors developed several algorithms considering three approaches: directional transmission and omnidirectional reception (DO); directional transmission and reception (DD); and omnidirectional transmission and directional reception (OD). Each of these three strategies was first evaluated considering a direct discovery algorithm, which means that a node discovers its neighbors only when it successfully hears a transmission from that neighbor. Then, the strategies mentioned before were evaluated considering a gossip-based discovery algorithm where nodes gossip about each other's location information to speed up the discovery process. The gossip-based algorithm allows a node to discover its neighbors indirectly and also allows a node to discover multiple neighbors in the same step. The results of this work showed that those differences help nodes to discover their neighbors significantly faster than using a non-gossip discovery algorithm.

The main drawback to gossip-based algorithms proposed so far is that they assume that each node obtains its location information using a GPS device and if the number of nodes equipped with GPS is reduced, the performance of the discovery algorithm also degrades correspondingly. In An and Hekmat (2007) the authors introduced an original neighbor discovery algo-

rithm with directional antennas counting the mobility of the nodes and improving the energy consumption. For the first problem, the cycle of the neighbor discovery is self-adapted according to the dynamics of the network. Furthermore, to improve the power efficiency and reduce overhead, the protocol can limit neighbor discovery attempts in regions where no new neighbors are likely to be found. This work did not take into consideration multi-hop system and only discovers one-hop neighbors.

Latterly, Zhang and Li (2008) proposed 2-way random neighbor discovery algorithms based on the algorithms previously proposed by Vasudevan et al. (2005). Four algorithms were proposed; two of them using omnidirectional antennas in certain stages of the algorithm and the other two using directional antennas all the time. This work is limited because it does not consider the gossip-based approach and for synchronization purposes, it requires the nodes to have GPS devices.

Finally, in Ramanathan et al. (2005), the authors proposed several neighbor discovery methods (NB) based on the usage of the directional antenna to transmit or receive data. According to this paper, there are three kinds of NB methods: N-BF (without beamforming), T-BF (using beamforming only on transmission) and TR-BF (using beamforming on transmission and reception). Through simulations, the authors concluded that the use of beamforming on both, transmission and reception offers a higher throughput due to the higher bandwidth available when using directional antennas but it also increases the packet loss due to the synchronization required in order to point both antennas on the same direction at the same time. However, the solution where directional antennas are used for transmission and omnidirectional antennas are used at reception offers a better-balanced performance. This is true because there is a reduction in the total throughput of the network, but it is compensated with an improvement in the packet loss ratio because a pointing mechanism is not needed when the omnidirectional antennas are used for reception. Based on these results, we have also assumed an omnidirectional or directional beamforming for transmissions and only omnidirectional beamforming at reception.

2.4.3 Routing Algorithms

Since the first development of routing protocol for mobile ad-hoc networks, researchers have shown their interest to support the routing decision based on the position of a node to increase the packet delivery ratio and reduce the end-to-end delay. In the literature, there are several implementations of both reactive and proactive routing protocols. In Ko and Vaidya (2000) the authors proposed a reactive routing protocol called Location Aided Routing (LAR) that uses the position information obtained by a GPS device to bound the search of a route to the defined request zone. This zone is defined by the expected location of the destination node at the time of the route discovery. Simulation results indicated that using location information resulted in significantly lower routing overhead, as compared to other algorithms that do not use location information. However, drawbacks of this approach are the need for GPS and the reactive nature of the protocol which increases the setup delay of a route.

Basagni et al. (1998) proposed a proactive protocol where the nodes need the position information from a GPS to calculate the route to destination. The entire network was divided into hierarchical zones within which the information about the position of the nodes is distributed. As in Ko and Vaidya (2000), this solution also depends on the GPS devices, besides the mobility of the nodes between zones creates an unnecessary overload. In Quintero et al. (2007) the authors developed Location-Enhanced On-Demand (LEOD) routing protocol, a framework that uses the information provided by smart antennas to determine the position of the nodes in the network and using this information, discover and maintain routes. The positioning algorithm only considered one-hop neighbors and the method used to estimate the position is based on the angle of arrival technique.

Studies of Dai and Zhao (2015) investigated the trade-off between directional and omnidirectional antennas in terms of throughput improvement and end-to-end delay reduction. In particular, the article investigated the effective transmission range of directional antennas and the scaling rules of the delay due to the multi-hop routes in networks with only directional antennas (DIR). Although the article demonstrated that there is a reduction in the end-to-end

delay, these results were expressed in an asymptotic notation giving only a general overview of the network performance as a function of the number of nodes. It only considered static nodes and the routing strategy is quite simple, choosing the next hop with the shortest distance to forwards a packet. In another recent paper, Chen et al. (2013) analyzed the achievable throughput of MANETs when each node is equipped with directional antennas and a general two-hop relay algorithm is adopted as routing scheme. The main contribution of this paper was the development of a theoretical closed-form model to analyze the achievable throughput for any specific antenna beamwidth θ and the optimal value of θ required to achieve the optimal throughput.

Cobo et al. (2015) introduced a novel Location Based Routing Algorithm (LBRA) protocol, that utilizes smart antennas to estimate node's positions in the area covered by the network. The proposed protocol takes routing decisions based on neighbor's relative positions. Besides, it uses the information about the battery charge remaining in the nodes to make power-aware routing decisions. Although the results showed that LBRA outperforms the Ad-hoc On-demand Distance Vector (AODV) Perkins et al. (2003) protocol in terms of reducing the routing overhead and incrementing the packet delivery rate, there is no evidence that the throughput and end-to-end delay performed better than previous solutions. Additionally, the impact of the mobility of the nodes was not addressed in this article.

Another article (Cheng et al. (2010)), proposed the Mobile Orthogonal Rendezvous Routing Protocol (MORRP) which uses directional antennas to assist routing in highly mobile environments. In this article, the concept of Directional Routing Table (DRT) was introduced. MORRP maintains a list of next hop based on probabilities to each interface direction which performs well when the path lengths are short. For longer routes, it relies on route request (RREQ) packets as in the traditional reactive routing protocols. Although MORRP seems to perform better than traditional routing protocols, it has been only evaluated in square topologies and the extended range of the directional beams was not exploited.

Many research efforts have demonstrated that the use of directional antennas for routing in MANETs can improve the throughput and end-to-end delay of the wireless network. For example, an experimental study in Ramanathan (2001) presented an improvement of up to 118% in the average throughput, when directional antennas are used. Later, in Yi et al. (2003, 2007) an analytical model demonstrated that is possible to obtain a throughput improvement in the order of $2\pi/\sqrt{\alpha\beta}$ in purely random networks and $\pi^2/\alpha\beta$ in arbitrary networks where α and β are the antenna beamwidth for transmission and reception correspondingly. More recently, Li et al. (2011) established an upper bound of $\Theta(\sqrt{\log n}/n)$ and a lower bound of $\Omega(1/\sqrt{n \log n})$ on the maximum throughput that can be achieved in random networks with multi-hop relay schemes.

Moreover, the delay as function of the number of the nodes in the network have been studied in Dai et al. (2005) where a single channel model considering the path loss effect was used. According to the authors, the delay $D(n)$ is scales with $\Theta(\sqrt{n/\log n})$. Later in Dai and Zhao (2015), a more comprehensive scenario is evaluated considering the large scale path loss and the shadow fading effect as well as omnidirectional and directional antennas. The results of this work have shown that the delay is reduced by a factor of $(4/\tan^2(\theta/2))^{-2/\alpha}$ when directional antennas are used in the network, where θ is the beam angle of the directional antenna. Although the order sense function can help us to understand the impact of the growing number of nodes the in network, it does not explain the actual achievable throughput and the end-to-end reduction that can be achieved when directional antennas are used in the mobile ad-hoc network. Besides, to the best of our knowledge, the reduction in the number of hops between source and destination nodes due to the use of narrow beams and the position of the nodes located in the second neighborhood of a node has not been previously investigated.

2.4.4 Energy Models

Wireless ad-hoc network are usually powered by batteries that have a limited life time. For this reason, power efficiency is a critical issue in this type of networks. Energy issues have been an active research topic since the first apparition of wireless ad-hoc networks. Most of the

previous work is focused on developing medium access control protocols to be energy efficient in ad-hoc networks. For example, Singh and Raghavendra (1998) developed an extension of the original MACA protocol with the addition of a separate signaling channel. The novelty of the protocols is the conservation of power by turning off those nodes that are not actively transmitting or receiving packets. Through simulations, the authors demonstrated that PAMAS (Power Aware Medium Access Scheme) saves between 10 to 70% of power in fully connected networks where the number of nodes is between 10 to 20. The proposed protocol does not affect the delay and throughput performance of the traditional protocol.

In another article, Kranakis et al. (2005) explored the differences in power consumption of ad-hoc networks when directional or omnidirectional antennas are used to connect at least k -nodes. The proposed model assumed a random positioning of the nodes in a square area of a unit length segment. Through simulations the authors proved that the energy consumption required to maintain k -connectivity of the resulting network is lower when using directional antennas instead of using omnidirectional antennas.

Spyropoulos and Raghavendra (2002) presented an energy-efficient routing and scheduling algorithm to coordinate transmissions in ad-hoc networks. This study considered single beam directional antennas installed in the nodes and implements the proposed solution in three steps. First, the shortest path with minimum energy consumption are calculated. Then the maximum amount of traffic that can be transported is estimated and finally the transmissions are scheduled trying to minimize the time of connection between transmitter and receiver. The problem was formulated using graph theory and through simulations, the authors have demonstrated that the proposed routing scheme is more efficient than traditional protocols in terms of energy cost for routing.

Later, Dai et al. (2005) proposed four algorithms for routing tree construction that take advantage of directional antennas. An important contribution of this paper is the assumption that antennas have an adjustable beam angle. It also allows the nodes to control the irradiated power so it can be increased to reach farthest nodes. The simulation results showed that when

the nodes are relatively sparse and the beam angle is small, the linear insertion (LI) algorithm outperforms the others.

More recently, Zhu et al. (2006) developed an energy consumption model for common MAC Protocols (CSMA, MACA and 802.11) that takes into account energy consumption due to packet transmissions as well as control packets and retransmissions. The authors verified by simulations that the proposed model match the actual energy consumption much better than the existing models. The results of this paper also showed that the proposed energy model could be used to determine paths with minimum energy cost and thus achieving better energy conservation performance than other models.

Finally, in Zhu and Wang (2011) the authors investigated the energy consumed by routing over MANETs. They remarked that without a careful design, some energy-efficient routing algorithms can perform worse than traditional routing protocols. Although the proposed scheme (PEER) demonstrated that it improves the performance during path discovery and it also used several mobile scenarios, it assumed the use of omnidirectional antennas only. We consider that it will be interesting to derive an extension of the link cost model proposed by these authors to include the directionality of smart antennas in ad-hoc networks.

CHAPTER 3

MODELING DIRECTIONALITY IN WIRELESS AD-HOC NETWORKS

3.1 Introduction

Wireless ad-hoc networks are deployed without a fixed infrastructure or central controllers such as access points or base stations. In these networks, data packets are forwarded directly to the destination if they are within the transmission range of the sender or sent through a multi-hop path of intermediary nodes that act as relays. This paradigm, where a fixed infrastructure is not needed, is tolerant to topology changes and allows a fast deployment is suitable for a large number of network implementations, such as mobile hand-held devices, wireless sensors, disaster recovery networks, etc.

In recent years, smart directional antennas have been identified as a robust technology that can boost the performance of wireless ad-hoc networks in terms of coverage, connectivity, and capacity. Contrary to omnidirectional antennas which irradiate energy in all directions, directional antennas can focus the energy in a specific direction, extending the coverage range for the same irradiated power. Longer ranges provide shorter paths to destinations and improve connectivity. Moreover, directional antennas can reduce the collision probability in a contention-based access scheme as they can steer the main lobe in the desired direction and set nulls in all the others, thereby they minimize the co-channel interference and reduce the noise level. Connections are more reliable due to the increased link stability and spatial diversity. Shorter paths, as well as alternative paths, are also available as a consequence of the use of directional antennas. All these features combined results in a higher network capacity.

In this chapter, we investigate the impact of smart antennas in the connectivity of wireless ad-hoc networks. To take into consideration this property, we assume directional transmissions on the link probability function that is used to set the weight of the edges in the graph that represents the wireless ad-hoc network. The rest of the chapter is organized as follows: First, we introduce graph theory and its applications to multi-hop networks, then we describe the

system model assumptions made in our research and the proposed model, we continue with the simulations setup, and we finish the chapter with an analysis of the obtained results.

3.2 Graph theory and Ad-hoc Networks

The topologies of ad-hoc networks are constantly changing due to nodes' movements and radio signal variations. However, from the topology point of view a wireless ad-hoc network can be represented as a graph $G(V, E)$ where the nodes correspond to the vertices of the graph and the links between the nodes correspond to the edges of the graph.

To better understand the relationships that happens on graph representations of ad-hoc networks, it is necessary to define the following terms:

- The number of direct neighbors of a given node is defined as the degree of the node;
- A graph G is connected if at least exist a path $\{i...j\}$ between any pair of nodes i and j . When there is no path between any pair of nodes, the network is said to be disconnected;
- The hop count specifies the number of hops on a path between any pair of source-destination nodes;
- The average hop count is the mean value of the number of hops between all the possible source-destination pairs in the network.

3.3 System Model

In this section, we will describe the considerations made in our model. We begin with the node distribution model which is a description on how we have placed the nodes over the area to be analyzed, then we describe the antenna model, and we finalize this section with a description of the wireless channel model assumed in this research work.

3.3.1 Node Distribution Model

We consider that nodes are uniformly distributed over a square shaped service area of length M ; therefore, the coverage area is defined as $\Omega = M \times M$ and the node density is defined as $d = N/\Omega$ where N is the total number of nodes.

3.3.2 Network Topology

In real scenarios nodes are positioned on a three-dimensional space (x_i, y_i, z_i) . In order to simplify our analysis and following a commonly accepted assumption made in several previous works we have decided to use a two dimensional array (x_i, y_i) with N columns where N is equal to the number of nodes in the network. The network topology of the area to be studied is the represented as showed on Table 3.1

Table 3.1 Position of the nodes array

ID	1	2	3	...	N
X pos	x_1	x_2	x_3	...	x_N
Y pos	y_1	y_2	y_3	...	y_N

3.3.3 Antenna model

In general terms, an antenna is a device that is capable of radiating or collecting radio signals in all directions (omnidirectional case) or in a specific direction (directional case). Traditional wireless networks are equipped with omnidirectional antennas, but recently the research community has pointed out that directional antennas can improve the performance of such networks. A directional antenna can have a larger range compared to an omnidirectional antenna due to its directivity. The antenna gain is used to quantify the directionality of an antenna. For a given direction \vec{d} , the gain of a directional antenna is defined as:

$$G(\vec{d}) = \frac{\eta U(\vec{d})}{U_{avg}} \quad (3.1)$$

Where $U(\vec{d})$ is the power density in the direction of \vec{d} , U_{avg} is the average power density over all directions, and η is a parameter used to define the antenna efficiency and represents the losses related to hardware design. In this work, we assume that all the nodes in the network are equipped with a switched beamforming antenna array of N elements, the main lobe of each element is represented as a conical segment of $2\pi/N$ radians. For convenience, we assume that the gain of the side lobes is insignificant. We also assume that the antenna elements do not overlap and cover the entire plane when all them are used at the same time. We numbered the elements from 1 to N starting with the element located in the east (3 o'clock) position, following the same convention used in Zhou et al. (2007) as shown in Figure 3.1.

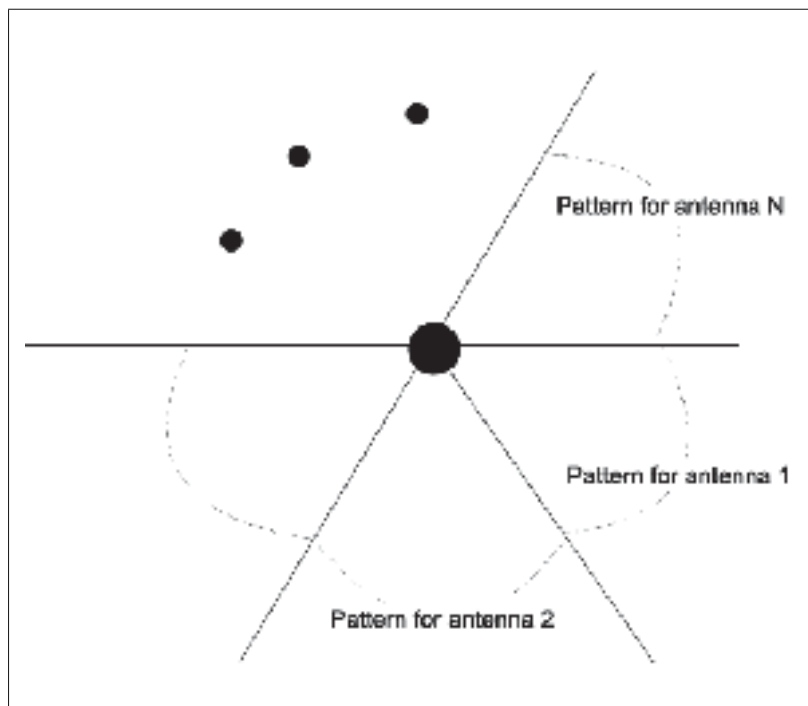

Figure 3.1 Antenna array installed in wireless nodes

3.3.4 Wireless Channel Model

In radio communications, the power transmitted decreases according to the distance traveled to the destination. This fact is called path loss, and according to Rappaport, Theodore (2002), it follows a power law that can be represented as:

$$P_a(r) = c \left(\frac{r}{r_0} \right)^{-\eta} \quad (3.2)$$

Where r_0 is a reference distance¹, the parameter η is commonly referred as the path loss exponent which can take values from 2 in free space to 6 in highly dense urban environments. The constant c depends on the transmitted power, gains of transmitting and receiving antennas, and the wavelength of the signal. As we are interested in the impact of the antenna gains, we rewrite the equation 5.2 in terms of the antenna gains as follows:

$$P_a(r) = P_t G_t G_r \left(\frac{r}{r_0} \right)^{-\eta} \quad (3.3)$$

According to the log-normal path loss model, the power received at node j from node i with a distance r_{ij} between them is equal to:

$$10 \log_{10} (P(r_{ij})) = 10 \log_{10} (P_a(r_{ij})) + x \quad (3.4)$$

Where x is a zero-mean normally distributed random variable (in dB) with standard deviation σ (also in dB). Notice that when $\sigma = 0$ the log-normal model reduces to the path loss model. Moreover, the condition to establish a link between two nodes is that the received power is greater than the receiver's sensitivity γ , therefore, the distance R where $P_a(r)$ is equal to γ is calculated using the Equation 5.2. In other words $\gamma = (R/r_0)^{-\eta}$. Following the method

¹ This distance is typically chosen to be 1m in indoor environments and 100 meters or 1 kilometer in outdoors Rappaport, Theodore (2002).

proposed by Hekmat and Van Mieghem (2006) we divide powers by γ and using the results of Equation 3.3 we have:

$$10\log_{10}\left(\frac{P(r_{ij})}{\gamma}\right) = 10G_tG_r\log_{10}\left(\left(\frac{r_{ij}}{R}\right)^{-\eta}\right) + x \quad (3.5)$$

$$10\log_{10}\hat{P}(\hat{r}_{ij}) = 10\log_{10}G_tG_r\left(\hat{r}_{ij}^{-\eta}\right) + x \quad (3.6)$$

$$p(\hat{r}_{ij}) = Pr[10\log_{10}\hat{P}(\hat{r}_{ij}) > 0] \quad (3.7)$$

$$\begin{aligned} &= \frac{1}{\sqrt{2\pi}\sigma} \int_0^\infty \exp\left[-\frac{\left(t - 10G_tG_r\log_{10}\left(\hat{r}_{ij}^{-\eta}\right)\right)^2}{2\sigma^2}\right] dt \\ &= \frac{1}{2} \left[1 - \operatorname{erf}\left(u \frac{\log(\hat{r}_{ij})}{\varepsilon}\right)\right] \end{aligned} \quad (3.8)$$

Where $\varepsilon \equiv \frac{\sigma}{\eta}$ is defined as the ratio between the standard deviation of the power variations and the signal path loss, and the parameter u defined as:

$$u = \left(\frac{10E[G_tG_r]}{\sqrt{2}\log 10}\right) \quad (3.9)$$

The effective beamforming gain $E[G_tG_r]$ depends on the type of antenna used. In this research work, we assumed a smart directional antenna with an uniform circular array (UCA) of N identical antenna elements spread in a circle of radius R in the xy -plane. According to Dai and Zhao (2015), the gain of the UCA is given by :

$$G = \frac{|E(\theta, \phi)|^2}{\frac{1}{4\pi} \int_0^{2\pi} \int_0^\pi |E(\theta, \phi)|^2 \sin(\theta) d\theta d\phi} \quad (3.10)$$

The problem of effective beamforming is a well studied fact. According to Zhou et al. (2007), there is no closed-form solution for the effective beamforming gain but it can be numerically evaluated using MATLAB. The summarized results are shown in Table 3.2.

Table 3.2 Effective Beamforming Gain
Adapted from Zhou et al. (2007)

Pathloss factor	No of Antennas	Beamwidth	Effec. Beamforming Gain
2	4	90 deg	1.48
2	6	60 deg	1.51
2	8	45 deg	1.60
3	4	90 deg	0.95
3	6	60 deg	0.96
3	8	45 deg	0.96
3.5	4	90 deg	0.87
3.5	6	60 deg	0.89
3.5	8	45 deg	0.90

The differences between the simple path loss model, the log-normal model and the model presented in this thesis, named as directional log-normal model, are illustrated in Figure 3.2. While the path loss model considers the coverage area of a transmitter as a perfect circled shape of radio R the log-normal model considers the medium scale variations in the vicinity of R which results in a more realistic scenario. Our model is based on the last mentioned, but it considers an increased range due to directionality in the main lobe of the antenna. Without power control, it is expected to have larger ranges in the direction of the steered beam or, in other words, a higher probability of having a link between distant nodes.

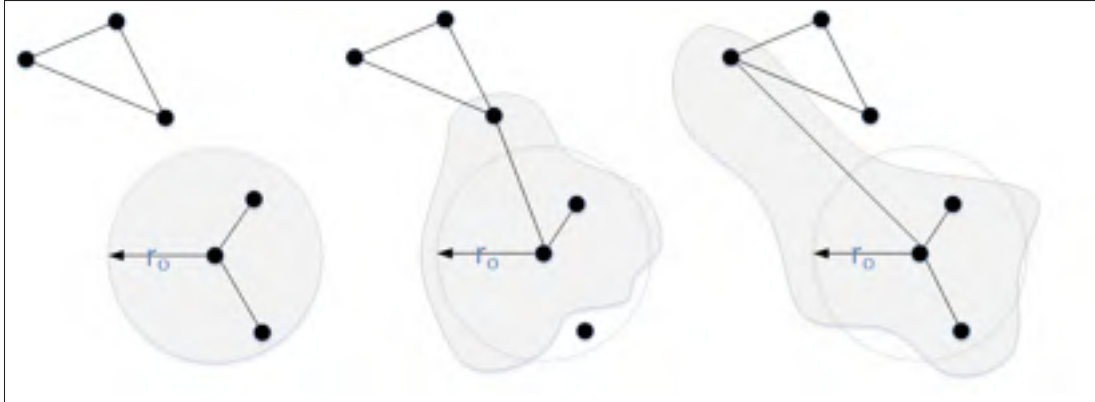

Figure 3.2 Different link models and resulting network topologies

3.4 Simulation Setup

Our simulations were carried out in Matlab version R2013A, we have evaluated the link probability of our log-normal model with directional antennas and compared with the omnidirectional log-normal model. In the first experiment, ten nodes were uniformly distributed over an $M \times M$ square shaped area, where M is equal to $2000m$. In this experiment, we assumed omnidirectional antennas for transmission and reception. Nodes have a coverage radius of $200m$ and we considered a path loss exponent $\eta = 3.5$. Once the nodes are deployed over the area to be studied, the neighbor list is generated using the Find Neighbors function described in Algorithm 3.1. Then, paths from every node to all the others are constructed using the Dijkstra shortest path algorithm. This experiment was repeated under the same conditions but increasing the number of nodes from 10 to 100 with a step of 10 nodes $\{10, 20, \dots, 100\}$. On each iteration, the position of the nodes was cleared and then uniformly distributed again. We also considered an ideal MAC layer which means that there is the same probability of having a successful transmission or collision. If a collision occurs, the packet is lost as retransmissions are not considered.

In the second experiment, we considered directional transmissions by introducing the log-normal link probability model with directional antennas. As in the first experiment, ten nodes were uniformly distributed over a $2000m \times 2000m$ square shaped area. We consider directional

patterns for transmissions and an omnidirectional pattern for reception. Once the nodes are deployed over the area to be studied, the neighbor list is generated using the Find Neighbors function described in Algorithm 3.1, but this time the link probability model that considers directional antennas was used. Then, paths from every node to all the others are constructed using the Dijkstra shortest path algorithm. Three different beamwidth angles were considered: 45, 60, and 90. Then the number of nodes was increased to twenty and we repeated the experiment for the three different angels mentioned before. We continued repeating the experiment but increasing the number of nodes in steps of 10 nodes until 100 nodes as in the previous experiment.

In both experiments the find neighbors algorithm behaves similarly, nevertheless they differ on the probability function used to determine if two nodes are neighbors or not. In the first experiment, the omnidirectional log-normal function was used while in the second experiment, the directional log-normal function was used. It is also important to remark that for these experiments the mobility of the nodes was not considered as we wanted to isolate the impact of the directional antennas in the link probability model.

Algorithm 3.1 Find Neighbors Function

```

1 row = 1;
2 for all node pairs do
3   | x = | xi - xj | ;
4   | y = | yi - yj | ;
5   |  $\hat{r}_{i,j} = NormDistance(x,y)$ ;
6   | if Pr [10log10 $\hat{P}(\hat{r}_{i,j}) > 0$ ] then
7   |   | plot([xi,xj],[yi,yj]);
8   |   | NList(row,1) = IDi ;
9   |   | NList(row,2) = IDy ;
10  |   | NList(row,3) = ri,j ;
11  |   | row ++ ;
12  | end
13 end

```

3.5 Analysis of Results

In this section, we present the results of our simulations as they were described in the previous section. We also discuss the main findings that we identified during this process. In order to keep concordance with the proposed solution, we have divided this task into two sections: the impact of directional antennas on the link probability model, and the hop count analysis.

3.5.1 Link Probability

The aim of this section is identifying the impact of the directional antennas (by considering the antenna gains) in the link probability model. Figure 3.3 depicts the results of our simulations regarding link probability. We present the results for antenna arrays with four elements (90° each element), six elements (60° per element) and eight elements (45° each element). The omnidirectional model is also presented here to compare versus the directional model. Two omnidirectional models were considered: the simple path loss model and the log-normal model. As we find in Section 3.3.4 the simple path loss model is a step function that represents the fact that any node inside the coverage area of a given node is connected to the node and any node outside this area has no connectivity with the node. This finding is represented in the figure as a step function at normalized distance $d = 1$ with probability $p = 1$ for any distance $d < 1$ and probability $p = 0$ for any distance $d > 1$.

Then, in Figure 3.3a we observe that as we increase the number of elements in the antenna array or, in other words as we narrow the antenna beam, the probability of having a link at greater distances than the normalized distance $d = 1$ increases compared with the omnidirectional case. This is an important finding because it demonstrates that as we narrow the beam of the antenna and the energy is focused in a particular direction we have an increment in the antenna range. As a consequence, the antenna is capable of reaching farthest nodes that are then included in the list of neighbors. If the number of reachable neighbors increases for a given node, it means that this node has increased its connectivity. Therefore, the full network connectivity is improved because more links are available and more alternative paths are available to construct

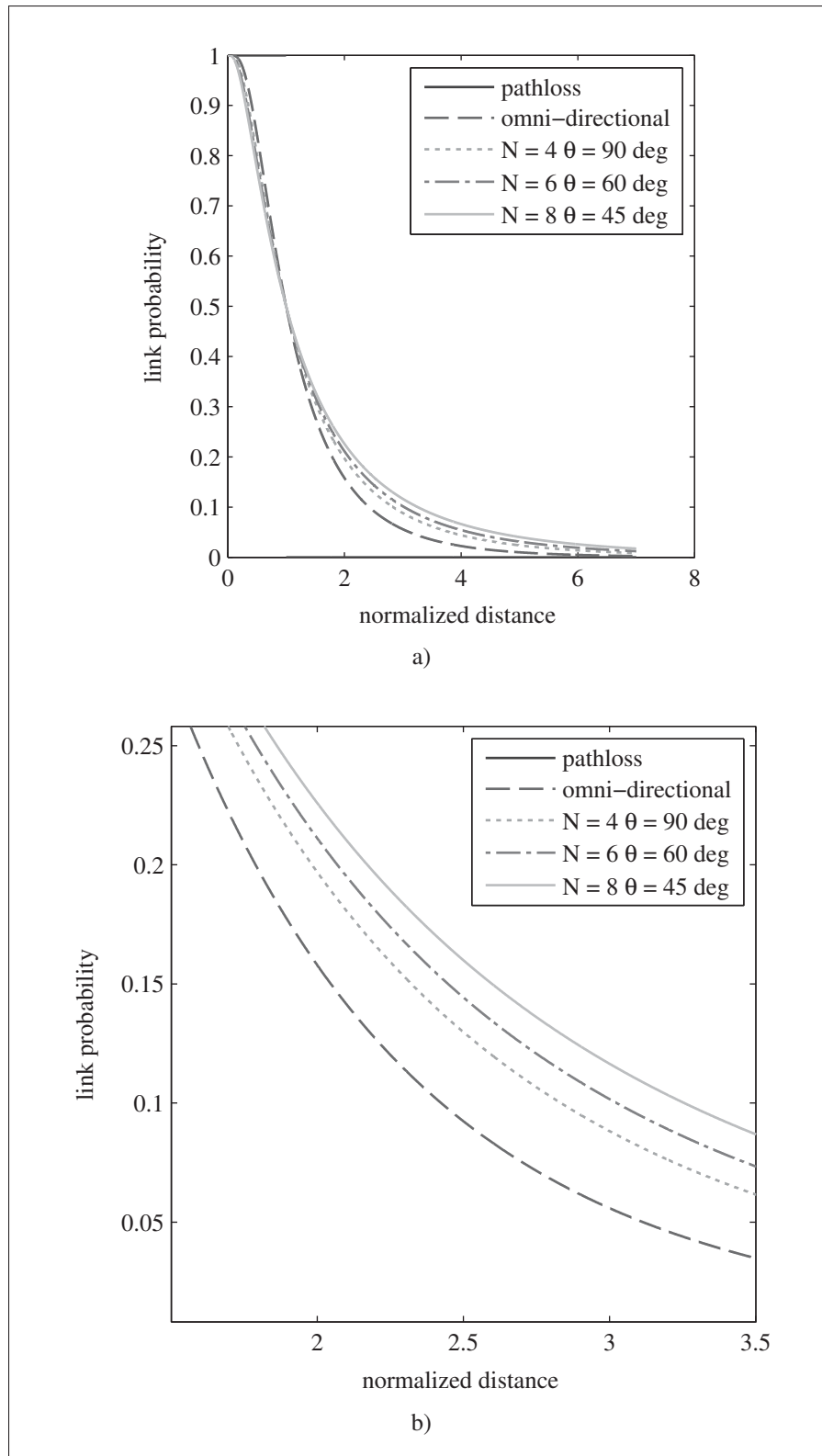

Figure 3.3 Link probability comparisons

the routes to destinations. To remark the increase on link probability, on Figure 3.3b we have zoom-in the values around the normalized distance=2.

Taking as an example the results around the normalized distance $n=2$ (twice the threshold range with omnidirectional antennas), we found that the probability of having a link between two nodes increases approximately 46% when we consider the directionality of the antennas. While around the normalized distance $n=3$ (three times the threshold range) the probability increases up to 78%. This result means that the model is correctly illustrating what we expect to find in a real scenario: with extended ranges consequence of the directional antennas, nodes that are farthest can be reached which translates in a better-connected network.

Finally, we point out that for normalized distance lower than $d = 1$, our model shows a slightly lower probability than the omnidirectional models. This can be explained as a consequence of the use of directional antennas because it is true that as we narrow the antenna beam, we have observed a higher probability of connection for longer distances as a consequence of the directivity of the antenna. Unfortunately, it also means that nodes that are closer to the transmitter, but in a different direction where the main lobe of the node is pointing, can appear as unconnected because they are outside the coverage area of the transmitting node. This last observation is commonly referred in the literature as the spatial diversity.

3.5.2 Hop count

To evaluate the impact of our model on the hop count, we have uniformly distributed 100 nodes in a square-shaped area of length equal to 2000 m. Then we used the link probability defined by Equation 4.5 to create links between the nodes. Once the links were created, we called the function Find Neighbors to identify all the possible paths between source and destination. We have considered four scenarios: omnidirectional transmissions (effective gain=1), and three directional scenarios with 4,6 and 8 antenna elements.

Figure 3.4 shows the resultant network graphs. Fig 3.4a represents the omnidirectional case, Fig 3.4b shows the results when 4-elements smart antennas are used. Fig 3.4c represents the

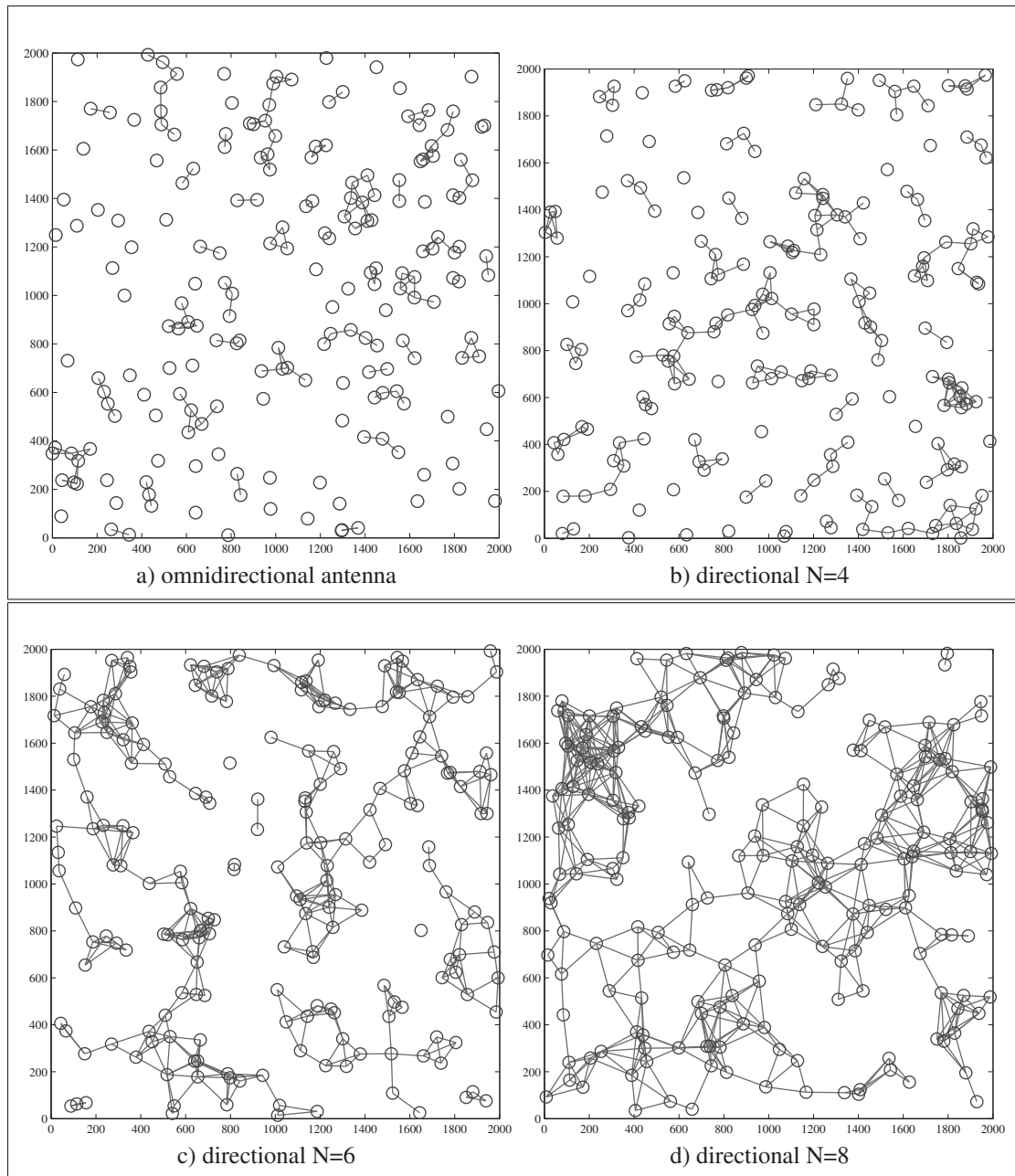

Figure 3.4 Nodes and links over a service area for different antenna configurations

case with 6 antenna elements and Fig 3.4d, shows the results obtained when 8-elements antennas are used. From the image sequence, we notice that as we narrow the beamwidth of the main lobe, the number of links between the nodes in the network increases. Consequently, any pair of source-destination node will have more paths available to transport data or in other words,

the connectivity of the overall network improves. Although we can observe in the pictures that the number of lines that represents the links between nodes have been increased as we narrow the beams, we consider that this observation is subjective and it is necessary to find an objective parameter that can be measured. For this reason and based on observations made in previous works, we utilized the hop count as a parameter to measure the connectivity in the network. On each iteration we have stored in the matrix HCount the number of hops in a route after each iteration.

Finally, we analyze the hop count in terms of the mean hop count. The mean hop count is the average distance between any pair of nodes or, in other words, the average path length. In figure 5 we compare the two models: omnidirectional and directional with 8 antenna elements. We can see a reduction in the mean hop count from 6.35 to 4.53 which means that the distance (in hops) between any pair of nodes in the network has been reduced. Paths with fewer hops are beneficial for the network performance because shorter paths imply a reduction in the end-to-end delay between any pair of nodes in the network.

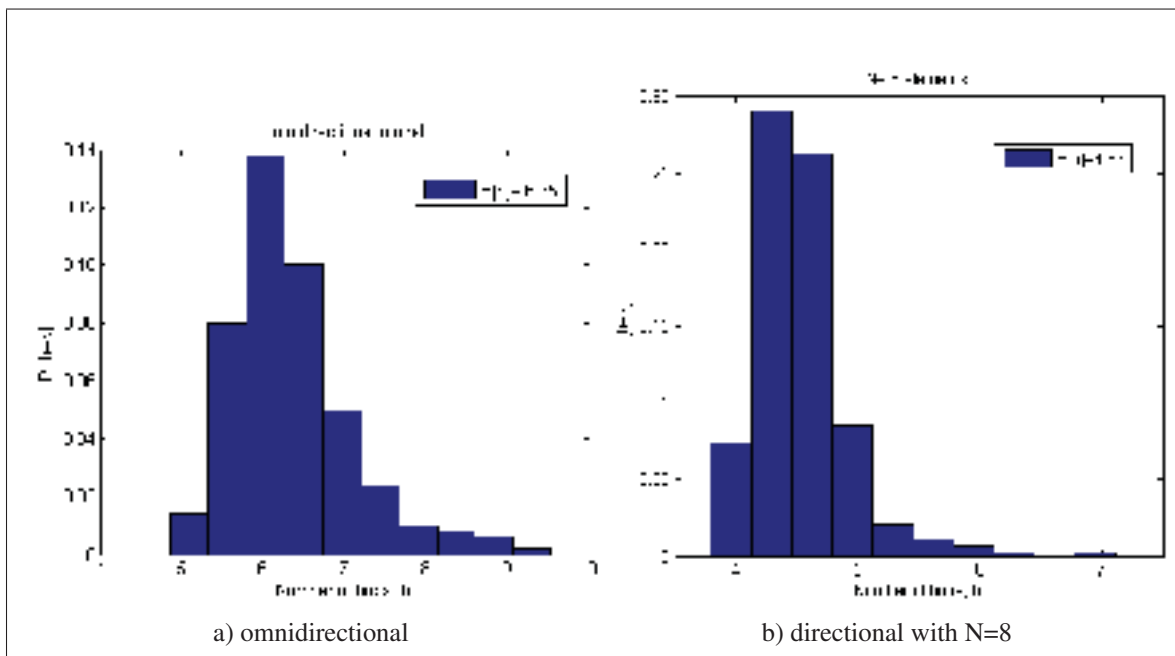

Figure 3.5 Hopcount comparison: omnidirectional vs. directional model

In this chapter we investigated the impact of directional antennas on the modeling of wireless ad-hoc networks. Specifically, we proposed a novel link probability model that considers the directional gain of the smart antenna arrays. Through simulations, we have demonstrated that it is possible to achieve a higher network connectivity when directional antennas are considered into the model. We have also demonstrated that as the main lobe of the antenna array is narrowed the probability to have a link with nodes that are farthest is higher when the effective gain of the antennas is considered. In terms of the hopcount, we have also noticed a reduction in the mean hopcount when the directional model is used. He have also verified that fewer hops in any path between a source and destination node leads to an improved performance as was previously presented by Dai and Zhao (2015) because less hops in a route implies less delay as consequence of the message processing on each node in the route and time spent in propagation.

Mobility of the nodes was not considered in this section as we wanted to aise the impact of directional antennas in the link probability mode for ad-hoc networks. We consider that mobility is an important factor to analyze and it will be interesting to include in a future analysis. Further, we also notice that the mathematical model considered in our analysis contains some simplifying assumptions including: first, the directional antenna gain is a constant in its mainlobe; second, the transmission distance is uniform over all directions within the mainlobe; third, a uniform transmission rate is assumed by all communications. Removing any of the above simplifications in the analysis will provide a more realistic model and can be a very interesting future direction. Besides, this model is a fundamental study that contributes into the mathematical model of ad-hoc networks but it will be interesting to analyze the impact of directional antennas in a more realistic scenario. For example, instead of using the shortest path algorithm to calculate the routes between source and destination will be interesting to evaluate the performance when a reactive protocol such as AODV is used. Finally, in this section we considered the extended range that can be achieved when the beams are narrowed and we used fixed beams (45° , 60° and 90°). It is of particular interest to evaluate the improvements in the

performance of the network if the beam can be selected as required (adaptive beams). All this interesting and open research questions will be addressed in the next chapter.

CHAPTER 4

NEIGHBOR DISCOVERY AND ROUTING SCHEMES FOR AD-HOC NETWORKS

4.1 Introduction

A mobile ad-hoc network (MANET) is a self-organized, infrastructure-less set of nodes that can communicate with each other over wireless links. The rapid deployment, low cost, and robustness of this type of networks are key features that are very appealing for applications like military and recovery disaster networks, wireless sensor networks, vehicular networks and many similar others. In infrastructure networks, such as cellular networks, the communications are performed on a one hop basis between the base station and the mobile station, whereas in ad-hoc networks two nodes are commonly connected through multiple hops. This means that nodes in these networks also forward packets acting as relays. For these reasons routing in such networks is a challenging task that can not be performed by the same routing protocols developed for wired networks.

Traditional routing protocols for MANETs were initially designed and developed considering omnidirectional antennas installed on the nodes. However, recent studies have suggested that the use of directional antennas can considerably increase the throughput of these wireless networks. In this article, we introduce a novel routing algorithm for MANETs where the wireless nodes are fitted with smart directional antennas. The algorithm aims to take full advantage of the beamforming features of smart antennas. The primary objective of our routing algorithm is to reduce the number of hops in the route between a source and destination node by using the location information of the nodes participating into the routing path gathered during the neighbor discovery process. In this work, we refer to the location as the last angular sector where the node was seen. This information is taken from the antenna element used to discover the node. Although the location information obtained by this mechanism is not as precise as a GPS positioning system, we can use it as a first step for a more complex location system which also uses the information provided by the neighbor discovery algorithm proposed in this

work. This method can be handy when devices are located in dense areas (e.g., downtown, inside a building, at underground commercial complexes), on devices without a GPS or within particular application networks such as disaster discovery networks, unmanned aerial vehicle networks, and firefighting robot networks.

When it is time to select the next hop of the routing path, the decision-making process in the algorithm is supported by a novel neighborhood discovery process also proposed in this article. During the neighborhood discovery, a four-way handshake method is used where the nodes interchange the antenna sector used to discover each other. The capability of controlling the range and coverage by varying the beam width angle is used in our algorithm to limit the neighborhood search in the vicinity of a node. In this chapter we present:

- A gossip neighborhood discovery algorithm that uses the information provided by directional antennas to discover neighbors in the second neighborhood of the node using directional beams;
- A routing algorithm that aims to reduce the number of hops during the route construction using the information provided by the neighborhood discovery algorithm also proposed in this article and;
- A comprehensive comparison between the scheme suggested in this article and similar solutions previously developed.

4.2 Overview

4.2.1 Neighbor Discovery

One of the distinctiveness of MANETs is their self-configuring capability, which means that the network does not need a centralized unit to perform the tasks required to keep the network functioning. Neighborhood discovery is one of the self-configuring tasks that is done once nodes are deployed; it allows each node to discover its surrounding neighbors. Then, this in-

formation is used by the upper layer protocols such as topology control, medium access control and routing protocol to perform their tasks. A lot of research has been done in this area. For example, Vasudevan et al. (2005); McGlynn and Borbash (2001); Keshavarzian et al. (2004); An and Hekmat (2007) considered the type of antenna used. We gather from these articles that there are two types of neighbor discovery algorithms depending on which antenna type is used: omnidirectional and directional neighbor discovery. McGlynn and Borbash (2001) and Keshavarzian et al. (2004) present two algorithms for neighbor discovery in wireless ad-hoc networks where nodes have omnidirectional antennas. While the algorithm proposed in McGlynn and Borbash (2001) can operate in asynchronous mode, synchronization is a requirement for the algorithm described in Keshavarzian et al. (2004).

Previous research also suggested neighbor discovery algorithms using directional antennas. In Vasudevan et al. (2005), the authors develop several algorithms considering three approaches: directional transmission and omnidirectional reception (DO); directional transmission and reception (DD); and omnidirectional transmission and directional reception (OD). Each of these three strategies is first evaluated considering a direct discovery algorithm, which means that a node discovers its neighbors only when it successfully hears a transmission from that neighbor. Then, the strategies mentioned before are evaluated considering a gossip-based discovery algorithm where nodes gossip about each other's location information to speed up the discovery process. The gossip-based algorithm allows a node to discover its neighbors indirectly and also allows a node to discover many neighbors in the same step. The results of this work showed that those differences help nodes to discover their neighbors significantly faster than using a non-gossip discovery algorithm. The main drawback to gossip-based algorithms proposed so far is that they assume that each node obtains its location information using a GPS device and, if the number of nodes equipped with GPS is reduced, the performance of the discovery algorithm also degrades correspondingly. In An and Hekmat (2007) the authors introduce an original neighbor discovery algorithm with directional antennas counting the mobility of the nodes and improving the energy consumption. For the first problem, the cycle of the neighbor discovery is self-adapted according to the dynamics of the network. Further, to improve the

power efficiency and reduce overhead, the protocol can limit neighbor discovery attempts in regions where no new neighbors are likely to be found. This work does not take into consideration multi-hop system and only discovers one-hop neighbors.

Latterly in Zhang and Li (2008) the authors describe 2-way random neighbor discovery algorithms based on algorithms proposed in Vasudevan et al. (2005). Four algorithms were proposed; two of them using omnidirectional antennas in certain stages of the algorithm and the other two using directional antennas all the time. The shortcoming of this work is that it does not consider the gossip-based approach and for synchronization purposes, it requires the nodes to have GPS devices.

Finally, Ramanathan et al. (2005) proposed several neighbor discovery methods(NB) based on the usage of the directional antenna to transmit or receive data. According to this paper, there are three kinds of NB methods: N-BF(without beamforming), T-BF(using beamforming only on transmission) and TR-BF(using beamforming on transmission and reception). Through simulations, the authors concluded that the use of beamforming on both, transmission and reception offers a higher throughput due to the higher bandwidth available when using directional antennas but it also increases the packet loss due to the synchronization required to point both antennas in the same direction at the same time. However, the solution where directional antennas are used for transmission and omnidirectional antennas are used at reception offers a better-balanced performance. Because there is a reduction in the total throughput of the network, but it is compensated with an improvement in the packet loss ratio because a pointing mechanism is not needed when the omnidirectional antennas are used for reception. Based on this fact, we assume an omnidirectional or directional transmission and always omnidirectional beamforming at the reception node.

4.2.2 Routing Algorithms

Since the first development of routing protocol for mobile ad-hoc networks, researchers have shown their interest to support the routing decision based on the position of a node in order

to increase the packet delivery ratio and reduce the end-to end delay. In the literature, there are several implementations of both reactive and proactive routing protocols. For example, Ko and Vaidya (2000) proposed a reactive routing protocol, Location Aided Routing (LAR) which uses the position information obtained by a GPS sensor to limit the search for a route to the so-called request zone, determined based on the expected location of the destination node at the time of route discovery. Simulation results indicate that using location information results in significantly lower routing overhead, as compared to an algorithm that does not use location information. Drawbacks of this approach are the need for GPS and the reactive nature of the protocol which increases the setup delay of a route. Later, Basagni et al. (1998) proposed a proactive protocol where the nodes need the position information from a GPS to calculate the path to the destination. The entire network is divided into hierarchical zones within the information about the position of nodes is distributed. Drawbacks of this approach are the dependency to the GPS sensor, and also the mobility of nodes between zones creates an unnecessary overload. Recently, Quintero et al. (2007) developed LEOD, a framework that uses the information provided by smart antennas to determine the position of the nodes in the network and using this information, discover and maintain routes. The positioning algorithm only considers one-hop neighbors and the method used for estimate de position is based on the angle of arrival (AoA) technique, which is a time sensitive estimation.

4.3 System Model

In this section we describe the antenna model used in this work, then we define the beamforming capabilities required by the neighborhood discovery and routing algorithms to perform as desired.

4.3.1 Antenna Model

In this study, we assume a switched beam antenna array formed by N elements which can focus more energy on a predefined direction. The coverage area is divided into N non-overlapping sectors, and the angle θ for each sector is given by Equation 4.1.

$$\theta = \frac{2\pi}{N} \quad (N > 1) \quad (4.1)$$

Figure 4.1 describes the antenna model. We have numbered the sectors from 1 to N, starting from the beam that is on the three o'clock or east position. The antenna array can work in two modes: directional and omnidirectional. The omnidirectional pattern is created by setting the gain of all the beams at the same level. This beam form is used only for reception mode while the directional mode can be used for transmission or reception as required. The nodes can be in one of three possible status: idle, transmission or reception. When idle, each node listens for signals in all directions. The interference created by the side lobes is ignored because they are considered small compared with the signal received in the main lobe, and typically this interference is not desired.

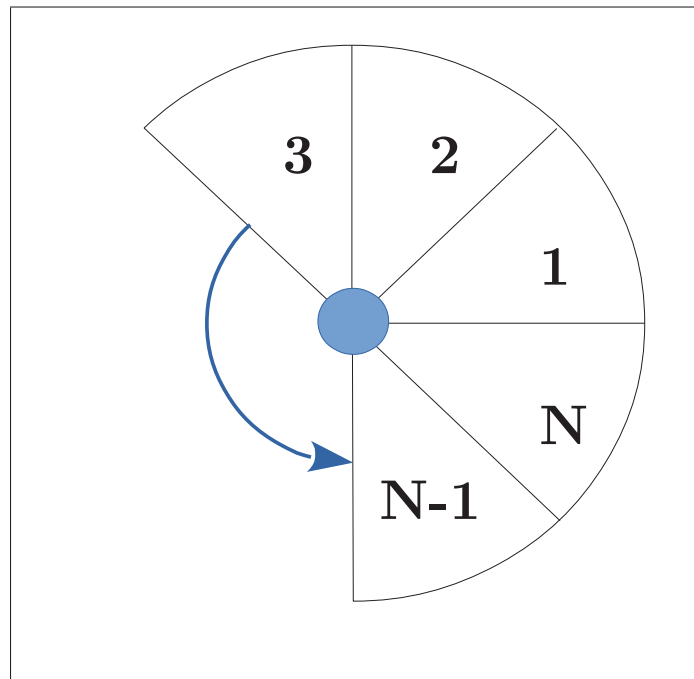

Figure 4.1 Antenna model for the switched beam array

4.3.2 Beamforming

For the beamforming, we assume that each antenna element in the array is capable of forming a beam with a default opening angle θ that can be narrowed or spread as required to control the transmission range. This concept was first introduced by Chen and Jiang (2007). Three patterns with different opening angles were defined: wide angle $WA(\theta)$, half-wide angle $HWA(\theta/2)$ and narrow angle $NA(\theta/4)$. We assume that if the transmission power remains constant, a variation in the beam's opening angle results in a variation of the range and coverage area of the antenna as shown in Figure 4.2.

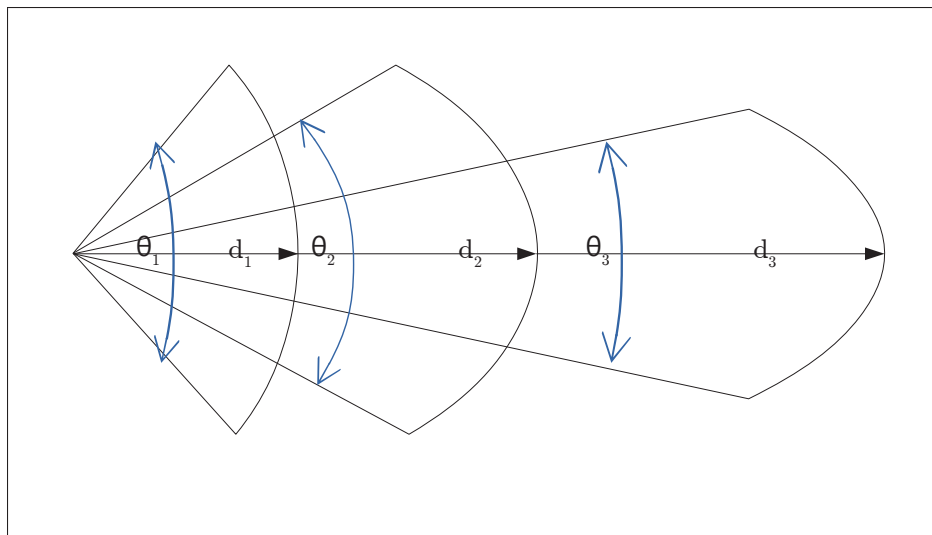

Figure 4.2 Angle vs distance relationship

Our approach differs from the one proposed by Chen and Jiang (2007) because we vary the opening angle of the beam instead of varying the transmission power to control the coverage range of the antenna. The advantage of our approach is that we preserve the energy in the nodes by keeping the power constant. In this context, it is necessary to determine the antenna's range as the function of the beam angle so we can determine in which zone of coverage the neighbor node is located. First let's write the received power P as function of the distance d as defined in Rappaport, Theodore (2002):

$$P_R(d) = \frac{P_T G_T G_R \lambda^2}{(4\pi)^2 d^2} \quad (4.2)$$

As we consider omnidirectional beamforming at the receiving node in any case, we need to find the receiving power in the following two cases: the directional-omnidirectional (DO) and all omnidirectional (OO) connections:

$$P_{R_{OO}} = \frac{kP_T}{d_{OO}^2} \quad (4.3)$$

$$P_{R_{DO}} = \frac{kG_T P_T}{d_{DO}^2} \quad (4.4)$$

Then, we define R as the distance d where the received power is equal to the power threshold P_{TH} . As we are writing the power equations from the receiver point of view, the threshold power is always the same for both cases (DO and OO) because we use the directional mode only for transmissions. Therefore, we equate Equation 4.3 with Equation 4.4 in order to obtain the relationship between the transmission gain G_T and the antenna range d :

$$\begin{aligned} P_{TH} &= P_{R_{OO}} = P_{R_{DO}} \\ \frac{kP_T}{d_{OO}^2} &= \frac{kG_T P_T}{d_{DO}^2} \\ d_{DO} &= d_{OO} \sqrt{G_T} \end{aligned} \quad (4.5)$$

Later, we define the distance in omnidirectional mode as the known distance d_o and we also define d such as $d > d_o$; as the distance in DO mode which is function of d and G_T . Then

using the relation defined in U. of Hawaii (2007) we have:

$$\begin{aligned}
 G &= \frac{\text{Area of Sphere}}{\text{Area of Antenna pattern}} \\
 &= (4\pi r^2) \left(\frac{4}{\pi r^2 \sin \theta \sin \phi} \right) \\
 &= \frac{52525}{\phi \theta (\text{degrees})}, \text{ if } \theta = \phi : \\
 G &= \frac{52525}{BW_\phi^2} \tag{4.6}
 \end{aligned}$$

Finally, we can have an expression where the distance d can be written as the function of the beam angle ϕ , by replacing Equation 4.5 in 4.6:

$$d = d_o \frac{\sqrt{52525}}{BW_\phi} \tag{4.7}$$

The distance d_o which is commonly defined as the range of the antenna can be obtained by measurements in field tests or calculated using Eq.(4.2). Besides, to account for links gain variation due to fading each node periodically broadcasts a control frame at a fixed, known power, so that all neighbors can estimate the link gain based on the received power. The relationship between the omnidirectional range, the beamwidth, and the directional range is described using the Figure 4.3.

4.4 Proposed Solution

In this section, we present a gossip based algorithm for neighbor discovery and a routing mechanism for ad-hoc networks that use the smart directional antennas to reduce the number of hops between the source and destination nodes. We start describing the neighborhood discovery algorithm, and then we finish the section with the proposed routing mechanism.

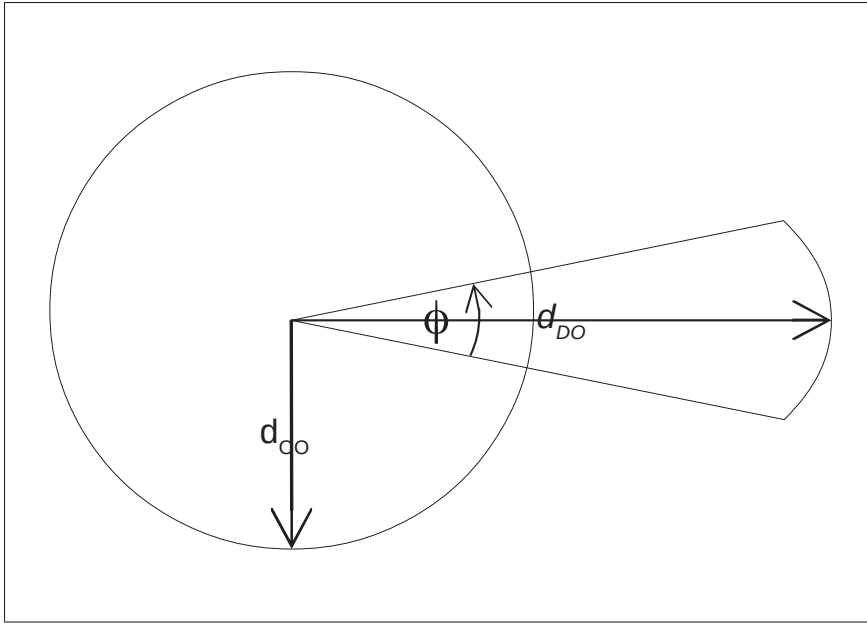

Figure 4.3 Omnidirectional vs. directional range

4.4.1 Neighbor discovery

The neighbor discovery algorithm proposed in this paper utilizes a synchronized four-way handshaking mechanism and assumes that there is a universal timing source that synchronizes all the nodes in slots over the same timeline. Each time slot is divided into four sub-slots. At the beginning of each time slot, every node selects a mode between transmission, reception or idle in the same way as proposed in Liu et al. (2013) with probability p_t, p_r or p_i . If transmission mode is selected in the first sub-slot, the node performs a search using a directional beam with an angle θ equal to the greatest possible angle that can be formed by the antenna elements. This fact means that the coverage range is similar to the one that can be achieved with an omnidirectional beamforming assuming that the power remains constant as proposed in Equation 4.7.

The search is performed sequentially and following the clockwise direction, and the antenna element that starts the search is selected at random as shown in Figure 4.4. The unique ID and the antenna element number used for the transmission is included in the DM before being transmitted. Any node in the surroundings of node i which receives the discovery message(DM)

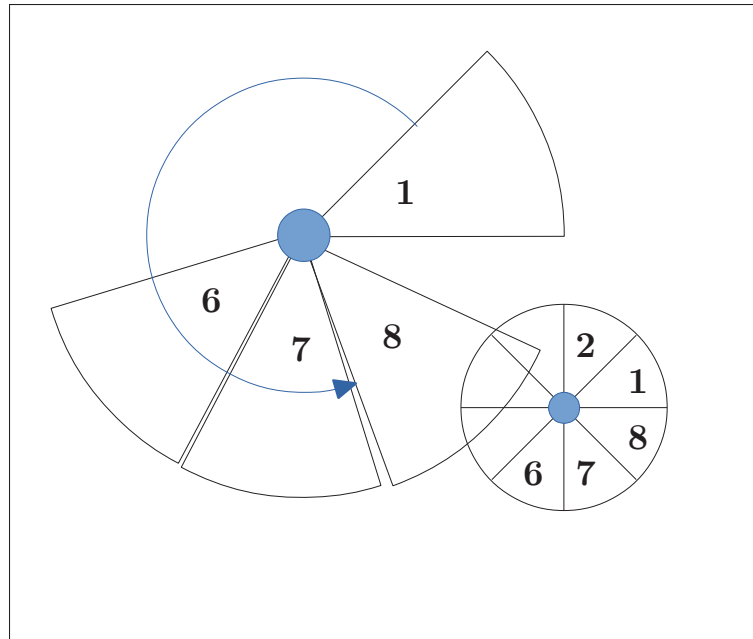

Figure 4.4 Antenna clockwise scan

stores the sending node's unique id, the beam where it received the DM and, if included in the DM, the information about the sending node i and all the other nodes previously discovered by node i . If the node selects reception in the first time slot, it listens omnidirectionally by setting all the antenna elements at the same level. If the idle mode is selected, the node keeps silence during the sub-slot.

In the second sub-slot, nodes that transmitted in the first sub-slot listen omnidirectionally. If an acknowledgment is received from its neighbors, the node stores the information related to the nodes in the first and second neighborhood in a table and calculates the direction required to reach these nodes located in the second neighborhood. Then using equation 4.7 the node can determine which neighbors are reachable using a more directional link. Nodes that have been in reception during the first sub-slot and have received a DM in the first sub-slot, now feedback by setting a directional beam using the same antenna element on which they received the DM and setting the same angle θ that was used by node i to transmit. Then it replies an acknowledgment message which includes the information about all the nodes that node j has previously discovered such that both nodes i and j now know about the nodes located in

the second neighborhood of each other. The node transmits with probability p_t and listens with probability p_r . Nodes that have been idle in the first sub-slot remain in silence to avoid collisions.

In the third sub-slot, nodes that have selected transmission and received an acknowledge in the second sub-slot will try to reach the nodes in the second neighborhood to confirm that they are reachable using a more directional beam width. The node sets a directional beam with angle $\theta/4$ and starts a search on the sectors where there are possible neighboring nodes. Nodes that have selected reception and has received an advertisement packet in the second sub-slot, now listen omnidirectionally with p_r and keep silence with $1 - p_r$. Nodes in idle mode keep silence to avoid collisions.

Finally, in the fourth sub-slot nodes in transmission mode listen omnidirectionally. If an acknowledgment is received from the nodes in the second neighborhood, the node marks these nodes as active. If there is no response from neighbors in the second neighborhood these nodes are discarded. Nodes in reception mode who have received an advertisement in the third sub-slot transmits an acknowledgment message with p_t and keeps silence with $1 - p_t$. Nodes in idle mode remain inactive.

4.4.2 Directional Routing

In this section, a novel routing scheme for wireless ad-hoc networks is described. The aim of this mechanism is to reduce the number of hops in the route between a source and the destination node using the extended range that can be achieved with smart directional antennas. The extended range in conjunction with the information about the nodes in the second neighborhood of a node obtained from the neighbor discovery algorithm proposed previously in this article are used to reduce the number of hops in a route as illustrated in Figure ???. The algorithm is intended to be used in a reactive routing protocol such as AODV by Perkins et al. (2003) or DSR by Johnson and Maltz (1996); where the routes are discovered only when needed. In this study, we incorporated the developed scheme into AODV, and we named it as directional

Algorithm 4.1 4-way handshaking with extended range

```

1 for each time slot do
2   for each node  $i \in N$  do
3     Init: Each node chooses an operating mode: tx, rx or idle, with  $p_t$ ,  $p_r$  or  $p_i$  ;
4     In the current slot: Set scan direction as  $\varphi$  and scan beamwidth as  $\theta$ ;
5   end
6   /* In the first sub-slot */
7   if present mode = transmission then
8     transmit a discovery message in direction  $\varphi$  with beamwidth  $\theta$ ;
9     else if current mode = reception then listen omnidirectionally;
10    else if current mode = idle then keep silence;
11  end
12  /* In the second sub-slot: */
13  if current mode = transmission then
14    listen omnidirectionally;
15    else if current mode = reception then
16      transmit NL in the contrary direction of  $\varphi$ , with  $p_t$  or keep silence with  $1 - p_t$ 
17    end
18    else if current mode = idle then keep silence;
19  end
20  /* In the third sub-slot: */
21  if current mode = transmission then
22    transmit a discovery message with direction  $\psi$  with BW  $\theta/4$ ;
23    else if current mode = reception then
24      If the node has received an discovery message in the second sub-slot, listen
25      omnidirectionally with  $p_r$  or keep silence with  $1 - p_r$ 
26    end
27    else if current mode = idle then keep silence;
28  end
29  /* In the fourth sub-slot: */
30  if current mode = transmission then
31    listen omnidirectionally;
32    else if current mode = reception then
33      If the node has received a discovery message in the third sub-slot, transmits a
34      reply message with probability  $p_t$  or keeps silence with probability  $1 - p_t$ 
35    end
36    else if current mode = idle then keep silence;
37  end
38 end

```

with extended range AODV (DXR-AODV). In the next section, we will describe the modifications performed by our algorithm into the two main stages of a reactive routing protocol: route discovery and route establishment.

4.4.3 Route Discovery

The Route Discovery stage comprises two procedures: The Route Request and The Route Reply. For a better explanation, we assumed that a source node S needs to send data to a destination node D and at $t = 0$ there is not a valid route to D in S route table. As a consequence, the source node S initializes a route request procedure by broadcasting a route request message (RREQ).

At this point, we introduce the concept of neighborhoods to classify the nodes that surround a given node regarding proximity. Nodes in the first neighborhood are nodes that can be directly reached with the omnidirectional range of the antennas and that have been discovered with the neighbor discovery process. On the other hand, nodes in the second neighborhood are nodes that can not be reached with omnidirectional ranges but are neighbors of a neighbor and any given node knows about their existence because the neighbor discovery gossip based algorithm notified about them to the node.

As Figure 4.5 depicts, the traditional AODV protocol broadcasts the RREQ message to all the nodes that are in the first neighborhood of the node using omnidirectional antennas or in other words they sent the RREQ to all the nodes that are one-hop far from the node. In our approach, the source node S have learned during the neighborhood discovery process that it has a node I in the second hop neighborhood which is reachable if node S uses a directional link instead of the omnidirectional beamforming. Therefore, node S will flood the RREQ to the nodes that are in the first neighborhood as well as to the nodes that are in the second neighborhood of the node using the directional beams. The intermediate node that receives the RREQ compares the Source Node Identifier (SID), Destination Node Identifier (DID) and Sequence Number (SEQ) to check if the message was previously received and by doing this it avoids unnecessary

loops. Once the RREQ arrives at the destination, the node D initiates a Route Reply procedure by unicasting a route reply message (RREP). Nodes D and intermediate nodes send the RREP message using the extended directional links where available, if not, the nodes can always use the alternative paths as shown in Figure 4.5.

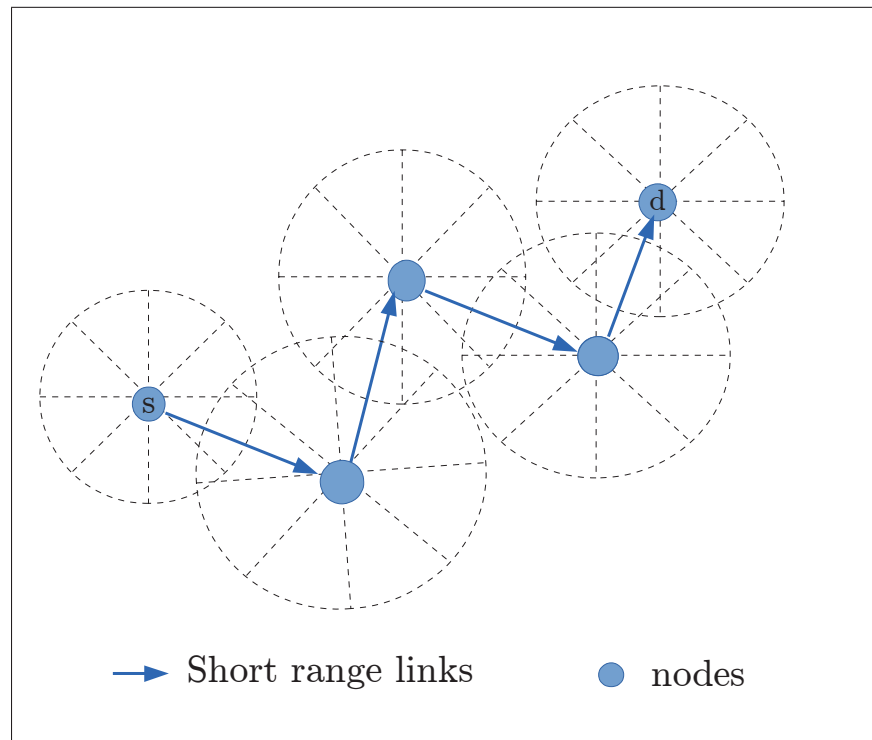

Figure 4.5 Route discovery with omnidirectional antennas

4.4.4 Route Establishment

In the traditional AODV protocol once the source node receives the RREP message the node S starts to send data to the destination node using the route learned during the route discovery. As nodes in MANETs are constantly changing their positions, the routes become unstable, and if a link is broken in the path between source and destination, the route needs to be repaired or if that is not possible the source node needs to start a Route Request procedure again. In both cases, the network is flooded with messages that increase the overload traffic and as a consequence reduces the throughput of the network. To couple with this issue, DXR-AODV

takes advantage of the redundancy in the routes provided by the extended directional ranges. The protocol will first try to deliver the data to the next node in the route using the directional links (Figure 4.6). If after a given period, there is no confirmation of the reception of the data, the node will use the traditional route which is formed by the short range links or single hop path as in the traditional AODV protocol.

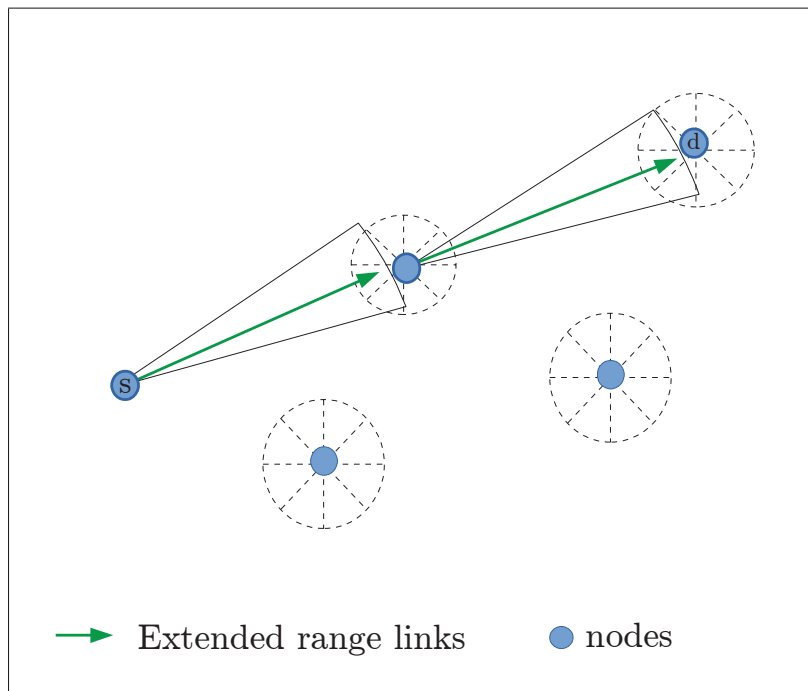

Figure 4.6 Route establishment with directional antennas

4.5 Simulation Setup

We conduct our simulations on MATLAB R2013A (MathWorks (1998)) where a mobile ad-hoc network was implemented. The nodes are assumed to have smart directional antennas installed. For mobility, the random waypoint model (RWP) was used as defined in Bettstetter et al. (2003) with a minimum velocity of 5m/s and a maximum of 10m/s and a pause time of 5s. Nodes were randomly placed over a square shaped area of 2000 x 2000m, and the number of nodes varies from 100 to 1000. The data traffic rate is constant, and it comes from the sequence

of packets delivered for a given source-destination pair in the network. The complete list of parameters used in the simulations is presented in the Table 4.1.

Table 4.1 Simulations setup

Parameter	Value
Area	2000m x 2000m
Number of Nodes	100,200...1000
Mobility Model	Random waypoint
Min. velocity	5 m/s
Max. velocity	10 m/s
Pause	5 s
Simulation Duration	3000 s
Packet size	512 bytes
Packet rate	2 pckts/s
Hello interval	1s
Antenna elements (N)	8 per node
Antenna gain	14 dB
Range	200m (omnidirecitonal)

4.6 Results Analysis

In this section, we evaluate the results obtained through the simulation described in section 4.5. The AODV (Perkins et al. (2003)) and LEOD (Quintero et al. (2007)) protocols are used as performance reference to compare versus DXR-AODV. We evaluated the following parameters: end-to-end delay, packet loss, and throughput.

4.6.1 Average end to end delay

As it is shown in the figure 4.7 for networks with less than 300 nodes we observed that LEOD and DXR-AODV perform similarly in terms of average end-to-end delay, while AODV has a higher end-to-end delay average compared with the directional counterparts of this protocol. This result is what we were expecting as it has been extensively demonstrated in the literature that directional antennas can be helpful to reduce the latency in MANETs Alshabtat et al.

(2010). Nevertheless, when we compared LEOD versus DXR-AODV we observed that as the number of nodes in the network reaches the 400 nodes and up our proposed protocol starts to outperform LEOD. We found that the main reason for this is that DXR-AODV is devoted to reducing the number of hops in a route between source and destination and the reduction in the number of hops has a direct impact on the end-to-end delay. This result is coherent with the results that we obtained previously in an analytical model that we developed in Astudillo and Kadoch (2015)

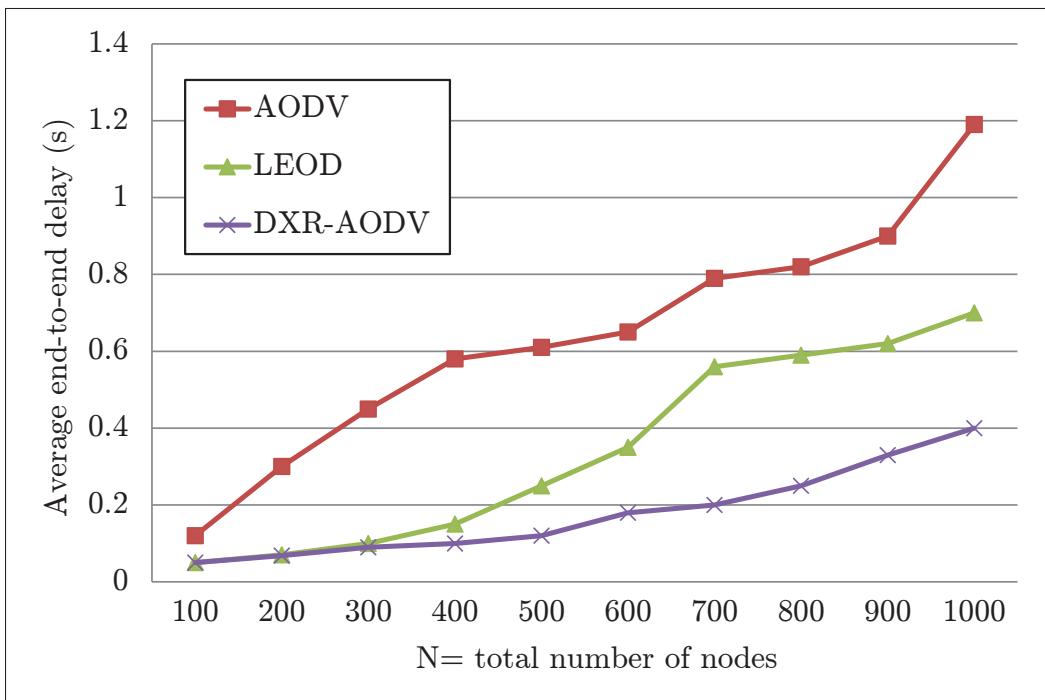

Figure 4.7 Average end-to-end delay

4.6.2 Packet loss fraction

The packet loss parameter is evaluated as the percentage of packets lost over the total of packets transmitted. The simulations showed that DRX-AODV outperforms both AODV and LEOD. This fact can be explained as consequence of two factors. The first reason is that DRX-AODV offers alternative paths between source and destination because if the extended directional route is not available, the node can always send the data using the long path as in traditional protocols

such as AODV. The second reason is that the number of packet collisions also decreased due to the improved neighbor discovery algorithm which uses directional links, so increases the spatial reuse and also implements an idle status in the nodes when they are not transmitting or receiving which means that these nodes keep silence to avoid collisions.

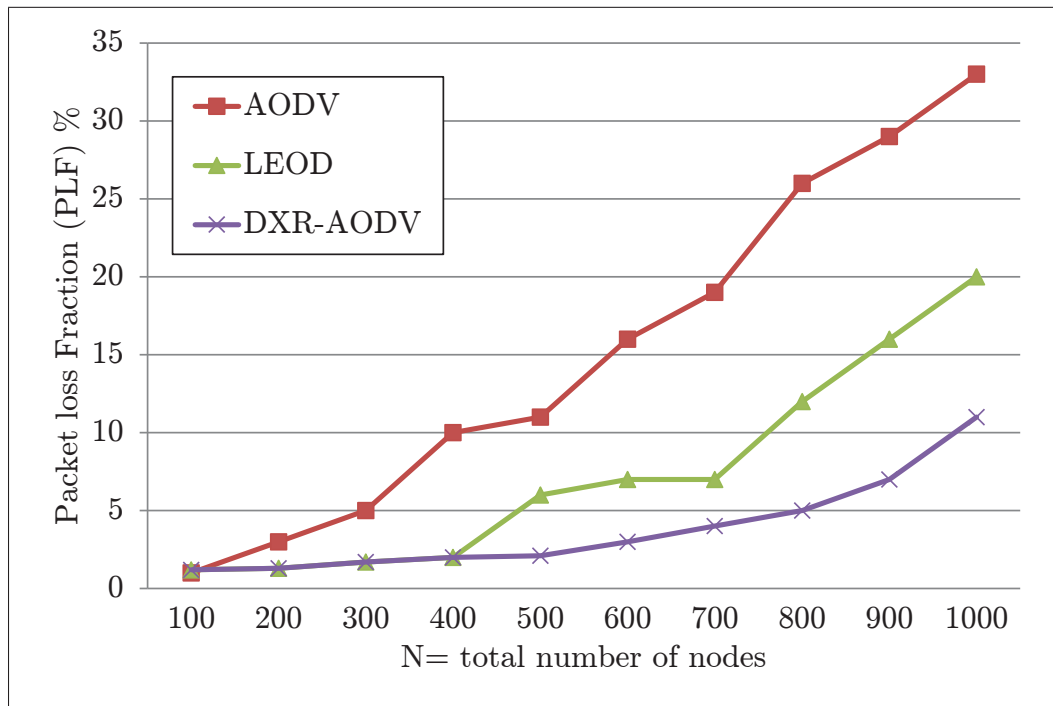

Figure 4.8 Packet lost

4.6.3 Throughput

The simulations showed an improvement regarding throughput when DXR-AODV is compared versus LEOD and AODV. As depicts in Figure 4.9, the three protocols perform similarly when the number of nodes is not larger than 200 but as the network size increases AODV and LEOD degrades faster than DXR-AODV. We found that this improvement in the performance is a consequence of two important factors: The first one is related to the directionality in the antennas by itself because as it was previously demonstrated by Chen et al. (2013) the maximum achievable throughput of ad-hoc networks increases as the angle of the antenna beam decreases. The

second factor is related to the redundancy in the routing paths that DXR-AODV offers versus LEOD and AODV which reduces the demand for repair routes (route repair procedures) or start the route discovery process again.

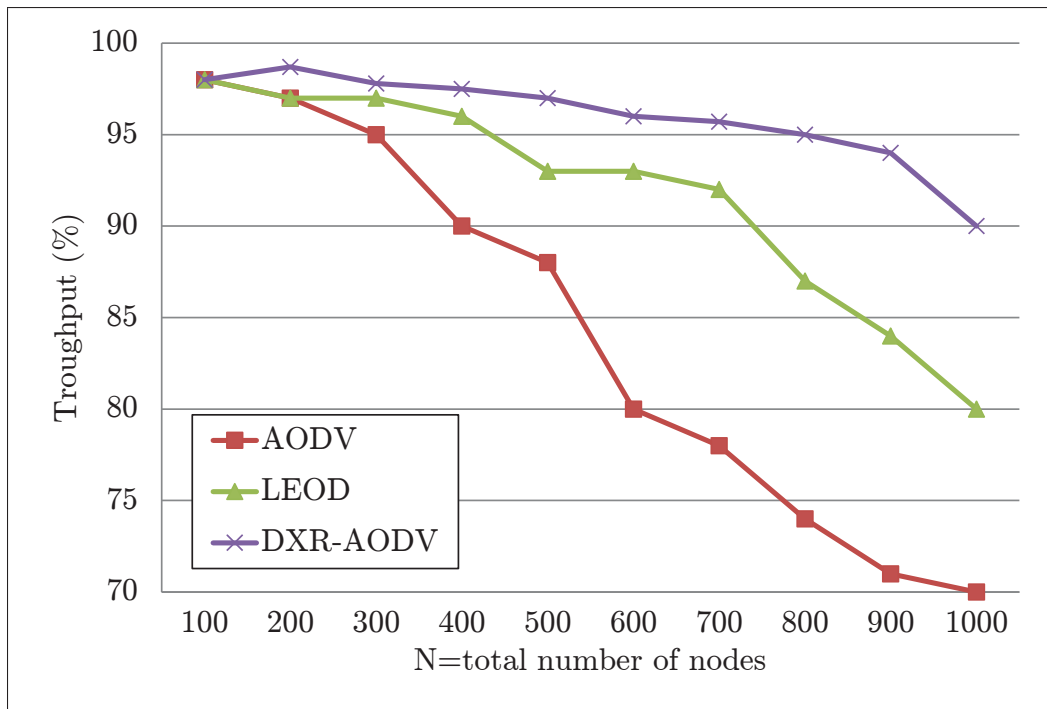

Figure 4.9 Throughput

To summarize, in this chapter we presented a novel gossip neighborhood discovery algorithm that uses the information provided by directional antennas to discover neighbors in the second neighborhood of the node using directional beams. Then, a routing algorithm that aims to reduce the number of hops during the route construction using the information provided by the neighborhood discovery algorithm also proposed in this chapter and we concluded with a comprehensive comparison between the scheme suggested in this article and similar solutions previously developed. Nevertheless, the energy consumption was not evaluated in this chapter, and it can be a good future work to determine the improvements in terms of energy consumption that can be achieved when directional antennas are used in ad-hoc networks.

CHAPTER 5

ENERGY MODEL FOR DIRECTIONAL AD-HOC NETWORKS

5.1 Introduction

As mentioned in previous chapters, ad-hoc networks have an important set of applications in industry, military, personal, sensors and vehicular networks. No matter if the nodes are moving or not, most of this applications require nodes to be powered by batteries or solar panels which are a limited source of energy. Therefore, researchers in the past have given a lot of attention in ad-hoc protocols that consider efficient algorithms to reduce the energy consumption. In the literature review, we identified two methods as the most used ones to evaluate the performance of these protocols: simulation using an appropriate software or through a mathematical model using graph theory. Although both methods have been proven to be efficient, we will focus on the graph theoretical model to give continuity to our work and also because we have identified that there is a lack of consideration of the directionality on the models developed so far. To accomplish this aim, in this chapter we present an overview of the relevant research works done so far, then we introduce a novel model for estimating the energy consumed in MANETs when smart directional antennas are installed on the nodes. Subsequently, we describe the setup assumptions for the model validation, and we finalize the chapter with an analysis of the obtained results and some proposals for future work.

5.2 Proposed Model

This model is based on the model that we have previously developed in Section 3.3. We depart from the same assumption that at any time a wireless ad-hoc network can be represented as a graph $G(V,E)$ where the vertices represent the nodes and the edges represent the energy used to transmit information from one node to other. To estimate the energy consumed, we first will need to determine the connectivity between nodes using the model proposed in section. Then, we construct the graph with all the possible routes between one source node and all other

nodes. After that, the shortest path between source and destination must be determined. Once the paths from all nodes to the given node are calculated, the number of messages transmitted during the session can be determined. Finally, with the number of messages transmitted, the consumed energy can be estimated. In the following sections, we will describe in detail our model.

5.2.1 Node Distribution Model

As in Chapter 3, we consider that nodes are uniformly distributed over a square shaped service area of length M ; therefore, the coverage area is defined as $\Omega = M \times M$ and the node density is defined as $d = \frac{N}{\Omega}$ where N is the total number of nodes.

5.2.2 Network Topology

In real scenarios nodes are positioned on a three dimensional space (x_i, y_i, z_i) but in order to simplify our analysis and following a commonly accepted assumption made in several previous works, we have decided to use a two dimensional array (x_i, y_i) with N columns where N is equal to the number of nodes in the network. The network topology of the area to be studied is then represented as shown on Table 5.1

Table 5.1 Position of the nodes array

ID	1	2	3	...	N
X pos	x_1	x_2	x_3	...	x_N
Y pos	y_1	y_2	y_3	...	y_N

5.2.3 Antenna model

In general terms, an antenna is a device that is capable to radiate or collect radio signals in all directions(omnidirectional case) or in a specific direction(directional case). Traditional wireless networks are equipped with omnidirectional antennas but recently the research community

has pointed out that directional antennas can improve the performance of these networks. A directional antenna can have a larger range compared to an omnidirectional antenna due to its directivity. The antenna gain is used to quantify the directionality of an antenna. For a given direction \vec{d} , the gain of a directional antenna is defined as:

$$G(\vec{d}) = \frac{\eta U(\vec{d})}{U_{avg}} \quad (5.1)$$

Where $U(\vec{d})$ is the power density in the direction of \vec{d} , U_{avg} is the average power density over all directions, and η is a parameter used to define the antenna efficiency that represents the losses related to the hardware design. In this work, we assume that all the nodes in the network are equipped with a switched beamforming antenna array of N elements. The main lobe of each element is represented as a conical segment of $2\pi/N$ radians. For convenience, we assumed that the gain of the side lobes is depreciable. We also assume that the antenna elements do not overlap and cover the entire plane when all of them are used at the same time. We numbered the elements from 1 to N starting with the element located in the east (3 o'clock) position, following the same convention used in Zhou et al. (2007).

5.2.4 Wireless Channel Model

In radio communications, the power transmitted decreases according to the distance traveled to the destination. This fact is called path loss and according to Rappaport, Theodore (2002), it follows a power law that can be represented as:

$$P_a(r) = c \left(\frac{r}{r_0} \right)^{-\eta} \quad (5.2)$$

Where r_0 is a reference distance, the parameter η is commonly referred as the path loss exponent which can take values from two in free space to six in highly dense urban environments.

The constant c depends on the transmitted power, gains of transmitting and receiving antennas, and the wavelength of the signal.

5.2.5 Graph Representation Matrix

In real scenarios nodes are positioned on a three dimensional space (x_i, y_i, z_i) but in order to simplify our analysis and following the same assumption made in Section 3.3.2 we use a two dimensional array (x_i, y_i) with N columns where N is equal to the number of nodes in the network. The network topology to be studied is shown on Figure 5.1.

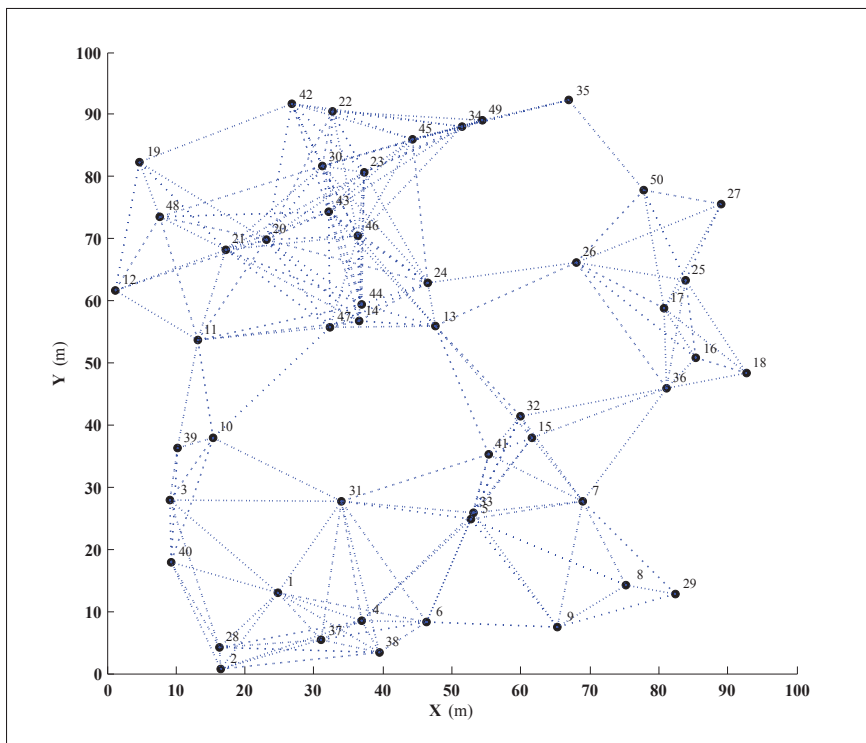

Figure 5.1 Node distribution and connectivity

5.2.6 Routing scheme

The routing process in ad-hoc networks can be performed in advance (proactive routing) or on-demand (reactive routing). In this study, we consider a reactive approach like AODV to keep

coherence with the first stages of this thesis. In a reactive scheme, the route is calculated step by step and the next hop of the route is selected considering a given or desired parameter such as hop count, link quality, residual energy among others. Therefore, the route with less cost in terms of the desired parameter is chosen as the best route. For this reason, the shortest path algorithm is commonly used in this mechanisms. From the literature review, we observed that the Dijkstra algorithm is the most used approach which is a single-source shortest path algorithm. However, the weight of all the edges must be non-negative or in other words, Dijkstra is not able to detect loops in the route. As we experienced loop issues during the simulations in the first stage of our research, we investigated the alternatives to Dijkstra and we found that the Bellman-Ford algorithm is also a single-source shortest path algorithm, similar to Dijkstra but it allows for negative edge weights and it can detect loops in a graph. The Bellman-Ford algorithm is implemented into the `graphshortestpath` function that comes in the Network Analysis and Visualization class of the Bioinformatics toolbox of MATLAB(MathWorks (2012)):

$$[distSP, path, pred] = graphshortestpath(G, S, D, method, Bellman - Ford)$$

The `graphshortestpath` function determines the single-source shortest paths from nodes S to D in the graph represented by matrix G . As inputs, this function requires G which is an N-by-N sparse matrix that represents a graph. Nonzero entries in matrix G represent the weights of the edges. $distSP$ are the N distances from the source to the destination node. pat contains the winning path. $pred$ contains the predecessor nodes of the winning path. Figure 5.2 shows a sequence (from a to d) of messages sent from node 25 to every other node in the network and the corresponding routing path established (nodes 5 to 8 in the example).

The matrix G is constructed based on the network topology array in the following way: Using the function described in algorithm 3.1, we go over the array which represents the network. On each iteration, the Euclidean distance between each pair of nodes is calculated. Then, this distance is normalized and the connection between any two nodes is determined based on the directional link probability. If $p(\hat{r}_{ij}) = Pr [10\log_{10}\hat{P}(\hat{r}_{ij}) > 0]$ a link between i and j is drawn.

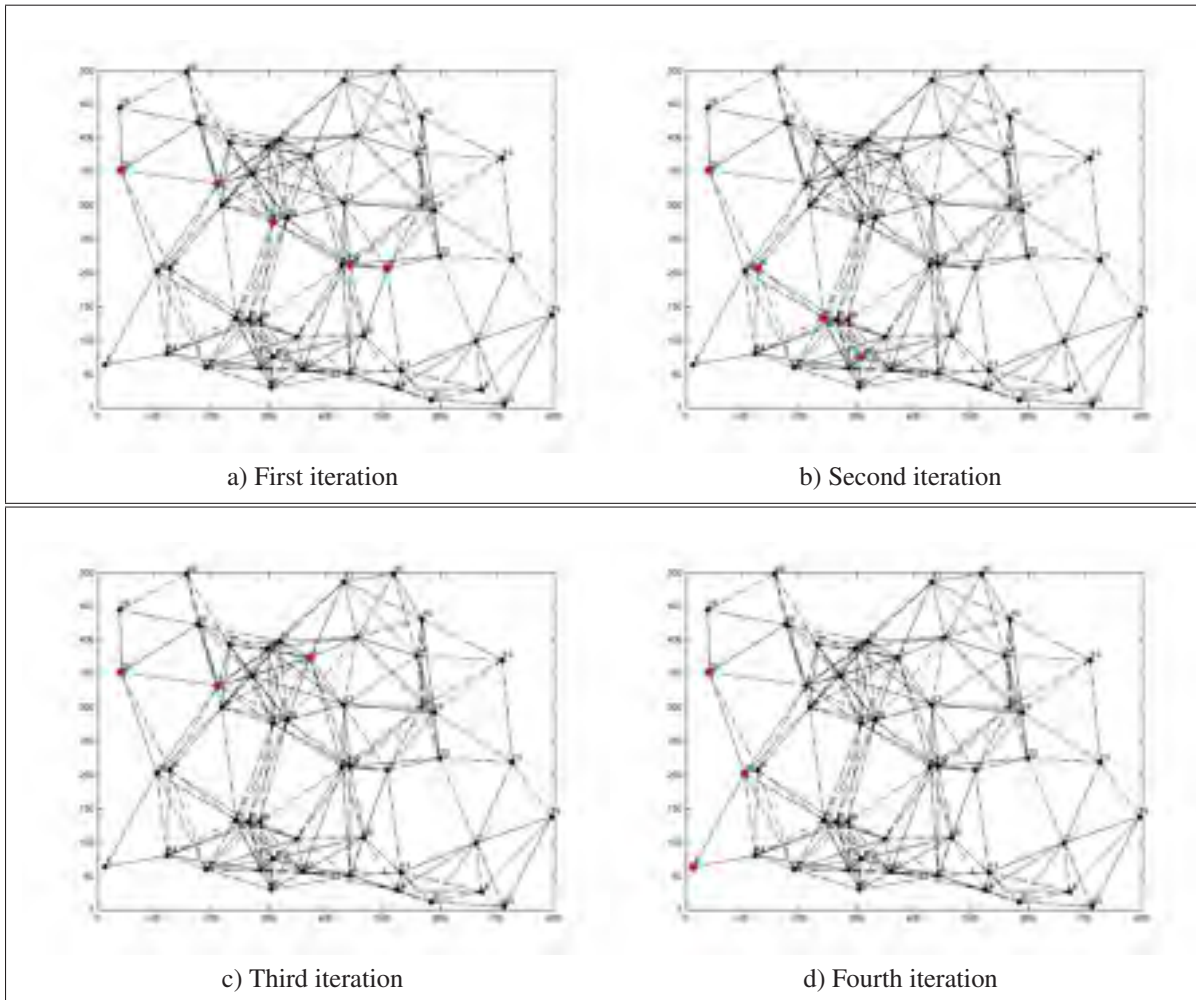

Figure 5.2 Several iterations from node 25

5.3 Energy Cost of Communication

Once the paths from the source node (number 25 in the example) to every other node in the network are calculated, the number of messages exchanged during the communication can be estimated. To illustrate this fact, let's consider the set of five nodes in Figure 5.3 where node n_1 starts the route discovery and tries to deliver a message to n_5 . In this case, we have one source node, one destination node, and three intermediate nodes.

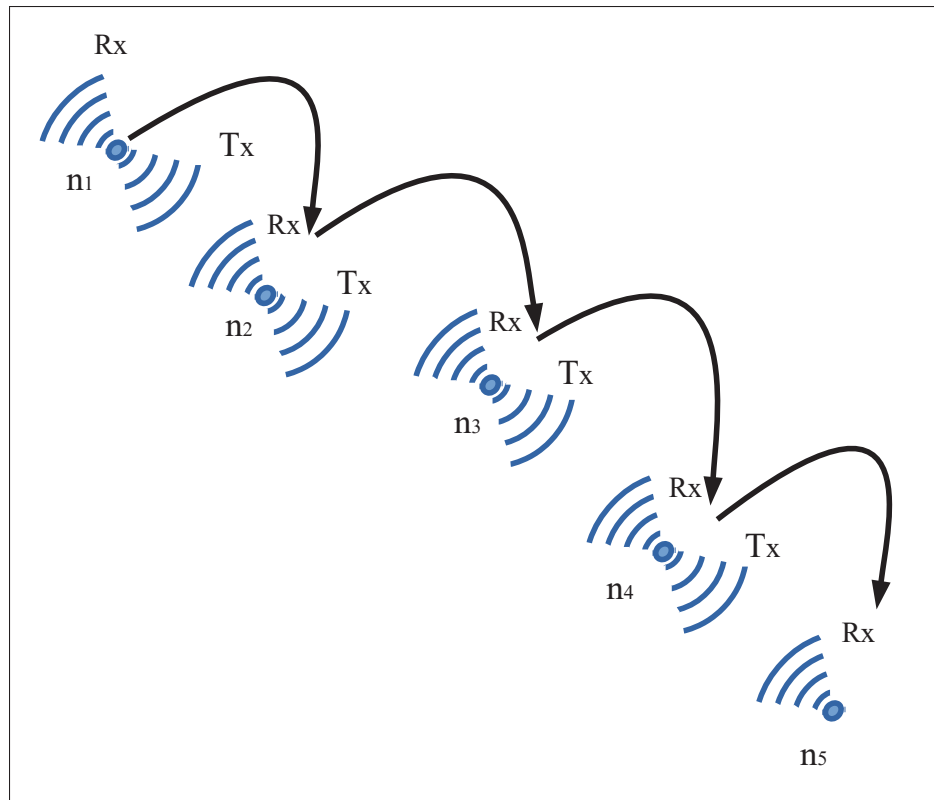

Figure 5.3 Unicast cost with omnidirectional antennas

5.3.1 Omnidirectional Energy Cost

Let's first consider that all the nodes only have omnidirectional antennas. Node 1 propagates a message so node 2 receives the message, checks the routing header and checks the cyclic redundancy (CRC) and then sends the message downstream but due to the omnidirectional nature of the network, node 1 receives back from node 2 a copy of the propagated message with a different destination address. As it does not correspond to it, the message is discarded but it was overhead by n_1 . This fact is called the overhead message and it was widely investigated by Basu and Redi (2004).

For the simulation, we considered a store-and-forward procedure where every message is received then read it. If the message is destined for the given node it is processed otherwise it is discarded. This last statement means that even if a message is not destined to a given node, the node uses energy to receive and process the message. For simplicity, we also assume that

the energy consumed by the overhead E_{OH} is equal to the energy required for reception E_{RX} . Therefore the node that starts the route discovery n_1 consumes E_1 .

$$\begin{aligned} E_1 &= E_{TX} + E_{OH} \\ E_1 &= E_{TX} + E_{RX} \end{aligned} \tag{5.3}$$

The intermediate nodes consumes E_{RX} when receiving the forwarded message plus the energy required for re-transmit the message downstream E_{TX} , finally they overhead the message sent back by the downstream node so they consumes in addition E_{OH} . Hence, the energy consumed by relaying nodes E_{rel} is:

$$\begin{aligned} E_{rel} &= E_{TX} + E_{RX} + E_{OH} \\ &= E_{TX} + 2E_{RX} \end{aligned} \tag{5.4}$$

The next aspect to consider is the energy consumed by broadcasting. In terms of reactive protocols such as AODV, this energy is a representation of the messages used to discover the neighbor nodes of a given node. The effect of HELLO messages in AODV was studied in Bhanushali et al. (2015) while the energy consumed by broadcasting in ad-hoc networks was extensively modeled by Wieselthier et al. (2000).

From this last research work, we adopt the Wireless Multicast Advantage (WMA) model. WMA is used to describe the energy cost of the rebroadcasted message, and to illustrate this fact we use the Figure 5.3. In the figure, N_i broadcast a message that is heard by all the neighbor nodes in the range of N_i . Consequently, all the nodes within the range of N_i will respond to the broadcast message and N_i spent energy listening to the responses. Thus, we can state that the energy cost of the broadcasted message is affected by the presence of the neighbors

of the broadcasting node. This means that for every message that node i receives and rebroadcast it consumes $E_{TX} + E_{RX}$ plus the energy required to overhear the acknowledgment from its neighbors. Therefore, the total energy consumed is given by equation 5.5:

$$E_i = E_{RX} + E_{TX} + (m_i - 1)E_{RX} \quad (5.5)$$

Where $(m_i - 1)$ represents the fact that the message broadcasted is overhead by node i from all the nodes $m \in M_i$ that surround the node except the node that sends the broadcast message. This model was used in many relevant works such as Singh and Raghavendra (1998) and Wieselthier et al. (2000).

Finally, to calculate the cost of the messages transmitted during the communication process, it is necessary to count the messages transmitted, received and overhead. This is performed on each iteration during the simulation time. As it was proposed by Wieselthier et al. (2000), we use the matrix TxRxOx to count the messages as it is shown in table 5.2.

Table 5.2 Number of messages matrix

ID	1	2	3	...	N
Rx	8	23	48	...	73
Tx	2	36	53	...	42
Ox	12	4	2	...	26
Total	22	63	103	...	141

5.3.2 Proposed Solution: Directional Energy Cost

In the past section, we presented an energy cost model developed by previous researchers that consider omnidirectional transmissions. In order to contribute to this important field of the telecommunications industry, we propose to consider directional transmissions in the energy cost model for ad-hoc networks. To illustrate our model, consider the Figure 5.4, where the

node n_1 initiates a route discovery to deliver a message to n_5 . Assuming that the nodes implement the neighbor discovery protocol that we previously developed in Section 4.2.1, it is possible for n_1 and n_3 to reduce the number of hops by knowing that they can reach n_3 and n_5 respectively using directional links instead of omnidirectional beamforming.

To reach these further nodes, our model does not consider to increase the power of the transmitters, therefore the energy required for transmitting remains as constant and equal to E_{TX} . The energy used for reception in our model is the same as in the omnidirectional case because we have assumed omnidirectional reception in any case.

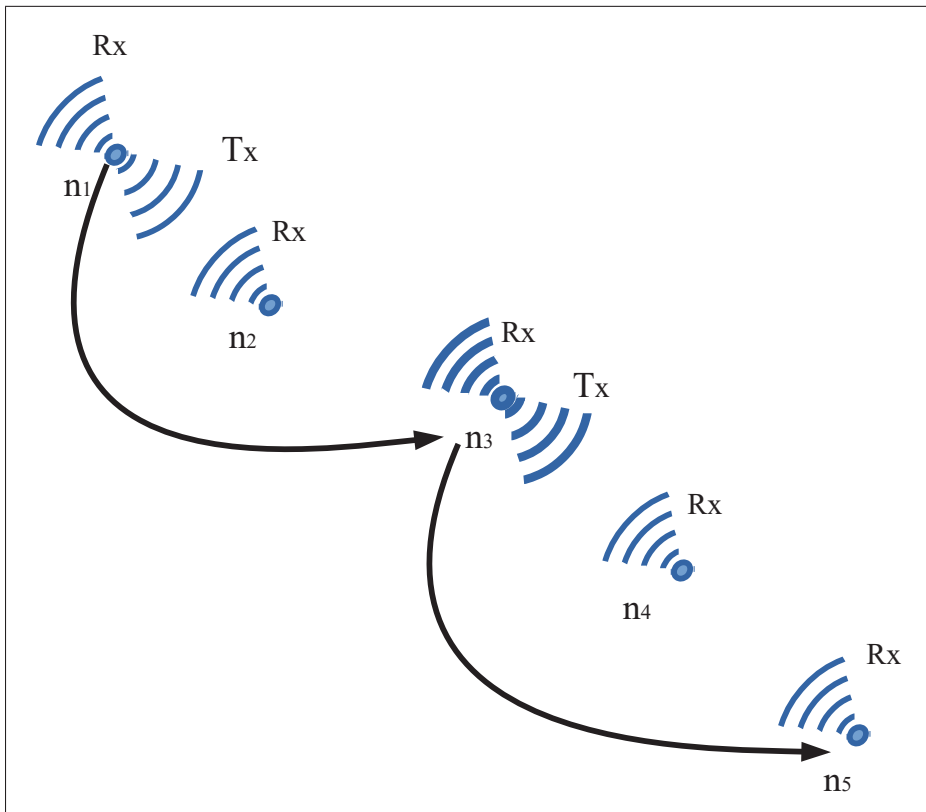

Figure 5.4 Unicast cost with directional antennas

Therefore the node that starts the route discovery (n_1) consumes E_1 :

$$E_1 = E_{TX} + E_{RX} \quad (5.6)$$

Then, the intermediate node or relay node consumes energy when receiving the route discovery message(E_{RX}), then it retransmits the message downstream but instead of transmitting it omnidirectionally, intermediate nodes transmits directionally to the next hop. If the node knows about distant nodes that can be reached using longer beams, the node will try to reach them. As we assume that distant nodes can be reached by narrowing the beams instead of increasing the transmission power, the Energy used for transmissions is constant and equal to E_{TX} . Hence, the energy consumed to move downstream a message is as presented in Equation 5.7:

$$E_{rel} = E_{TX} + E_{RX} \quad (5.7)$$

For the broadcasting cost, we assume that the node sends the broadcast messages omnidirectionally by setting the antenna elements heights to the same value so the energy consumed is equivalent to the omnidirectional case as is presented in Equation 5.8:

$$E_i = E_{RX} + E_{TX} + (m_i - 1)E_{RX} \quad (5.8)$$

Finally, we calculate the total cost of communication by adding the cost of unicasted and broadcasted messages:

$$E_{unicast} = E_{unicast} + E_{broadcast} \quad (5.9)$$

Where the energy consumed when unicasting is:

$$E_{unicast} = E_1 + \sum_{n=1}^{M_i} E_{rel} + E_{dest} \quad (5.10)$$

and the energy consumed when broadcasting is:

$$\begin{aligned} E_{broadcast} &= \sum E_i \\ &= E_{TX} + m_i E_{RX} \end{aligned} \quad (5.11)$$

Counting the number of messages transmitted, received and overheard can be performed during the path discovery processes. In our implementation, we count the messages transmitted, received and overhead using the RxTxOx matrix (see Table 5.2). On each iteration, the number of messages is counted and then saved on the matrix. Once the paths are established and the number of messages is counted, we proceed to calculate the total energy consumed as we detail in the next section.

5.4 Energy model for messages transmitted

In this section, we propose an energy model that estimates the energy consumed by an ad-hoc wireless network. We based our model on the assumption that the total energy that every node spend is directly proportional to the time that each node stays in sleep, idle, transmission and reception mode. This assumption was also used in previous models, such as Simek and Moravek (2011).

The first step during the modeling process was to study the IEEE 802.11 specification (IEEE (2012)) and determine the time required for every process that leads to a successful message transmission. Then, the energy consumption of the communication modes can be obtained from the chipset data sheets. For our model, we searched for a widely used transceiver chip. We use the information of the Microchip MRF24GWG0MA RF transceiver (Microchip (2016)). According to the data sheet, it consumes 0.1 mA in sleep mode, 4 mA in idle mode, 156 mA when receiving and 240 mA when transmitting. Finally, with the information obtained in the previous steps and assuming the successful transmission of a data packet, the energy consumed per message transmitted, received and overheard can be estimated.

The Figure 5.5 help us to describe the time required for a successful transmission/reception of a message on IEEE 802.11b. Let's begin stating that the IEEE 802.11 DCF (Distributed Coordination Function) uses the Carrier Sense Multiple Access/Collision Avoidance (CSMA/CA) access method, that without loss of generality can be resumed as follows:

A station trying to transmit first checks if the channel is free then waits for the DIFS interval (Distributed Inter Frame Space) and then transmits if the medium is still free. The receiving station sends an ACK frame after the SIFS interval (Short Inter Frame Space) if the frame is correctly received. When the station senses the channel busy, it waits until it is free and after the DIFS interval, it chooses random backoff b , an integer uniformly distributed in the contention window $[0, CW]$ ($CW_{min} = 31$ for 802.11b) and counts down for b SLOT intervals before attempting to transmit. If another station transmits before the end of the backoff, the count down freezes and the remaining time is used in the next transmission attempt. If two stations have the same values of the backoff (or the remaining backoff), they transmit at the same instant and collide. A station can detect a collision because it does not receive an ACK for its frame. In this case, it applies the exponential backoff algorithm (it doubles CW up to the maximal value of CW_{max}). CW returns to the minimal value of CW_{min} after a successful transmission (Duda (2008)).

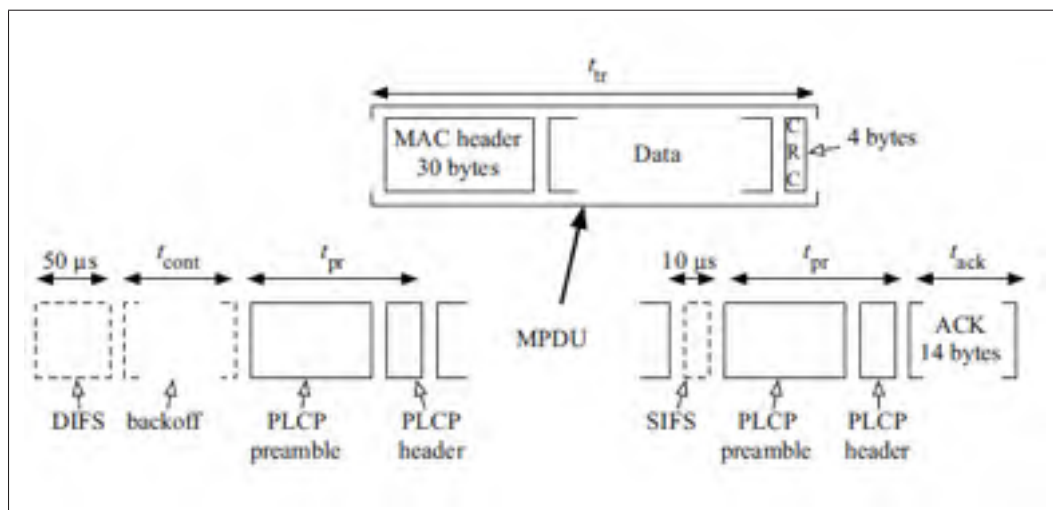

Figure 5.5 Successful frame transmission under 802.11b

Therefore, to estimate the total time required for a successful transmission we use the information about the time needed for each interval that we obtained from the IEEE 802.11 specification. This information is resumed in the table 5.3.

Table 5.3 IEEE 802.11 MAC and PHY parameters

variant	bit rate (Mb/s)	DIFS	SIFS	SLOT	t_{pr} μ s
802.11b	1, 2, 5.5, 11	28 μ s	10 μ s	20 μ s	192, 96
802.11g	6, 9, 18, 24, 28, 36, 48, 54	28 μ s	10 μ s	9 μ s	22.1

To calculate the total time required to successfully transmit a message we made some assumptions and follow the sequence described below:

- The nodes communicate with each other using the TCP protocol;
- Assume that each TCP data packet is followed by a TCP ACK packet;
- To transfer the data segment there will be silence during at least one DIFS slot, signaling that the medium is available. More than one if the node is executing back-off;
- The data frame containing the TCP data;
- A SIFS gap between data frame and 802.11 ACK frame;
- The 802.11 ACK frame.

Then, to transfer the TCP ACK packet:

- There will be a silence during at least one DIFS slot, signaling that the medium is available. More than one if the node is executing back-off;
- The data frame containing the TCP ACK;
- A SIFS gap between data frame and 802.11 ACK frame;

- A 802.11 ACK frame

In addition to the payload data, the data frame has additional 36 bytes of data, out of those 28 bytes are 802.11 MAC header for various inherent functions such as control and management, error detection and addressing. The other 8 bytes are a header to identify the network layer protocol.

To transfer 1460 bytes of payload in 802.11b at 11 Mb/s, we have a packet with 1500 bytes of data including the TCP/IP headers, and 1536 bytes if we consider the MAC header. For the TCP ACK packet of 40 bytes there is also an additional 36 bytes for MAC header, so total 76 bytes for the TCP ACK.

The 802.11 ACK frame has a length of 14 bytes. We neglect media contention and retransmissions. At 11 Mb/s the data rate is 1.375 Msymbols/s, where each symbol is 8 bits. Thus the time required to transmit a data packet can be calculated by the equation:

$$\begin{aligned}
 t_{TX} &= DIFS + t_{pr} + t_{tr} + SIFS + t_{pr} + t_{ACK} & (5.12) \\
 &= 50\mu s + 192\mu s + 1536/1.375 + 10\mu s + 192\mu s + 14/1375 \\
 &= 1573\mu s
 \end{aligned}$$

In the same way, the time required to transmit a TCP ACK packet can be estimated. In this case, the t_{tr} is calculated using the size of the TCP ACK message (76 bytes), as we present here. In total we need 2084 μ s to transmit 1460 bytes of payload:

$$\begin{aligned}
 t_{ACK} &= DIFS + t_{pr} + t_{tr} + SIFS + t_{pr} + t_{ACK} & (5.13) \\
 &= 50\mu s + 192\mu s + 76/1.375 + 10\mu s + 192\mu s + 14/1375 \\
 &= 511\mu s
 \end{aligned}$$

Following the same procedure present before, we can calculate the time needed to receive a message:

$$\begin{aligned}
 t_{RX} &= DIFS + t_{pr} + t_{tr} + 2 \times SIFS + t_{ACK} \\
 &= 50\mu s + 192\mu s + 1536/1.375 + 20\mu s + 14/1375 \\
 &= 1389\mu s
 \end{aligned}
 \tag{5.14}$$

Once the time spent in both active status (transmission and reception) is determined, we can estimate the energy consumed per node on each computed route to the destination. To do so, we need the voltage and current that the chipset uses on each status, table 5.4 presents this information. As illustration, we calculate the energy dissipated by the sender node, (n_1 in Figure 5.4):

$$\begin{aligned}
 E_1 &= V \times I \times t \\
 &= 3.3[V] \times 240[mA] \times 1.5[ms] \\
 &= 1.18[mJ]
 \end{aligned}
 \tag{5.15}$$

In the same way, the energy dissipated for every node in the route can be calculated. For a more precise result, the power can be measured in real devices, in this research work we just presented a simplified calculation.

Table 5.4 MRF24WG0MA/MB Parameters

Mode	Current	Voltage
RX	156 mA (typical)	3.3 V (typical)
TX	240 mA (typical)	3.3 V (typical)
Idle	4 mA (typical)	3.3 V (typical)
Sleep	0.1 mA (typical)	3.3 V (typical)

5.5 Simulation Setup

The proposed model was implemented in MATLAB (MathWorks (2012)) environment. We have configured three scenarios with different numbers of nodes $N=50,100$ and 500 . In each case, Nodes were randomly placed over a square shaped area of $800 \times 500\text{m}$. For mobility, the random waypoint model (RWP) was implemented with a minimum velocity of 5m/s and a maximum of 10m/s and a pause time of 5s . A single node (25) was selected as the network gateway, so in every round, all the nodes tried to send a message to node 25 through a multi-hop path of relaying nodes.

The simulation time was set to 100 seconds. During the simulation, the number of messages transmitted, received and overheard by each node is computed and stored in the RxTxOx matrix. For example, figure 5.6 shows a bar graph with the number of messages transmitted per node. At the end of the simulation the energy consumed by the entire network is calculated and stored in the total energy (ET) matrix, and the average energy consumed by the whole network is stored in the average energy matrix (AE).

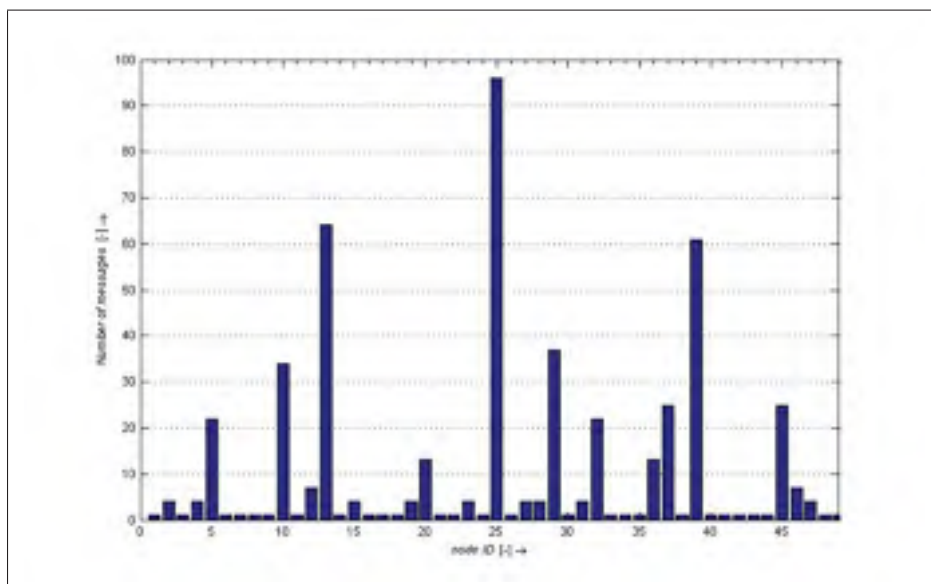

Figure 5.6 Number of transmitted messages per node

5.6 Results Analysis

In this section, we present the results obtained through the simulation described in section 5.5. The first scenario was setup with 50 nodes uniformly distributed in a $500m \times 800m$ area, we run the same script 100 times, and we take the average. Figure 5.7 shows the total energy consumed by the ad-hoc network when omnidirectional antennas (blue line) and directional antennas (orange line) are used. Red and green dotted lines represent the average energy consumed in each case respectively. As we can see in figure 5.7, the average energy consumed by the 50 nodes network when using directional antennas is 35% more efficient than when using omnidirectional antennas.

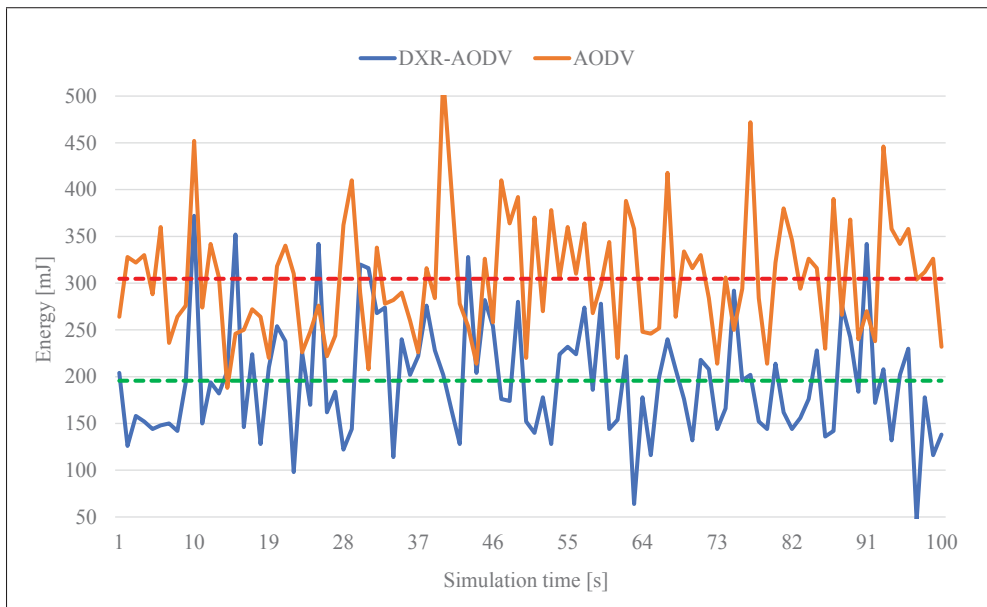

Figure 5.7 Total Energy Consumed: 50 Nodes scenario

Figures 5.8 shows the results obtained when the number of the antennas increases to 100 and nodes assuming the same coverage area as in the previous experiment ($500m \times 800m$). In this case, we observed that the average energy consumed by the network when using directional antennas is 18% more efficient than when using omnidirectional antennas. Although there is still an improvement in the energy consumption, we observed that this contribution is lower than the case with just 50 nodes. This fact is a consequence of the increased network density

because of the more the nodes in the network, the higher the total amount of traffic each node generates.

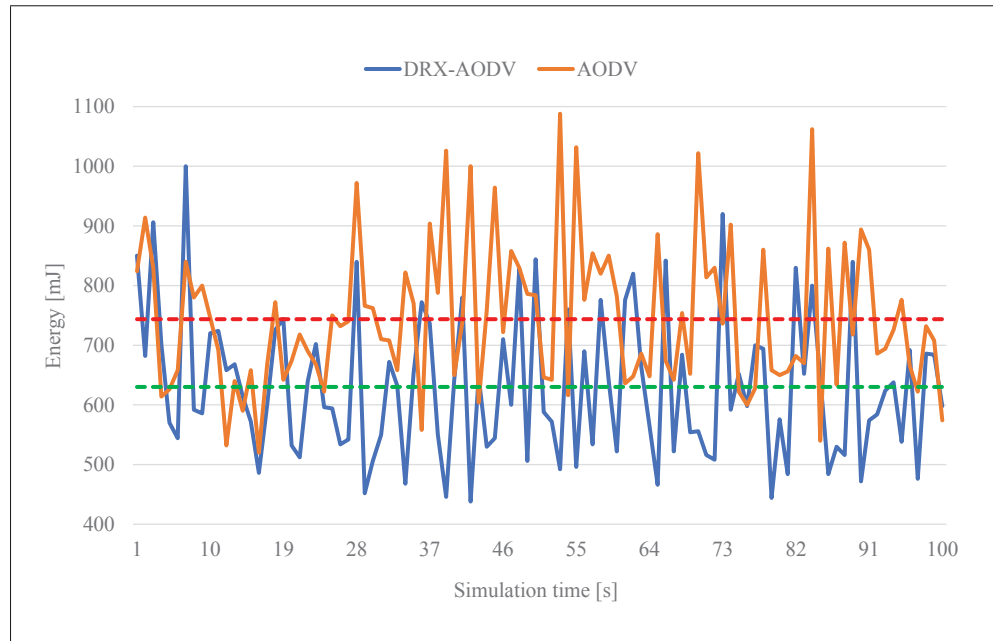

Figure 5.8 Total Energy Consumed: 100 Nodes scenario

Consequently, more traffic is going over the network per time unit and energy is depleted more quickly. This is a critical remark because the energy saving that a protocol can contribute to saving can not be infinite and as was previously demonstrated by the fundamental research done by Spyropoulos and Raghavendra (2002) there is a boundary in the energy that can be saved with directional antennas in ad-hoc networks.

As consequence of the results of the last experiment, we wanted to determine the number of nodes where both solutions (directional and omnidirectional) perform similarly. We define a scenario with 500 nodes uniformly distributed in a $500m \times 800m$ area, we run the same script 100 times, and we take the average. Figure 5.9 shows the results of this simulation. We can observe that the average energy consumed by the network when using directional antennas is just 1.25% more efficient than when using omnidirectional antennas. We considered that at this

point both methods work equally so for more than 500 nodes there is no difference regarding energy consumption to use any of them.

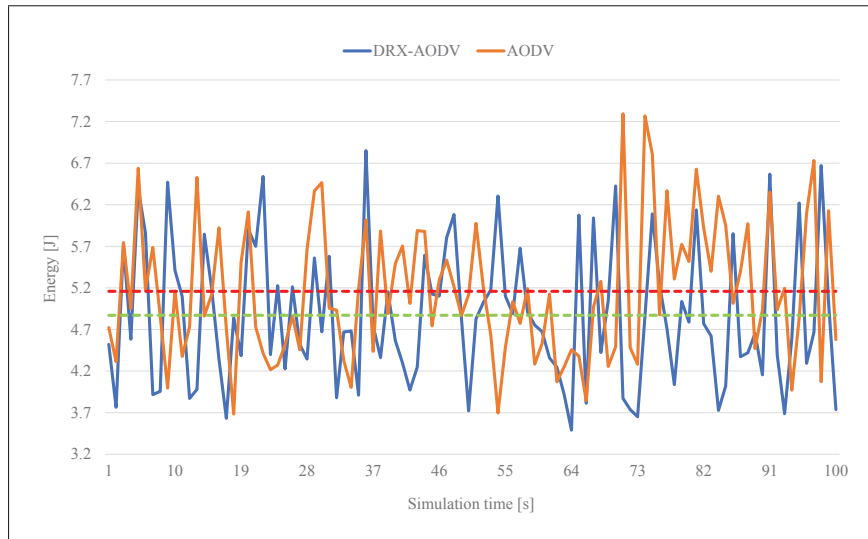

Figure 5.9 Total Energy Consumed: 500 Nodes scenario

To summarize, in this chapter we presented an energy model based on graph theory that considers the energy dissipated by smart directional antennas. We have demonstrated that there are important reductions in the energy consumed in ad-hoc networks when using directional antennas that in the best case can save up to 35% of the total energy. Nevertheless, we conclude that as the number of the nodes increases from 50 to 500 the improvement in energy savings as consequence of the use of directional antennas experience a reduction.

Although our proposed solution performs better than AODV when the number of nodes is relatively smaller, we noticed a decrease in the energy that can be saved when using directional antennas as the number of the nodes increases. This event can be explained as consequence of the increased node density in the network. Even if we are reducing the path lengths between nodes, the fact that there are more nodes in the network implies more traffic to be generated. The more the nodes in the network, the higher the total amount of traffic each node generates. Consequently, more traffic is going over the network per time unit and energy is depleted more quickly.

CONCLUSION AND RECOMMENDATIONS

The use of smart directional antennas in ad-hoc wireless networks has been an active research topic in the last decade. Most of the previous work has been focused on adapting the existing MAC protocols to support directional antennas or make an efficient spectral reuse to obtain a higher feasible bandwidth. In this thesis, we investigated the impact of directional antennas in the neighbor discovery process and the routing protocols concerning network performance as well as energy consumption.

This research work first developed a model for wireless ad-hoc networks with directional antennas using a graph theoretical approach. We proposed an innovative link probability model that considers the directional gain of the smart antenna array. Through simulations, we demonstrated that it is possible to achieve a higher network connectivity when directional antennas are considered in the model. We also observed that as the main lobe of the antenna array is narrowed and consequently the antenna range is extended, the probability to have a link with nodes that are farthest is higher if it is compared to the omnidirectional model.

Hop count is an important metric in wireless ad-hoc networks because every hop in the route implies an increase in the delay between source and destination due to message processing on the relaying nodes, propagation, and signaling. Regarding the hop count, we have also noticed a reduction in the mean hop count when the directional model is used. Fewer hops in any path between a source and destination node are considered as an improvement in network performance because of more hops in a route necessary lead to a higher transmission delay.

This thesis also studied the neighborhood discovery and routing protocol issues in wireless ad-hoc networks when smart directional antennas are included in the system. The aim at this stage of the thesis was to reduce the number of hops between source and destination nodes. As a solution, we have proposed DXR-AODV protocol which is an enhancement of the traditional AODV protocol. From the simulations performed in this research work, we concluded that our

scheme outperforms AODV and LEOD protocols concerning end-to-end delay, throughput, and packet loss when they are compared in the scenarios described in this thesis.

The energy consumption was also evaluated in this thesis. We analyzed the impact of the reduction in the number of hops in a route in terms of the energy consumed by the entire network. To do this analysis, it was necessary to model the relationship between the use of the extended range antenna and the power consumption. Through simulations, we have proved that in the best scenario, directional antennas can provide up to 35% of energy savings when compared to omnidirectional antennas.

Future Work

This research work addressed the impact of smart directional antennas in ad-hoc networks taking into account the improvements regarding performance and energy consumption that can be achieved in the neighborhood discovery and routing schemes when the smart antennas are used. Some perspectives for the continuation of this thesis are listed below:

- This thesis assumed some ideal conditions to reduce the complexity of the analysis. For example, the main lobe of the antennas was assumed as a conical shape projected over the X-Y plane and that the side lobes do not interfere with the main lobe of the antenna. It will be interesting to consider a three-dimensional model as well as the interference of the sidelobes to analyze the impact of these two factors in the performance and energy consumption of the ad-hoc network;
- During the development of this thesis a fundamental, pure ad-hoc network was assumed in the models. It will also be interesting to apply the results of this work to a particular application or scenario such as a Disaster Recovery network, Military or Public Security Network;

- Finally, the models proposed in this thesis were evaluated over a simulated environment which is a good representation of the reality, but we consider that it will be interesting to run the solutions proposed in a real scenario such as a testbed with real nodes and antennas. As an example, we can cite the Project IoT-Lab (European Commission, 2016) where a network with real mobile sensors can be used to test innovative developments in the ad-hoc, IoT and sensors networks.

APPENDIX I

LIST OF PUBLICATIONS

Journals:

- J-1 Astudillo, G. & Kadoch, M. 2016. Neighbor discovery and routing schemes for mobile ad-hoc networks with beamwidth adaptive smart antennas. *Telecommunication Systems*, 4, 5280-5292, Springer Verlag. doi: 10.1007/s11235-016-0268-x.
- J-2 Astudillo, G. & Kadoch, M. 2017. A Realistic Energy Model for Wireless Ad-hoc Networks with Smart Directional Antennas. Article submitted to *Ad-Hoc Networks*, Elsevier.

Conferences:

- C-1 Astudillo, G. & Kadoch, M. 2014. A Location-aware Routing Scheme for Wireless Mesh Networks using Directional Antennas. *Recent Advances in Computer Engineering, Communications and Information Technology*, 1, 57-62.
- C-2 Astudillo, G. & Kadoch, M. 2015. Impact of Directional Antennas on Link Probability and Connectivity in Wireless Ad-Hoc Networks. *2015 3rd International Conference on Future Internet of Things and Cloud*, 1, 218-224. doi: 10.1109/FiCloud.2015.60.

BIBLIOGRAPHY

- Abolhasan, M., T. Wysocki, and E. Dutkiewicz. 2004. "A review of routing protocols for mobile ad hoc networks". *Ad Hoc Networks* 2(1), 1–22.
- Almeida, N., M. Fernandes, and A. Neto. 2015. "Beamforming and Power Control in Sensor Arrays Using Reinforcement Learning". *Sensors* 15(3), 6668–6687.
- Alshabtat, A., L. Dong, J. Li, and F. Yang. 2010. "Low latency routing algorithm for unmanned aerial vehicles ad-hoc networks". *International Journal of Electrical, Computer, Energetic, Electronic and Communication Engineering* 6(1), 48–54.
- An, X. and R. Hekmat. 2007. "Self-Adaptive Neighbor Discovery in Ad Hoc Networks with Directional Antennas". In *2007 16th IST Mobile and Wireless Communications Summit*, pp. 1–5. IEEE.
- Anastasi, G., M. Conti, and E. G. Laurea. 2005. "IEEE 802.11 Ad Hoc Networks: Protocols, Performance and Open Issues". *Mobile Ad Hoc Networking* 1(1), 69–116.
- Aschner, R., M. J. Katz, and G. Morgenstern. 2013. "Symmetric connectivity with directional antennas". *Computational Geometry: Theory and Applications* 46(9), 1017–1026.
- Astudillo, G. and M. Kadoch. 2015. "Impact of Directional Antennas on Link Probability and Connectivity in Wireless Ad-Hoc Networks". In *2015 3rd International Conference on Future Internet of Things and Cloud*, pp. 218–224. IEEE.
- Astudillo, G. and M. Kadoch. 2017. "Neighbor discovery and routing schemes for mobile ad-hoc networks with beamwidth adaptive smart antennas". *Telecommunication Systems* 1(1), 1–11.
- Basagni, S., I. Chlamtac, V. R. Syrotiuk, and B. a. Woodward. 1998. "A distance routing effect algorithm for mobility (DREAM)". In *Proceedings of the 4th annual ACM/IEEE international conference on Mobile computing and networking MobiCom 98*, pp. 76–84. IEEE.
- Basu, P. and J. Redi. 2004. "Effect of overhearing transmissions on energy efficiency in dense sensor networks". In *Proceedings of the third international symposium on Information processing in sensor networks - IPSN'04*, New York, New York, USA, pp. 196–202. ACM Press.
- Bettstetter, C.. 2002. "On the Minimum Node Degree and Connectivity of a Wireless Multihop Network". In *Proceedings MOBIHOC'07*, pp. 80–91. ACM.
- Bettstetter, C.. 2004. "On the Connectivity of Ad Hoc Networks". *The Computer Journal* 47(4), 432–447.

- Bettstetter, C. and C. Hartmann. 2005. "Connectivity of wireless multihop networks in a shadow fading environment". *Wireless Networks* 11(5), 571–579.
- Bettstetter, C., G. Resta, and P. Santi. 2003. "The node distribution of the random waypoint mobility model for wireless ad hoc networks". *IEEE Transactions on Mobile Computing* 2(3), 257–269.
- Bhanushali, N., P. Thakkar, and P. Shete. 2015. "Impact of Hello Interval on Performance of AODV Protocol". *International Journal of Computer Applications* 116(23), 33–37.
- Broch, J., D. a. Maltz, D. B. Johnson, Y. C. Hu, and J. Jetcheva. 1998. "A performance comparison of multi-hop wireless ad hoc network routing protocols". In *Proceedings of the 4th annual ACM/IEEE international conference on Mobile computing and networking*, pp. 85–97. ACM.
- Cai, H., B. Liu, L. Gui, and M.-Y. Wu. 2012. "Neighbor discovery algorithms in wireless networks using directional antennas". In *Communications (ICC), 2012 IEEE International Conference on*, pp. 767–772. IEEE.
- Camp, T., J. Boleng, and V. Davies. 2002. "A survey of mobility models for ad hoc network research". *Wireless Communications and Mobile Computing* 2(5), 483–502.
- Čapkun, S., M. Hamdi, and J.-P. Hubaux. 2002. "GPS-free positioning in mobile ad hoc networks". *Cluster Computing* 5(2), 157–167.
- Capone, A., F. Martignon, and L. Fratta. 2008. "Directional MAC and routing schemes for power controlled Wireless Mesh Networks with adaptive antennas". *Ad Hoc Networks* 6(6), 936–952.
- Chandra, K., R. V. Prasad, I. G. M. M. Niemegeers, and A. R. Biswas. 2014. "Adaptive beamwidth selection for contention based access periods in millimeter wave WLANs". In *2014 IEEE 11th Consumer Communications and Networking Conference (CCNC)*, pp. 458–464. IEEE.
- Chaqfeh, M. and A. Lakas. 2016. "A novel approach for scalable multi-hop data dissemination in vehicular ad hoc networks". *Ad Hoc Networks* 37, 228–239.
- Chen, K. and F. Jiang. 2007. "A range-adaptive directional MAC protocol for wireless ad hoc networks with smart antennas". *AEU - International Journal of Electronics and Communications* 61(10), 645–656.
- Chen, Y., J. Liu, X. Jiang, and O. Takahashi. 2013. Throughput analysis in mobile ad hoc networks with directional antennas. *Ad Hoc Networks* 11(3), 1122–1135.
- Cheng, B.-N., M. Yuksel, and S. Kalyanaraman. 2010. Using directionality in mobile routing. *Wireless Networks* 16(7), 2065–2086.

- Choudhury, R. R., X. Yang, N. H. Vaidya, and R. Ramanathan. 2002. Using directional antennas for medium access control in ad hoc networks. In *Proceedings of the 8th annual international conference on Mobile computing and networking - MobiCom '02*, pp. 59–64. ACM.
- Clausen, T. and G. Hansen. 2001. The optimized link state routing protocol, evaluation through experiments and simulation. In *IEEE Symposium on Wireless Personal Mobile Communications*, Address, pp. 5–10. IEEE.
- Cobo, L., H. Castro, and A. Quintero. 2015. "A location routing protocol based on smart antennas for wireless sensor networks". *Indian Journal of Science and Technology* 8(11).
- Cullen, A.. 1982. *Microstrip Antenna Theory and Design* (3 ed.), Volume 28. John Wiley & Sons.
- Dai, F., Q. Dai, and J. Wu. 2005. Power efficient routing trees for ad hoc wireless networks using directional antenna. *Ad Hoc Networks* 3(5), 621–628.
- Dai, H.-N. and Q. Zhao. 2015. On the delay reduction of wireless ad hoc networks with directional antennas. *Eurasip Journal on Wireless Communications and Networking* 2015(1), 1–13.
- Daly, E. M. and M. Haahr. 2009. Social network analysis for information flow in disconnected delay-tolerant MANETs. *IEEE Transactions on Mobile Computing* 8(5), 606–621.
- Díaz, J., J. Petit, M. Serna, and L. Trevisan. 2001. Approximating layout problems on random graphs. *Discrete Mathematics* 235(1-3), 245–253.
- Duda, A.. 2008. Understanding the Performance of 802.11 Networks. In *2008 IEEE 19th International Symposium on Personal, Indoor and Mobile Radio Communications*, pp. 1–6. IEEE.
- Gao, J., Y. Shen, X. Jiang, O. Takahashi, and N. Shiratori. 2013. End-to-End Delay Modeling for Mobile Ad Hoc Networks: A Quasi-Birth-and-Death Approach. *Adhoc & Sensor Wireless Networks* 29(1-4), 265–285.
- Glauche, I., W. Krause, R. Sollacher, and M. Greiner. 2003. Continuum percolation of wireless ad hoc communication networks. *Physica A: Statistical Mechanics and its Applications* 325(3), 577–600.
- Guo, S., M. Guo, and V. Leung. 2009. Exploring the multicast lifetime capacity of WANETs with directional multibeam antennas. In *IEEE INFOCOM 2009*, pp. 2686–2690. IEEE.
- Guo, S., M. Guo, and V. C. M. Leung. 2014. On the Multicast Lifetime of WANETs with Multibeam Antennas : Formulation , Algorithms , and Analysis. *IEEE Transactions on Computers* 63(8), 1988–2001.

- Gupta, G. A., S. Toumpis, J. Sayir, and R. R. Müller. 2008. On the transport capacity of gaussian multiple access and broadcast channels. *Wireless Networks* 14(5), 573–590.
- Gupta, P. and P. R. Kumar. 1998. *Critical Power for Asymptotic Connectivity in Wireless Networks*, pp. 547–566. Springer.
- Hekmat, R.. 2006. *Ad-hoc networks: fundamental properties and network topologies*. Springer Science & Business Media.
- Hekmat, R. and P. V. Mieghem. 2003. Degree distribution and hopcount in wireless ad-hoc networks. In *Proc. IEEE ICON*, pp. 603–609.
- Hekmat, R. and P. Van Mieghem. 2006. Connectivity in wireless ad-hoc networks with a log-normal radio model. *Mobile Networks and Applications* 11(3), 351–360.
- IEEE. 2012. 802.11-2012 - IEEE Standard for Information technology–Telecommunications and information exchange between systems Local and metropolitan area networks–Specific requirements Part 11: Wireless LAN Medium Access Control (MAC) and Physical Layer (PHY) Sp. (IEEE Std 802.11™-2012).
- Johnson, D. B. and D. A. Maltz. 1996. Dynamic source routing in ad hoc wireless networks. In *Mobile computing*, pp. 153–181. Springer.
- Keshavarzian, A., E. Uysal-Biyikoglu, F. Herrmann, and A. Manjeshwar. 2004. Energy-efficient link assessment in wireless sensor networks. In *Proceedings - IEEE INFOCOM*, Volume 3, pp. 1751–1761. IEEE.
- Khazali, M. J. and M. Karimi. 2013. "A New Model for Secure Routing and Reducing Energy Consumption in Ad-hoc Networks". pp. 140–144.
- Kim, S.-K., J.-H. Yoon, K.-J. Lee, J.-H. Choi, and S.-B. Yang. 2015. "A scalable mobility-based replica allocation scheme in a mobile ad-hoc network". *Telecommunication Systems* 60(2), 239–250.
- Ko, Y. and N. H. Vaidya. 2000. Location-Aided Routing (LAR) in mobile ad hoc networks. *Wireless Networks* 6(4), 307–321.
- Ko, Y.-B., V. Shankarkumar, and N. H. Vaidya. 2000. Medium access control protocols using directional antennas in ad hoc networks. In *INFOCOM 2000. Nineteenth Annual Joint Conference of the IEEE Computer and Communications Societies. Proceedings. IEEE*, Volume 1, pp. 13–21 vol.1.
- Kranakis, E., D. Krizanc, and E. Williams. 2005, dec. Directional Versus Omnidirectional Antennas for Energy Consumption and k-Connectivity of Networks of Sensors. In *International Conference On Principles Of Distributed Systems*, pp. 357–368. Springer, Berlin, Heidelberg.

- Kuhn, F., R. Wattenhofer, Y. Zhang, and A. Zollinger. 2003. Geometric ad-hoc routing: of theory and practice. pp. 63–72.
- Lee, A. and I. Ra. 2015. Network resource efficient routing in mobile ad hoc wireless networks. *Telecommunication Systems*, 1–9.
- Leung, K. K. and E. Hossain. 2007. *Wireless Mesh Networks: Architectures, Protocols, Services and Applications*. Springer.
- Li, J., J. Jannotti, D. S. J. De Couto, D. R. Karger, and R. Morris. 2000. "A scalable location service for geographic ad hoc routing". In *Proceedings of the 6th annual international conference on Mobile computing and networking - MobiCom '00*, Address, pp. 120–130. ACM.
- Li, P., C. Zhang, and Y. Fang. 2011. The capacity of wireless ad hoc networks using directional antennas. *IEEE Transactions on Mobile Computing* 10(10), 1374–1387.
- Liu, B., B. Rong, R. Hu, and Y. Qian. 2013, dec. Neighbor discovery algorithms in directional antenna based synchronous and asynchronous wireless ad hoc networks. *IEEE Wireless Communications* 20(6), 106–112.
- Mahfoudh, S. and P. Minet. 2010. Energy-aware routing in wireless ad hoc and sensor networks. *Proceedings of the 6th International Wireless Communications and Mobile Computing Conference on ZZZ - IWCMC '10*, 1126.
- Maker, J. and I. Chakeres. 2000. IETF Mobile Ad-hoc Networks (Manet) Working Group.
- Malek, A. G., C. Li, L. Layuan, and W. Bo. 2010. New energy model: Prolonging the lifetime of Ad-hoc On-Demand Distance Vector Routing Protocols (AODV). *Proceedings of the 2010 2nd International Conference on Future Computer and Communication, ICFCC 2010* 2(v), 426–429.
- Marbach, P.. 2008. Transmission costs, selfish nodes, and protocol design. *Wireless Networks* 14(5), 615–631.
- MathWorks. 2012. Network Analysis and Visualization, Bioinformatics Tollbox - MATLAB.
- MathWorks, T.. 1998. Guide, M.U. Inc., Natick, MA 5.
- Mauve, M., J. Widmer, and H. Hartenstein. 2001. "A survey on position-based routing in mobile ad hoc networks". *IEEE Network* 15(6), 30–39.
- McGlynn, M. and S. Borbash. 2001. Birthday protocols for low energy deployment and flexible neighbor discovery in ad hoc wireless networks. In *Proceedings of the 2nd ACM international symposium on Mobile ad hoc networking & computing - MobiHoc '01*, Volume 4, pp. 137. ACM.
- Microchip. 2016. MRF24WG0MA - Wireless Modules.

- Mihail, S. L.. 2005. Wireless Mesh Networks: Opportunities And Challenges. In *Proc of the Wireless World Congress*, Volume 2, Address, pp. 1–6.
- Modeler, O.. 2003. Opnet Technologies. *Inc.*, <http://www.mil3.com>.
- Molisch, A. F.. 2011. *Wireless Communications*, Volume 2. prentice hall PTR New Jersey.
- Morris, R., J. Jannotti, F. Kaashoek, J. Li, and D. Decouto. 2000. Carnet: A scalable ad hoc wireless network system. In *Proceedings of the 9th workshop on ACM SIGOPS European workshop: beyond the PC: new challenges for the operating system*, Address, pp. 61–65. ACM.
- Murthy, S. R. and B. S. Manoj. 2004. *Ad hoc Wireless Networks, Architectures and protocols*. Prentice Hall.
- Nasipuri, A., J. Mandava, H. Manchala, and R. E. Hiramoto. 2000. On-demand routing using directional antennas in mobile ad hoc networks. In *Computer Communications and Networks, 2000. Proceedings. Ninth International Conference on*, pp. 535–541.
- Nasipuri, A., S. Ye, J. You, and R. Hiramoto. 2000. "A MAC protocol for mobile ad hoc networks using directional antennas". In *2000 IEEE Wireless Communications and Networking Conference. Conference Record (Cat. No.00TH8540)*, Volume 3, pp. 1214–1219.
- Németh, G. and G. Vattay. 2003, mar. Giant clusters in random ad hoc networks. *Physical Review E* 67(3), 36110.
- Newman, M., S. Strogatz, and D. Watts. 2001. Random graphs with arbitrary degree distributions and their applications. *Physical review E*.
- Noordin, N. H., V. Zuniga, A. O. El-Rayis, N. Haridas, A. T. Erdogan, and T. Arslan. 2011. Uniform circular arrays for phased array antenna. *LAPC 2011 - 2011 Loughborough Antennas and Propagation Conference* (November), 1–4.
- Park, J.-S., S.-W. Cho, M. Y. Sanadidi, and M. Gerla. 2009. "An analytical framework for neighbor discovery strategies in ad hoc networks with sectorized antennas". *IEEE Communications Letters* 13(11), 832–834.
- Perkins, C., E. Belding-Royer, and S. Das. 2003. Ad hoc on-demand distance vector (AODV) routing. Technical report.
- Piret, P.. 1991. On the connectivity of radio networks. *IEEE Transactions on Information Theory* 37(5), 1490–1492.
- Quintero, A., D. Y. Li, and H. Castro. 2007. "A location routing protocol based on smart antennas for ad hoc networks". *Journal of Network and Computer Applications* 30(2), 614–636.

- Rafique, M. I. and T. Bauschert. 2012. Path Selection and Adaptive Selection of Smart Antenna Transmission Schemes in Multi-hop Wireless Networks. pp. 12–22.
- Ram, G., D. Mandal, R. Kar, and S. P. Ghoshal. 2017, may. Opposition-based BAT algorithm for optimal design of circular and concentric circular arrays with improved far-field radiation characteristics. *International Journal of Numerical Modelling: Electronic Networks, Devices and Fields* 30(3-4), e2087.
- Ramanathan, R.. 2001. On the performance of ad hoc networks with beamforming antennas. In *Proceedings of the 2nd ACM international symposium on Mobile ad hoc networking & computing*, pp. 95–105. ACM.
- Ramanathan, R.. 2004. *Antenna Beamforming and Power Control for AD HOC Networks*.
- Ramanathan, R., J. Redi, C. Santivanez, D. Wiggins, and S. Polit. 2005. "Ad hoc networking with directional antennas: a complete system solution". In *2004 IEEE Wireless Communications and Networking Conference (IEEE Cat. No.04TH8733)*, Volume 23, pp. 375–380 Vol.1.
- Rappaport, T. and C. Liberti. 1999. Smart Antennas for Wireless Communications: IS-95 and Third Generation CDMA application. In *Prentice Hall, Upper Saddle River*, Chapter 1, pp. 32–34. Prentice Hall PTR.
- Rappaport, Theodore. 2002. *Wireless Communications: Principles and Practice*, Volume 2. prentice hall PTR New Jersey.
- Raviteja, G. V., K. Sridevi, V. Malleswara Rao, and A. J. Rani. 2016. Synthesis of Adaptive Uniform Circular Array Using Normalized Fractional Least Mean Squares Algorithm. *American Journal of Signal Processing* 6(1), 14–18.
- Rodoplu, V. and T. H. Meng. 1999. Minimum energy mobile wireless networks. *IEEE Journal on Selected Areas in Communications* 17(8), 1333–1344.
- Rong, B., Y. Qian, K. Lu, R. Hu, and M. Kadoch. 2010. Multipath routing over wireless mesh networks for multiple description video transmission. *Selected Areas in Communications, IEEE Journal on* 28(3), 321–331.
- Roy, S., Y. C. Hu, D. Peroulis, and X.-Y. Li. 2006. Minimum-Energy Broadcast Using Practical Directional Antennas in All-Wireless Networks. In *INFOCOM*. Citeseer.
- Royer, E. M. and C.-K. Toh. 1999. "A review of current routing protocols for ad hoc mobile wireless networks". *IEEE personal communications* 6(2), 46–55.
- Sarkar, S. and R. Datta. 2012. "A trust based protocol for energy-efficient routing in self-organized MANETs". *2012 Annual IEEE India Conference, INDICON 2012*, 1084–1089.

- Sharma, S.. 2009. P-OLSR: Position-based optimized link state routing for mobile ad hoc networks. In *2009 IEEE 34th Conference on Local Computer Networks*, Address, pp. 237–240. IEEE.
- Simek, M. and P. Moravek. 2011. Modeling of Energy Consumption of Zigbee Devices in Matlab Tool. *Elektrorevue* 2(3), 41–46.
- Simon, V. and A. Kókuti. 2015. Location based multihop communication in mobile ad hoc networks. *Telecommunication Systems* 59(4), 523–530.
- Singh, S. and C. S. Raghavendra. 1998, jul. PAMAS—power aware multi-access protocol with signalling for ad hoc networks. *ACM SIGCOMM Computer Communication Review* 28(3), 5–26.
- Solheid, A.. 2005. AODV enhanced by Smart Antennas. *Fundp.Ac.Be*.
- Spyropoulos, A. and C. Raghavendra. 2002. Energy efficient communications in ad hoc networks using directional antennas. In *Proceedings.Twenty-First Annual Joint Conference of the IEEE Computer and Communications Societies*, Volume 1, pp. 220–228. IEEE.
- Swaminathan, A., D. L. Neneaker, and H. B. Russell. 2012. The design of a channel-access protocol for a wireless ad hoc network with sectorized directional antennas. *Ad Hoc Networks* 10(3), 284–298.
- Takai, M., J. Martin, R. Bagrodia, and A. Ren. 2002. Directional virtual carrier sensing for directional antennas in mobile ad hoc networks.
- Temel, S. and I. Bekmezci. 2015. LODMAC: Location oriented directional MAC protocol for FANETs. *Computer Networks* 83, 76–84.
- U. of Hawaii. 2007. Antenna Introduction / Basics 1.
- Vasudevan, S., M. Adler, D. Goeckel, and D. Towsley. 2013. Efficient Algorithms for Neighbor Discovery in Wireless Networks. *Networking, IEEE/ACM Transactions on* 21(1), 1–18.
- Vasudevan, S., J. Kurose, and D. Towsley. 2005. On neighbor discovery in wireless networks with directional antennas. In *Proceedings IEEE 24th Annual Joint Conference of the IEEE Computer and Communications Societies.*, Volume 4, pp. 702–710.
- Voorhaen, M. and C. Blondia. 2006. "Analyzing impact of neighbor sensing on performance of OLSR protocol". In *2006 4th International Symposium on Modeling and Optimization in Mobile, Ad Hoc and Wireless Networks, WiOpt 2006*, pp. 1–6.
- Wang, Y., B. Liu, and L. Gui. 2013. "Adaptive Scan-based Asynchronous Neighbor Discovery in Wireless Networks Using Directional Antennas". In *Wireless Communications & Signal Processing (WCSP), 2013 International Conference on*, pp. 0–5. IEEE.

- Wieselthier, J., G. Nguyen, and A. Ephremides. 2000. On the construction of energy-efficient broadcast and multicast trees in wireless networks. In *Proceedings IEEE INFOCOM 2000. Conference on Computer Communications. Nineteenth Annual Joint Conference of the IEEE Computer and Communications Societies (Cat. No.00CH37064)*, Volume 2, pp. 585–594. IEEE.
- Winters, J. H.. 2006. Smart antenna techniques and their application to wireless ad hoc networks. *IEEE Wireless Communications* 13(4), 77–83.
- Yi, S., Y. Pei, and S. Kalyanaraman. 2003. On the capacity improvement of ad hoc wireless networks using directional antennas. In *Proceedings of the 4th ACM international symposium on Mobile ad hoc networking & computing*, pp. 108–116. ACM.
- Yi, S., Y. Pei, S. Kalyanaraman, and B. Azimi-Sadjadi. 2007. How is the capacity of ad hoc networks improved with directional antennas? *Wireless Networks* 13(5), 635–648.
- Yoon, J., W.-Y. Shin, and S.-W. Jeon. 2014. Elastic routing in wireless networks with directional antennas. *2014 IEEE International Symposium on Information Theory*, 1001–1005.
- Zemlianov, A. and G. de Veciana. 2005. Capacity of ad hoc wireless networks with infrastructure support. *IEEE Journal on selected areas in Communications* 23(3), 657–667.
- Zhang, Z. and B. Li. 2008. Neighbor discovery in mobile ad hoc self-configuring networks with directional antennas: Algorithms and comparisons. *IEEE Transactions on Wireless Communications* 7(5), 1540–1549.
- Zhou, X., H. M. Jones, S. Durrani, and A. Scott. 2007. Effect of beamforming on the connectivity of ad hoc networks. *Proc. AusCTW*, 13–18.
- Zhu, J., C. Qiao, and X. Wang. 2006, nov. On Accurate Energy Consumption Models for Wireless Ad Hoc Networks. *IEEE Transactions on Wireless Communications* 5(10), 3077–3086.
- Zhu, J. and X. Wang. 2011. Model and protocol for energy-efficient routing over mobile Ad Hoc Networks. *IEEE Transactions on Mobile Computing* 10(11), 1546–1557.